

H6 Handy Recorder

Operation Manual



© 2013 ZOOM CORPORATION

Reproduction of this manual in whole or in part by any means without permission is prohibited.



Usage and safety precautions

SAFETY PRECAUTIONS

In this operation manual, symbols are used to highlight warnings and cautions that you must read to prevent accidents. The meanings of these symbols are as follows.

	Something that could cause serious injury or death
	Something that could cause injury or damage to the equipment

Other symbols used

	An action that is mandatory
	An action that is prohibited

Warnings

Operation using an AC adapter

- ❗ Use only a ZOOM AD-17 AC adapter (sold separately) with this unit.
- ⊘ Do not do anything that could exceed the ratings of outlets and other electrical wiring equipment.

Do not use with power other than AC 100V. Before using the equipment in a foreign country or other region with a power voltage other than AC100V, always consult with a shop that carries ZOOM products and use the appropriate AC adapter.

Operation using batteries

- ❗ Use 4 conventional 1.5-volt AA batteries (alkaline or nickel-metal hydride).
- ❗ Read battery warning labels carefully.
- ❗ Always close the battery compartment cover when using the unit.

Alterations

- ⊘ Do not open the case or modify the product.

Precautions

Product handling

- ❗ Do not drop, bump or apply excessive force to the unit.
- ❗ Be careful not to allow foreign objects or liquids enter the unit.

Operating environment

- ⊘ Do not use in extremely high or low temperatures.
- ⊘ Do not use near heaters, stoves and other heat sources.
- ⊘ Do not use in very high humidity or where it could be splashed by water.
- ⊘ Do not use in places with frequent vibrations.
- ⊘ Do not use in places with much dust or sand.

AC adapter handling

- ❗ When disconnecting the power plug from an outlet, always hold the plug when pulling.
- ❗ Disconnect the power plug from the outlet during lightning storms and when not using the unit for a long time.

Battery handling

- ❗ Install the batteries with the correct +/- orientation.
- ❗ Use a specified battery type. Do not mix new and old batteries or different brands or types at the same time.
- ❗ When not using the unit for an extended period of time, remove the batteries.
- ❗ If a battery leak should occur, wipe the battery compartment and the battery terminals carefully to remove all residue.

Mics

- ❗ Before connecting a mic, always turn the power off. Do not use excessive force when connecting a unit
- ❗ When not using a mic for a long time, put the protective cap on.

Connection cables and input/output jacks

- ❗ Always turn the power OFF for all equipment before connecting any cables.
- ❗ Always disconnect all connection cables and the AC adapter before moving the unit.

Volume

- ⊘ Do not use at a loud volume for a long time.

Usage Precautions

Interference with other electrical equipment

In consideration of safety, the **H6** has been designed to minimize its emission of electromagnetic waves and to suppress interference from external electromagnetic waves. However, equipment that is very susceptible to interference or that emits powerful electromagnetic waves could result in interference if placed nearby. If this occurs, place the **H6** and the other device farther apart.

With any type of electronic device that uses digital control, including the **H6**, electromagnetic interference could cause malfunction, corrupt or destroy data and result in other unexpected trouble. Always use caution.

Cleaning

Use a soft cloth to clean the exterior of the unit if it becomes dirty. If necessary, use a damp cloth that has been wrung out well. Never use abrasive cleansers, wax or solvents such as alcohol, benzene or paint thinner.

Breakdown and malfunction

If the unit becomes broken or malfunctions, immediately disconnect the AC adapter, turn the power OFF and disconnect other cables. Contact the store where you bought the unit or ZOOM service with the following information: product model, serial number and specific symptoms of breakdown or malfunction, along with your name, address and telephone number.

Copyrights

- © Windows®, Windows® 8, Windows® 7, Windows Vista® and Windows® XP are trademarks or registered trademarks of Microsoft Corporation.
 - © Macintosh, Mac OS and iPad are trademarks or registered trademarks of Apple Inc.
 - © The SD, SDHC and SDXC logos are trademarks.
 - © The use of MPEG Layer-3 audio compression technology is licensed from Fraunhofer IIS and Sisvel SpA.
 - © All other product names, trademarks and company names in this document are the property of their respective owners.
- Note: All trademarks and registered trademarks in this document are for identification purposes only and are not intended to infringe on the copyrights of their respective owners.

Recording for any purpose other than personal use from copyrighted sources, including CDs, records, tapes, live performances, video works and broadcasts, without permission of the copyright holder is prohibited by law. Zoom Corporation will not assume any responsibility related to infringements of copyrights.

Introduction

Thank you very much for purchasing a ZOOM **H6** Handy Recorder. The **H6** has the following features.

● Stereo mics can be changed according to use

An XY mic that can record sound images with depth and an MS mic that allows the stereo width to be adjusted freely are included. You can switch mics according to the situation as you would switch lenses on an SLR camera.

Options include a highly-directional shotgun mic and an external XLR/TRS input.

● Record up to 6 track at once

In addition to the swappable stereo mic (L/R input), the main unit has 4 XLR/TRS inputs (Inputs 1–4).

Use these to simultaneously record a maximum of 6 tracks, including ambiance, narration, a stereo image and the voices of multiple performers, for example.

● Advanced recording features

- The XY mic, which has newly-developed 14.6mm large diaphragm mics, records the full range of frequencies with good stereo placement.
- Using the L/R input mics, you can simultaneously record a backup file with a recording level that is 12 dB less than the regular recording. You can use this backup recording if an unexpected loud noise should cause the regular recording to distort, for example.

- Inputs 1–4 have increased maximum gain compared to previous models. In response to popular demand, they have independent **PAD** switches that allow them to easily handle +4dB input. They can also provide phantom power (+12V/+24V/+48V).
- All input volume (gain) levels can be adjusted quickly by hand using dedicated knobs.

● Useful operation features

- High-capacity SDXC cards can be used as recording media, allowing even longer recording times.
- The color LCD is positioned to be easy to read even when mounted on an SLR camera.
- In addition to the standard headphones output, a line output jack is built-in. This allows you to send the audio signal to a video camera or other device while monitoring with headphones.
- When the **H6** is connected by USB, in addition to card reader functions, it can be used as an audio interface that is either 2 IN and 2 OUT or 6 IN and 2 OUT (driver required for 6 IN use with Windows).
- Of course, a tuner, a metronome and playback speed and pitch adjustments are included among the useful functions that are also found in other models in the H series.
- An optional remote control (wired) is also available.

Please read this manual carefully to fully understand the functions of the **H6** so that you can make the most of it for many years. After reading the manual, please keep it with the warranty in a safe place.

Contents

Usage and safety precautions.....	02
Introduction	03
Contents	04
Included items	05
Names of parts	06
Mic overview	08
XY mic.....	08
MS mic.....	08
Connecting and disconnecting mics	09
Mic connection	09
Mic disconnection	09
Connecting mics/other devices to Inputs 1–4	10
Connecting mics.....	10
Connecting instruments/other devices.....	10
Stereo inputs	10
Connection examples	11
Optional accessories	12
Display overview	14
Home/Recording Screen	14
Playback Screen	15
Preparations	
Supplying power	16
Using batteries	16
Using an AC adapter (sold separately)	17
Loading an SD card.....	18
Turning the power on and off.....	19
Turning the power on.....	19
Turning the power off	19
Using the hold function	20
Activating the hold function.....	20
Deactivating the hold function.....	20
Setting the language.....	21
Setting the date and time	22
Setting the type of battery used.....	23

Recording

Recording process.....	24
Folder and file structure.....	25
Basic recording.....	26
Selecting the folder where projects are saved	28
Recording automatically.....	29
Pre-recording	31
Counting in before recording	32
Adjusting the side mic level	33
Backup recording	34
Overdubbing.....	35

Playback

Basic playback	38
Select the playback project from the list	40
Changing the playback speed	41
Repeat playback of a set interval (AB repeat)	42
Changing the playback mode.....	44
Changing the playback pitch (key)	45
Mixing	46

Checking/editing projects/files

Checking project information	48
Checking track marks	49
Changing project names.....	50
Mixing down a project.....	52
Normalizing tracks	54
Dividing projects	56
Trimming project beginnings and ends	58
Deleting one project.....	60
Deleting all projects in a folder	61
Rebuilding a project.....	62
Recording a project voice memo	63
Playing backup files	64

USB functions

Data exchange with computers (card reader).....	66
Using as an audio interface.....	68
Audio interface settings.....	70
Making direct monitoring settings.....	70
Using Loop Back (in stereo mix mode)	71
Mixing the inputs	72

Tools

Using the tuner.....	74
Using the metronome.....	76

Other settings

Reducing noise (low cut filter)	78
Using the input compressor/limiter.....	79
Adjusting the input signal monitoring mix	80
Monitoring MS-RAW signals.....	82
Setting the recording format.....	83
Changing automatic recording settings	84
Enabling automatic stopping	85
Setting how projects are named	86
Changing the phantom power setting.....	87
Using plug-in power	88
Using VU meters to check input levels	89
Setting the display to save power	90
Adjusting the display brightness	91
Checking the firmware versions.....	92
Restoring the default settings	93

Other functions

Checking SD card open space.....	94
Formatting SD cards	95
Testing SD card performance.....	96
Updating the firmware.....	98
Using SD cards from older H series recorders	99
Using a remote control (sold separately).....	100
Troubleshooting	101
Specifications	102

Included items

The package should contain the following items.
Please confirm that they have all been included.

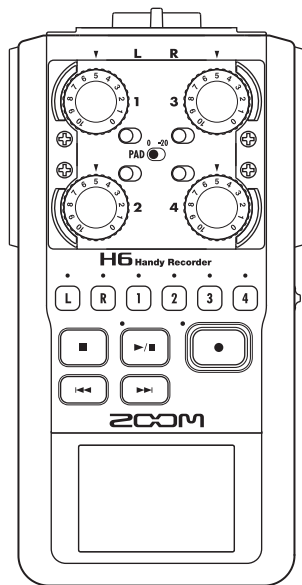

H6 main unit

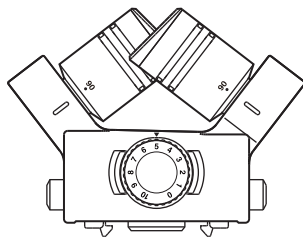

XY mic

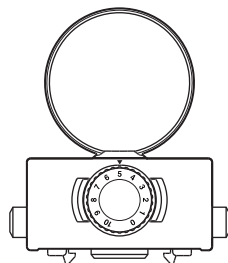

MS mic

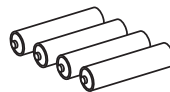

4 AA batteries
(for unit testing)



SD card



USB cable

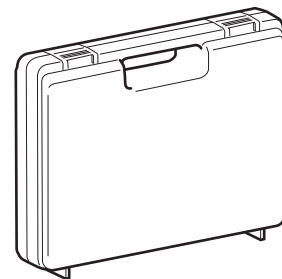

Main unit case

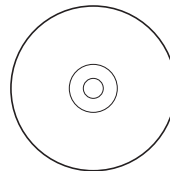

Cubase LE
installation DVD



Operation manual
(this document)



Wind screen
(sponge)

Names of parts

Left

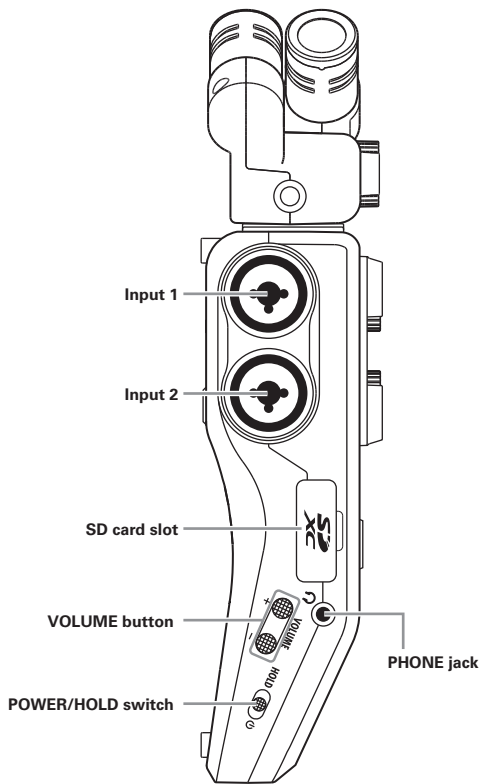

Front

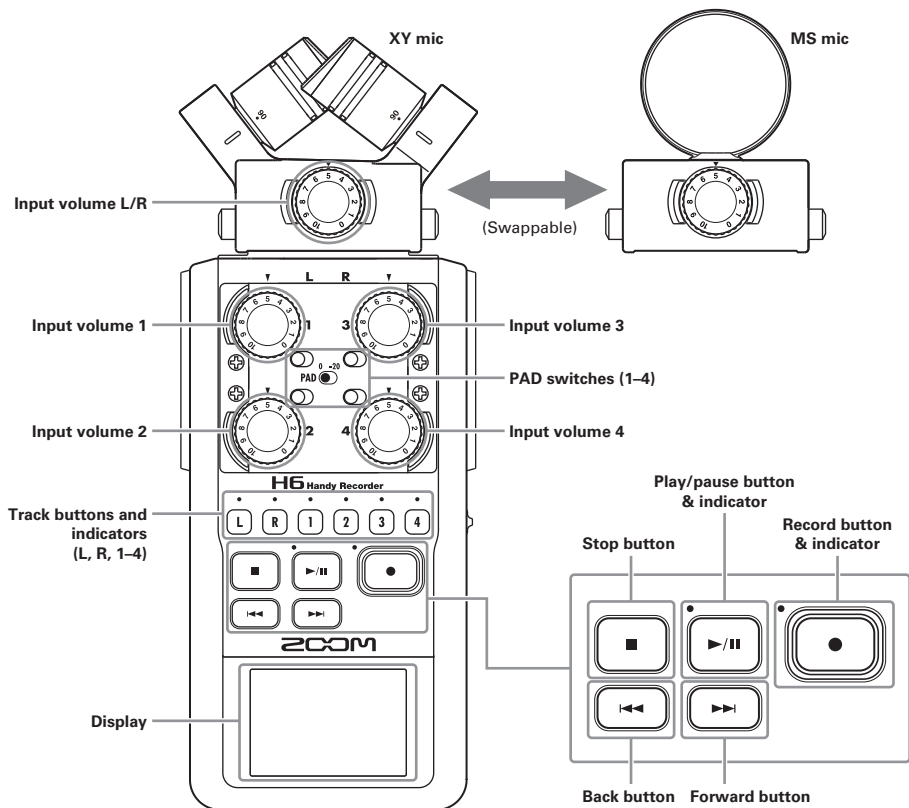

Right (back)

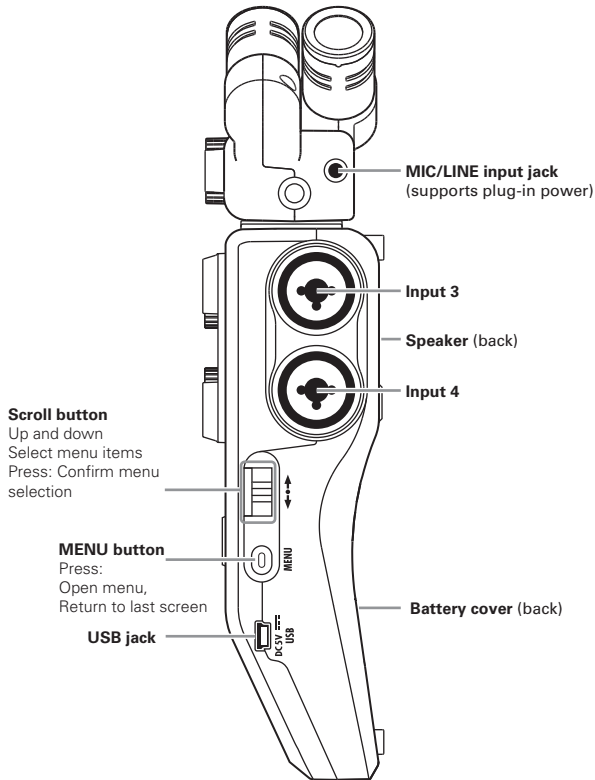

Bottom

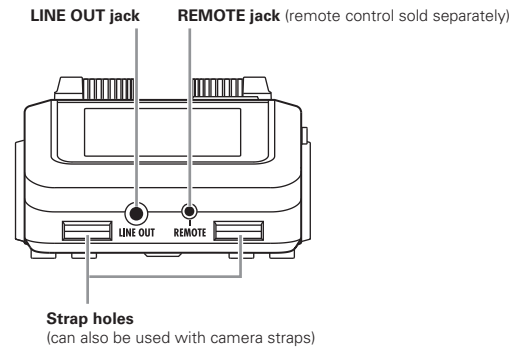

XLR

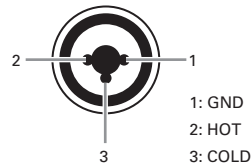

TRS

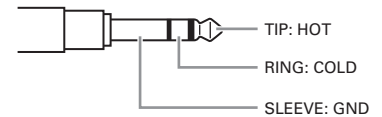

Mic overview

The **H6** includes XY and MS mics. These mics can be swapped according to your need. A shotgun mic (SGH-6) and an external XLR/TRS input (EXH-6) are also available as optional accessories. (→ P.12)
The input from these mics (L/R input) is recorded on the L/R tracks.

XY mic

This has two crossing directional mics.
By rotating the mics, you can switch the width of the recording field between 90° and 120°.

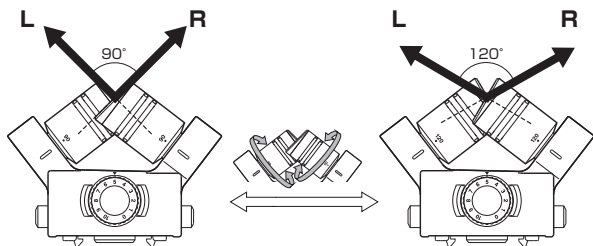

Features:

Newly-developed large diaphragm mics enable low and high frequencies to be recorded with good stereo placement while sounds in the center are captured clearly.

This mic is ideal for recording at close and medium ranges when aimed at specific sound sources to capture a three-dimensional sound with natural depth and width.

Use examples: solo performances, chamber music, live rehearsals, field recording

NOTE

The XY mic has a **MIC/LINE** input jack that can be used to connect an external mic or line-level device. This jack can also provide plug-in power to mics that use it. (→ P.88)

MS mic

This mic combines a unidirectional mid mic that captures sound from the center with a bidirectional side mic that captures sound from the left and right.

By adjusting the side mic level, you can change the stereo width as you like. If you record in MS-RAW mode, you can adjust the side mic level after recording to change the stereo width.

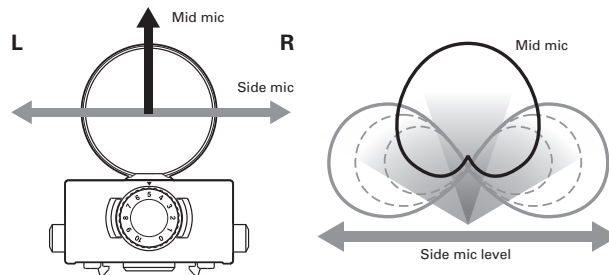

Features:

This mic can capture a wide and detailed stereo image, making it ideal for recording wide open spaces with multiple sound sources.

With the side mic off it can also be used for mono recording.

Use examples: orchestras, live concerts, soundscapes
Use examples with side mic off: interviews, narrations, meetings

Connecting and disconnecting mics

Mic connection

1. Remove the protective caps from the **H6** main unit and the mic.
2. While pressing the buttons on the sides of the mic, connect it to the main unit, inserting the connector completely.

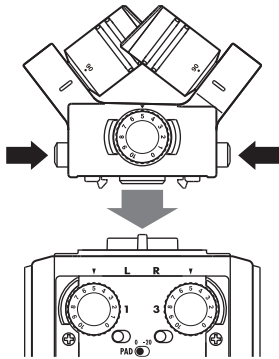

Mic disconnection

1. While pressing the buttons on the sides of the mic, pull it out of the main unit.

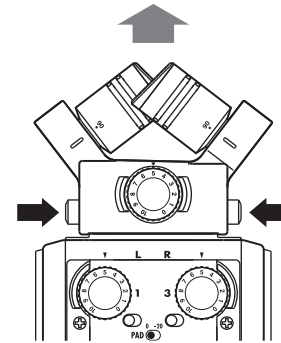

NOTE

- When disconnecting a mic, do not use too much force. Doing so could damage the mic or the main unit.
- Recording will stop if a mic is removed during recording.
- If a mic will not be attached for a long time, put on the protective cap.

Connecting mics/other devices to Inputs 1–4

In addition to the input (L/R) from an XY or MS mic, the **H6** also has **Inputs 1–4**.

These can be used together to record up to six tracks at one time.

Mics, instruments and other equipment can be connected to **Inputs 1–4** and recorded independently to tracks 1–4.

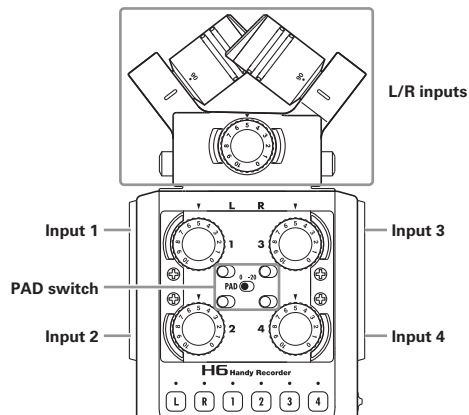

Connecting instruments/other devices

Connect keyboards and mixers directly to the **Input 1–4** TRS jacks.

Direct input of passive guitars and basses is not supported. Connect these instruments through a mixer or effects device, for example.

Set the **PAD** switch to **-20** when connecting a mixer or other device with a standard output level of +4dB.

Stereo inputs

By linking tracks 1 and 2 (or tracks 3 and 4) as a stereo tracks, **Inputs 1/2** (or **Inputs 3/4**) can be used for stereo input. (→ P.26)

In this case, **Input 1** (**Input 3**) becomes the left channel and **Input 2** (**Input 4**) becomes the right channel.

Connecting mics

Connect dynamic mics and condenser mics to the **Input 1–4** XLR jacks.

Phantom power (+12V/+24V/+48V) can be supplied to condenser mics. (→ P.87)

Connection examples

The **H6** allows you to record in a variety of configurations.

While filming

- L/R input mic: Main subject
- Shotgun/lapel mics connected to **Inputs 1/2**: Performer
- Mics connected to **Inputs 3/4**: Ambient sound

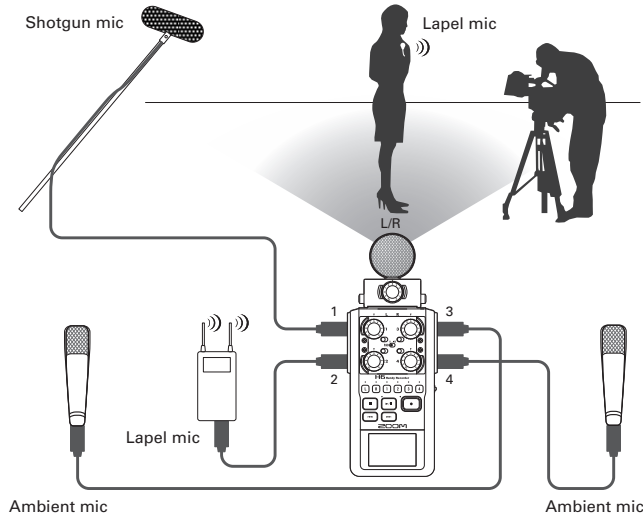

Concert recording

- L/R input mic: Performance on stage
- **Inputs 1/2**: Line outputs from mixer
- Mics connected to **Inputs 3/4**: Audience sound

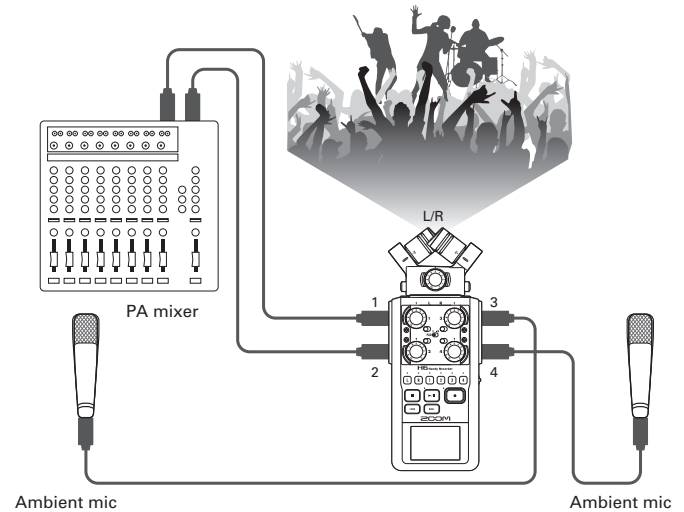

Optional accessories

The following optional accessories are available for use with the **H6**.

Shotgun mic attachment (SGH-6)

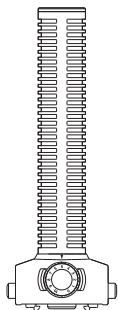

This highly-directional mic is great for capturing mono-
phonic sound from a specific location. Use it in place of an
H6 stereo mic.

- This mic records to the L/R track in mono.

External XLR/TRS input (EXH-6)

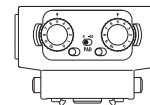

Use instead of a stereo mic to give the **H6** two more XLR/
TRS input jacks (L/R input).

- This does not support phantom power.

Accessory pack (APH-6)

This accessory pack includes the following 3 items: a remote control, a hairy windscreen and an AC adapter.

Remote control (RCH-6)

This is a wired remote control for use with the **H6**. Connect it to the **REMOTE** jack.



Hairy windscreen

This windscreen can be used with both the XY and MS mics.



AC adapter (AD-17)

This AC adapter is designed for use with the **H6**. Connect it to the **USB** jack using a USB cable and plug it into an outlet.

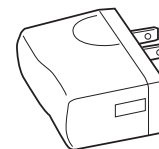

Display overview

Home/Recording Screen

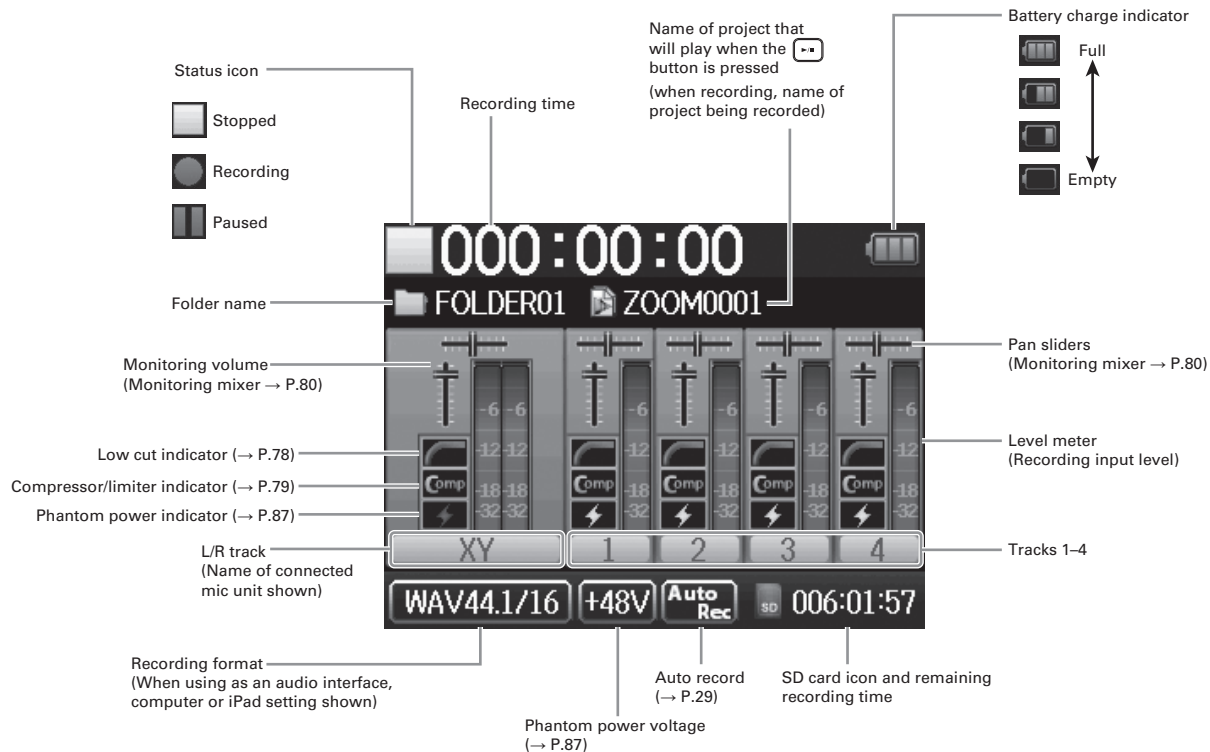

Playback Screen

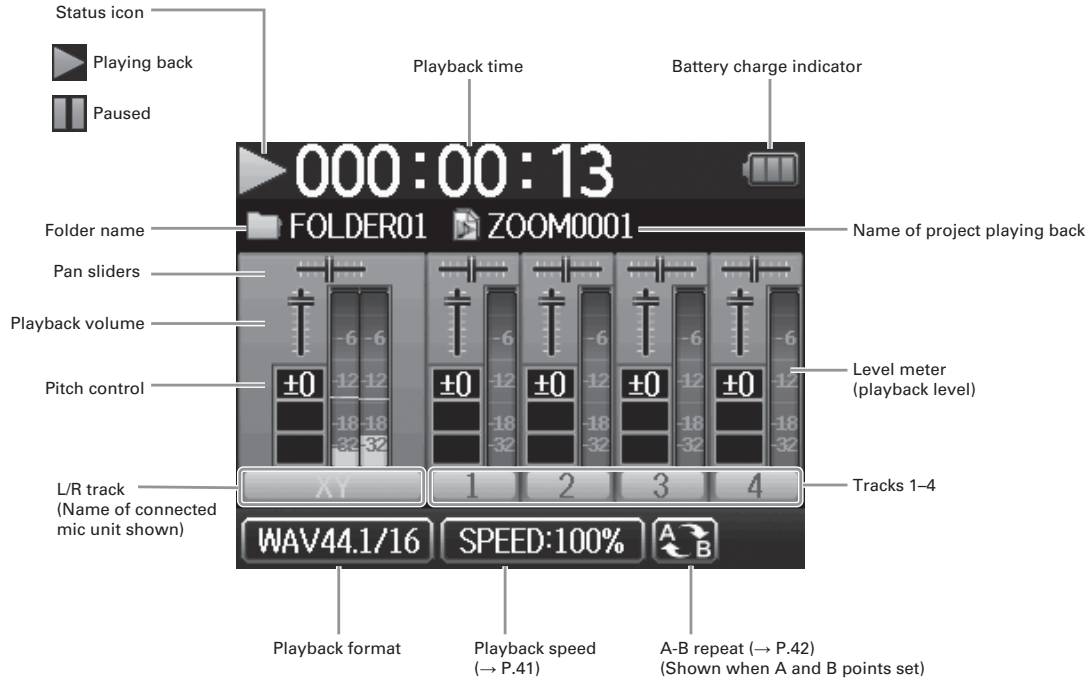

Supplying power

Using batteries

1. Turn the power off and then remove the battery

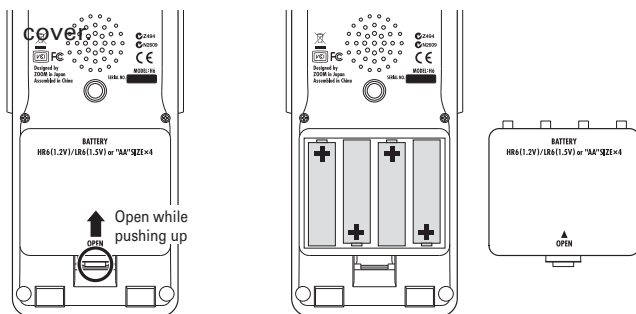

-
2. Install the batteries.
-

3. Replace the battery cover.

NOTE

- Use alkaline batteries or nickel-metal hydride batteries.
- If the battery indicator becomes empty, turn the power off immediately and install new batteries.
- Set the type of battery being used. (→ P.23)



Using an AC adapter (sold separately)

1. Connect a USB cable to the USB jack.

2. Plug the adapter into an outlet.

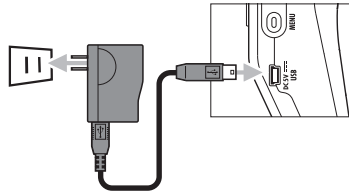

Loading an SD card

1. Turn the power off and then open the SD card slot cover.

2. Insert the card in the slot.

To eject an SD card:

Push the card further into the slot and then pull it out.

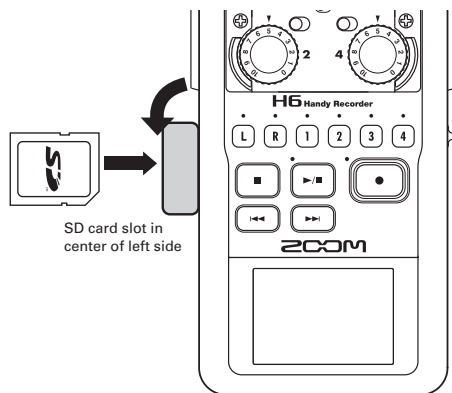

NOTE

- Always turn the power off before inserting or removing an SD card.
Inserting or removing a card while the power is on could result in data loss.
- When inserting an SD card, be sure to insert the correct end with the top side up as shown.
- When an SD card is not loaded, recording and playback are not possible.
- See "Formatting SD cards": (→ P.95)

Turning the power on and off

Turning the power on

- Slide **HOLD**  to the right.

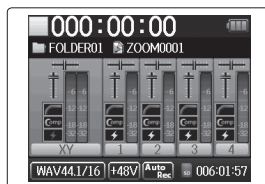

NOTE

- The first time you turn the power on after purchase, you must set the language (→ P.21) and date/time (→ P.22). You can also change these settings later.
- If “No SD Card!” appears on the display, confirm that the SD card is inserted properly.
- If “Card Protected!” appears on the display, the SD card write-protection is enabled. Slide the lock switch on the SD card to disable write-protection.
- If “Invalid Card!” appears on the display, the card is not correctly formatted for use with this recorder. Format the card or use a different card. See “Formatting SD cards” (→ P.95)

Turning the power off

- Slide **HOLD**  to the right.



NOTE

Keep holding the switch to the right until the ZOOM logo appears.

Using the hold function

The **H6** has a hold function that can be used to disable the buttons in order to prevent accidental operation during recording.

Activating the hold function

- Slide HOLD  to the left.



NOTE

The hold function does not affect the remote control (sold separately). Even when hold is active, the remote can still be used.



Deactivating the hold function

- Slide HOLD  to the center.



Setting the language*

The language shown on the display can be set to English or Japanese.

1. Press .

2. Use  to select "LANGUAGE",
and press .



3. Use  to select
the language,
and press .



*The first time you turn the power on after purchase, you must set the language and date/time.

Setting the date and time*

When the date and time are set, the recorder can store accurate recording date and time information in files.

1. Press .

2. Use  to select

“SYSTEM”,

and press .

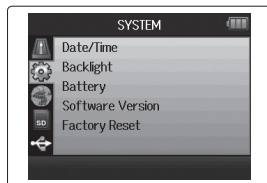

3. Use  to select

“Date/Time”,

and press .

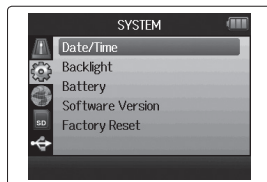

4. Set the date and time.

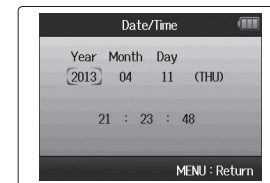

■ Changing settings

Move cursor: Move  up/down

Select item: Press  then move  up/down

Confirm change: Press .



5. Press  to complete the setting.

*The first time you turn the power on after purchase, you must set the language and date/time.



Setting the type of battery used

Set the type of battery used so that the amount of remaining battery charge can be shown accurately.

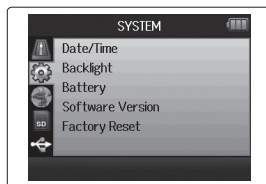

1. Press .

2. Use  to select "SYSTEM", and press .

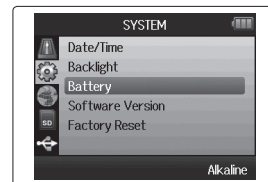

3. Use  to select "Battery", and press .



4. Use  to select the type, and press .

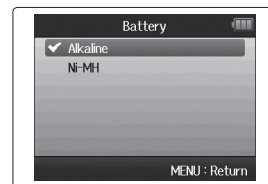

Recording process

The recording process includes the following steps.
With the **H6**, a unit of recording/playback data is called a project.

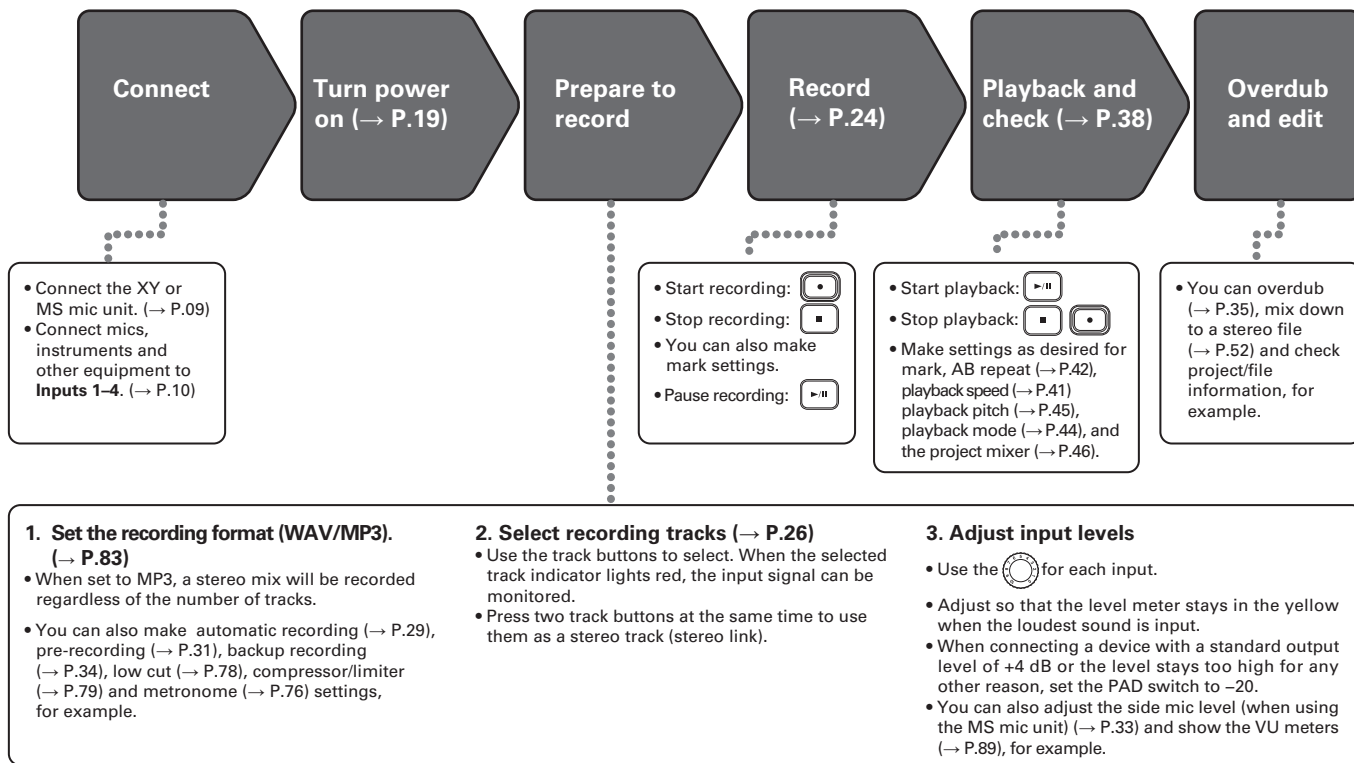

Folder and file structure

When recording with the **H6**, the following folders and files are created on the SD card.

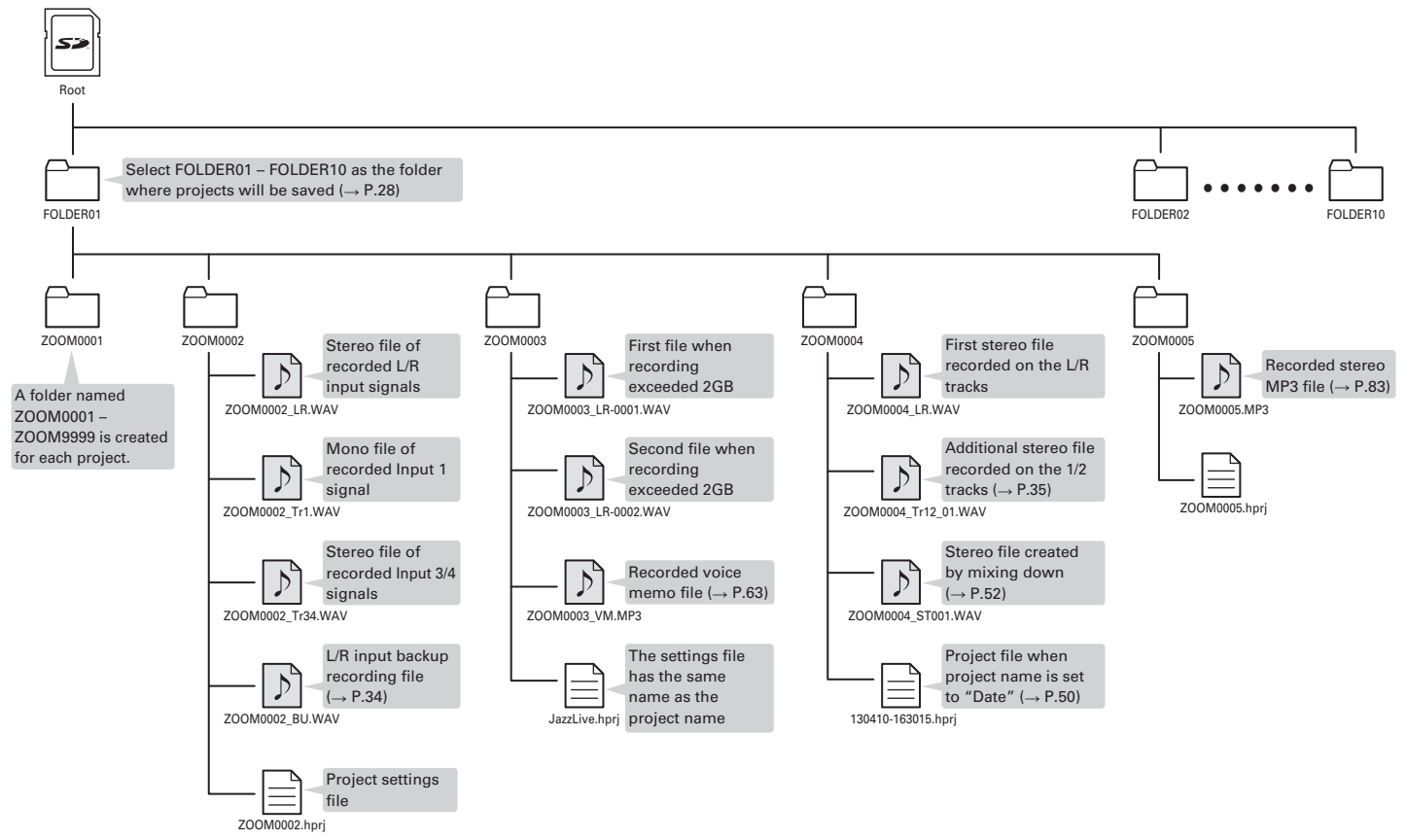

Basic recording

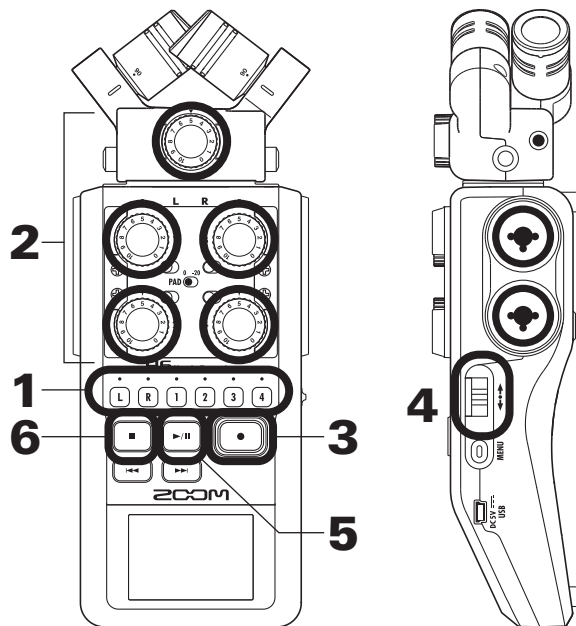

1. Press the button of the track that you want to record.

HINT

- The indicator of the selected track button lights red.
- If you press track button 2 while pressing and holding track button 1, tracks 1/2 will become a stereo track (stereo link). Tracks 3/4 can be made into a stereo track in the same way. Stereo links can also be deactivated in the same way. The L/R track stereo link, however, cannot be deactivated.

HINT

- When recording, files are created for each selected track button as follows.

Tracks recorded	File name	Contents
L/R track	ZOOMnnnn-LR	Stereo file
Mono track	ZOOMnnnn_Tr1 (for track 1)	Mono file
Stereo track	ZOOMnnnn_Tr34 (for tracks 3/4)	Stereo file

Note: "nnnn" in the file name is the project number

- All the files that are created during the same recording are managed by the **H6** as a single project unit.

- 2.** Turn  for the selected input to adjust the input level.

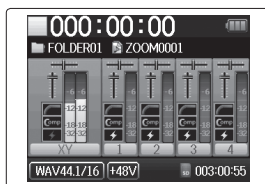
**HINT**

- Adjust so that the peak level stays around -12dB .
- You can change the recording format. (→ P.83)
- You can cut noise from wind and other sources during recording. (→ P.78)

- 3.** Press  to start recording.



- 4.** Press  to add a mark.

- 5.** Press  to pause.

NOTE

When recording is paused, a mark is added at that point.

- 6.** Press  to stop recording.



NOTE

- A maximum of 99 marks can be added to a single project.
- During recording if the file size exceeds 2 GB a new file will be created automatically in the same project and recording will continue without pause. When this happens, numbers will be added to the ends of the file names: "-0001" for the first file, "-0002" for the second file and so on.

Selecting the folder where projects are saved

Choose one of ten folders as the folder where new recorded projects will be saved.

1. Press .

2. Use  to select "PROJECT LIST",
and press .



3. Use  to select the folder where you want to save new projects,
and press .



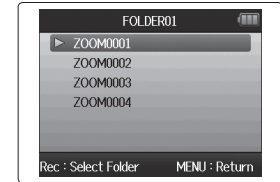

4. Press  to confirm the folder selection and return to the Home Screen.





Recording automatically

Recording can be started and stopped automatically in response to the input level.



1. Press .

2. Use  to select "REC",
and press .

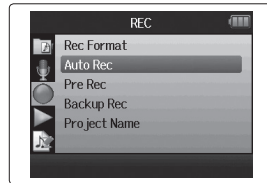

3. Use  to select "Auto
Rec", and press .







4. Use  to select "On/
Off", and press .



NEXT >>>

Recording automatically (continued)

5. Use    to select "On", and press  .



NOTE

For details, see "Changing automatic recording function settings" (→ P.84)

6. Return to the Home

Screen, and press  to put the recorder into standby.



HINT

When the input exceeds the set level (shown on the level meters), recording starts automatically. You can also set the recording to stop automatically when the input goes below a set level. (→ P.85)

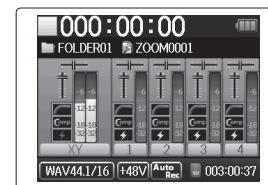

7. Press  to exit standby or stop recording.





Pre-recording

By setting the recorder to constantly capture the input signal, you can start recording two seconds before pressing the  button. This is useful when, for example, a performance starts suddenly.

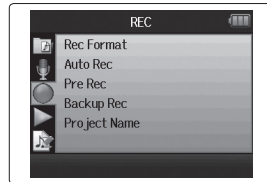

1. Press .

2. Use  to select "REC",
and press .

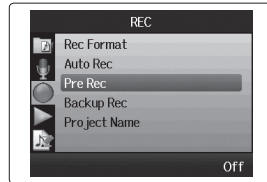

3. Use  to
select "Pre Rec",
and press .



4. Use  to select "On",
and press .

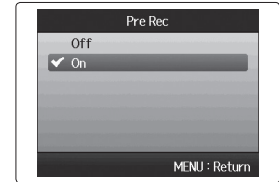



NOTE

The Auto Rec and Pre Count functions cannot be used at the same time as this function.





Counting in before recording

The recorder metronome can be used to count in before starting recording.

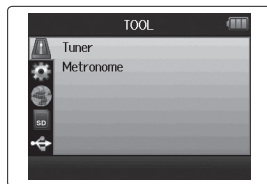



1. Press .

2. Use    to select "TOOL", and press .

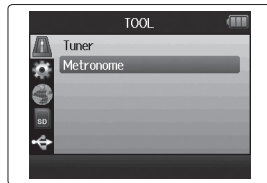





3. Use    to select "Metronome", and press .

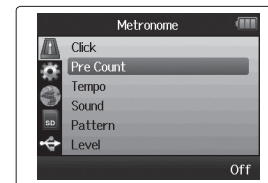

4. Use    to select "Pre Count", and press .



5. Use    to select the count number, and press .

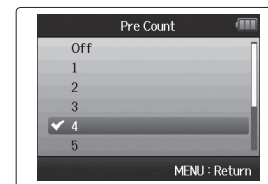

NOTE

The Auto Rec and Pre Rec functions cannot be used at the same time as this function.

Adjusting the side mic level MS mic only

Before using the MS mic to record, you can adjust the side mic level (stereo width).
Do this when the Home Screen is open.

- Move  up and down to adjust.

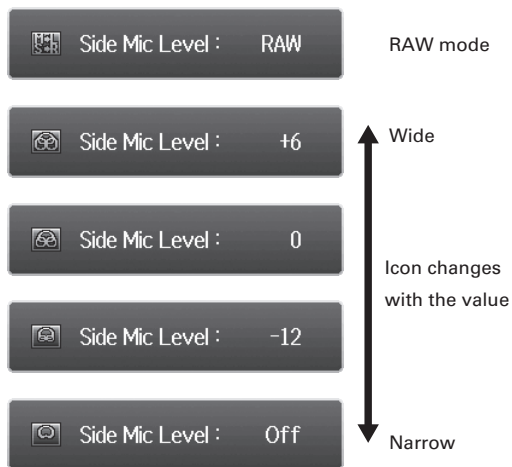

NOTE



- Set to Off, -24 to +6 dB, or RAW.
- When recording in RAW mode, during playback move  up and down to adjust the side mic level.
- RAW mode can be selected only when the WAV format is used for recording.

Backup recording

L/R input and WAV format only

When using the L/R input, in addition to the recording at the set input level, the recorder can also record a separate file at a level 12dB below. This backup can be used if the recording level was set too high, causing distortion, for example.

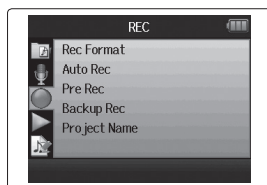

1. Press .

2. Use  to select "REC",
and press .

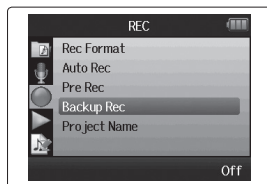

3. Use  to select
"Backup Rec",
and press .



4. Use  to select "On",
and press .

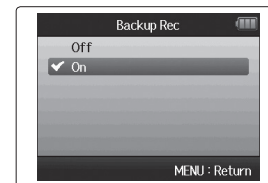

HINT



- If the name of the original file is, for example, "ZOOM0001_LR.wav", the name of the backup file will be "ZOOM0001_BU.wav".
- You can play backup files. (→ P.64)

Overdubbing



WAV format only

You can add recordings to an already recorded project.

1. Press .

2. Use  to select
“PROJECT MENU”,
and press .



3. Use  to select
“Overdub”,
and press .



4. Press the track button
until the indicator lights
red for the track to be
overdubbed.



5. Turn  to adjust the input level.

HINT

You can also adjust the mixer (volume/pan) (→ P.46), low cut filter (→ P.78) and compressor/limiter as needed (→ P.79).

6. To monitor already recorded tracks, press their track buttons so their indicators light green.

NEXT >>>



Overdubbing (continued) WAV format only

7. Press  to start recording.

8. Press  to stop recording.

HINT

- You can change the stereo link setting even during overdubbing.
- Overdub files and volume, pan and stereo link settings are saved in units called "takes". You can change settings and record multiple takes.

Then, when stopped you can press  to select the previous take or press  to select the next take.

- A maximum of 99 takes can be recorded.
- If you want to monitor the input sound of the track while playing back an already recorded track, press the button for the track that you want to monitor so that its indicator lights orange and then press .
- If the playback speed of a project is set to any value other than 100%, tracks cannot be overdubbed (their indicators will not light red).

9. Press  to stop overdubbing.

When you play back or edit an overdubbed project, the last selected take will be used.

NOTE

Two digit take numbers are added to the ends of track names to create file names for overdubbed recordings as in, for example, "ZOOM0001_LR_01.WAV".

Basic playback

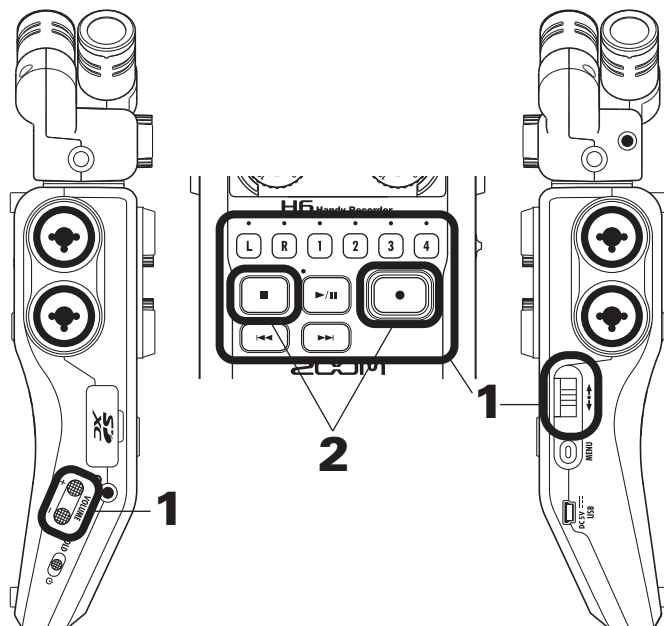

1. Press to start playback.

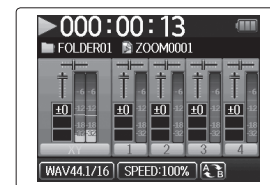

■ Controls during playback

Select project/move to mark: Use and

Search forward/backward: Press and hold /

Pause/resume playback: Press



Adjust volume: Press (+/-)

Add marks: Press

Change side mic level: (RAW mode only) Move up and down

HINT

- The longer you press and hold or , the faster searching backward/forward becomes.
- During playback you can press track buttons to unmute (lit green) and mute (unlit) tracks.

2. Press  or  to return to the Home Screen.

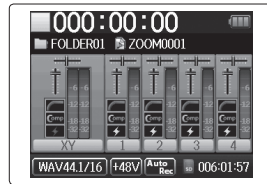



Select the playback project from the list



1. Press  STOP

2. Use  to select "PROJECT LIST", and press .



3. Use  to select the folder, and press .



4. Use  to select the project you want to play back, and press .

The selected project will start playing back.

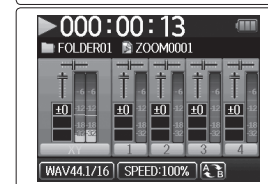

NOTE

After playback completes, playback might continue depending on the playback mode. (→ P.44)



Changing the playback speed

You can adjust the playback speed in a range from 50% to 150% of normal.



1. Press .

2. Use  to select
"PROJECT MENU",
and press .



3. Use  to select
"Playback Speed",
and press .



4. Use  to adjust the
playback speed,
and press .

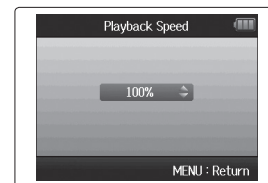

Playback will occur at the adjusted speed.

NOTE

This setting is saved separately for each project.



Repeat playback of a set interval (AB repeat)

You can repeat playback between two set points.



1. Press .

2. Use  to select "PLAY",
and press .





3. Use  to select
"AB Repeat", and
press .

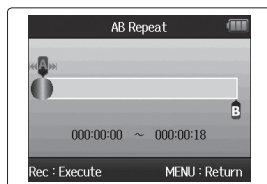

4. Use  to select
the A point icon,
and press .



5. Use  and  to find
the starting point for
repeat playback.
You can also press  to
search while playing back.

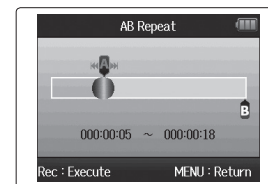

6. Use  to select the B
point icon. Then, set the
repeat playback ending
point.

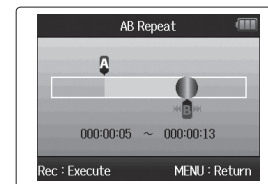

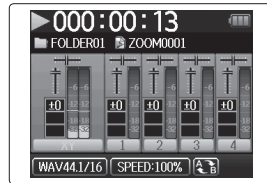

7. Press  to open the playback screen.

Repeat playback will start between the set points.





NOTE

- To end AB repeat playback, follow the instructions on P.42 to select "AB Repeat" and then press .
- During repeat playback, AB repeat will end if you press  or  to select a different project.







Changing the playback mode

You can set the playback mode.







1. Press .

2. Use     to select "PLAY", and press   .



3. Use     to select "Play mode", and press   .



4. Use     to select the mode, and press   .





NOTE

- Play All: Play all the projects in the current folder.
- Play One: Play only the selected project.
- Repeat One: Play the selected project repeatedly.
- Repeat All: Play all the projects in the current folder repeatedly.

Changing the playback pitch (key)

The pitch can be changed in semitones for each track separately while keeping the same playback speed.



1. Press .

2. Use  to select
“PROJECT MENU”,
and press .





3. Use  to select
“Project Mixer”,
and press .

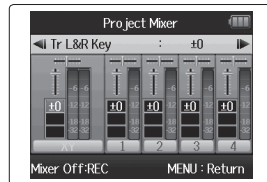

4. Use  to select the
track for which you want
to change the pitch (key),
and press .



5. Use  to set the play-
back pitch (key),
and press .

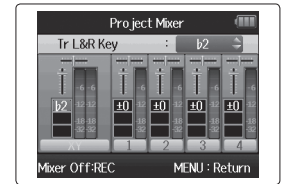
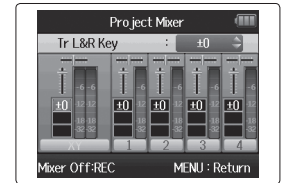

NOTE

This can be set between $\flat 6$ and $\sharp 6$.

Playback will occur with the changed pitch.



HINT

This pitch setting is saved separately for each project.

Mixing WAV format only

You can use the Project Mixer to adjust the balance of the playback tracks.

1. Press 

2. Use  to select "PROJECT MENU", and press .





3. Use  to select "Project Mixer", and press .



4. Change parameters as desired.

■ Mixing controls

Move cursor/change value: Move  up/down

Select parameter to change: Press .

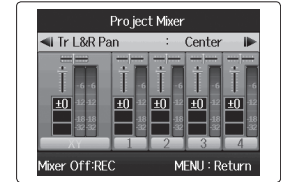

Parameter	Setting range	Explanation
Volume	Mute, -48.0 - +12dB (in 0.5dB increments)	Adjusts track volume
Panning	L100 - CENTER - R100	Adjusts left-right position of sound.
Pitch (key)	b6 - #6	Adjusts playback pitch without changing playback speed.

5. Press  to listen to the project without mixer adjustments.

Pressing this button turns the mixer settings on and off.

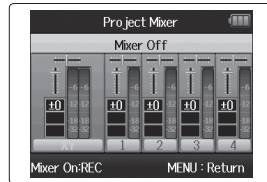

**NOTE**

- Mix settings are saved with each project separately and applied during playback.
- Use the Monitor Mixer to adjust the balance when monitoring inputs. (→ P.80)



Checking project information

You can check information about the selected project.

1. Press .

2. Use  to select
“PROJECT MENU”,
and press .



3. Use  to select
“Information”,
and press  to view
information about the project.



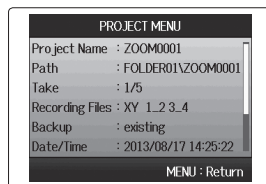

Use  to scroll down
to see information hidden
below the bottom of the
screen.





Checking track marks

A list of marks in the recorded project can be shown.

1. Press .

2. Use  to select
“PROJECT MENU”,
and press .



3. Use  to select
“Mark List”,
and press  to open
the mark list.

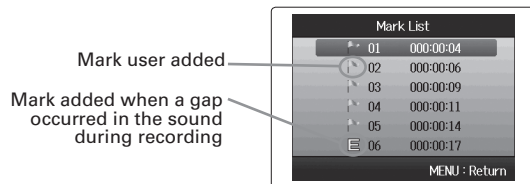

Changing project names



1. Press .

2. Use  to select
“PROJECT MENU”,
and press .



3. Use  to
select “Edit”,
and press .



4. Use  to
select “Rename”,
and press .

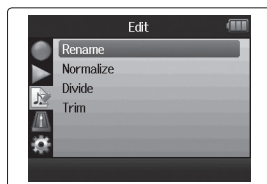

5. Change the name.

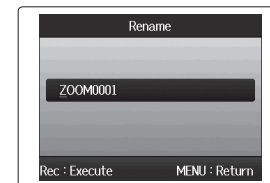

■ Controls when changing names

Move cursor/change character: Move  up/down

Select character/confirm change: Press .

6. Press  to complete the setting.

NOTE

- The following characters can be used in project names.
(space) !#\$% &'()+,-0123456789;=@ABCDEFGHIJKLM-
NOPQRSTUVWXYZ[]^_`abcdefghijklmnopqrstuvwxy{ }~
- A project name cannot be only spaces.

Mixing down a project



WAV format only

You can mix down a project that has been recorded using WAV format into a stereo file (WAV or MP3).



1. Press .

2. Use  to select "PROJECT MENU", and press .





3. Use  to select "Mixdown", and press .



4. When mixing down a project you can change the formats by using  to select "Select Format", and press .



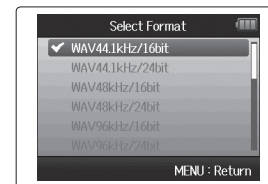

5. Use  to select the format, and press .



NOTE

You can only select WAV formats that have the same sampling frequency and bit rate as the selected project

6. Use  to select "Execute", and press  to start the mixdown.

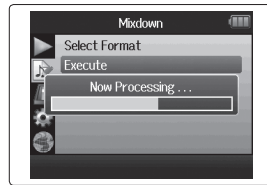

NOTE



- The mixdown file will be created in the same folder.
- If the SD card does not have enough open capacity, the recorder will return to the Mixdown screen.
- The file created by the mixdown will be named after the original project with a three digit number added to the end, as in "ZOOM0001_ST001". If you mix down the same project again, this number will increase by one.
- During mixdown, the volume, pan and track status (button) settings made using the project mixer (→ P.46), as well as the playback speed (→ P.41), will affect the sound of the mixdown.

Normalizing tracks



WAV format only

If the volume of a project recorded using WAV format is too low, you can increase the overall level of the file.



1. Press .

2. Use  to select
"PROJECT MENU",
and press .



3. Use  to select "Edit",
and press .



4. Use  to
select "Normalize",
and press .

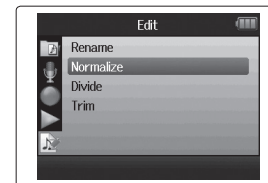

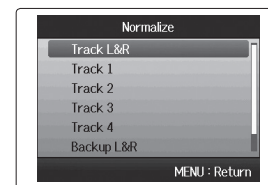

5. Use  to select the
track that you want to
normalize.



NOTE

- You cannot select a track that has no recorded file.
- If you select "All", all tracks that have files will be normalized.

6. Use  to select "Yes",
and press  to start
normalization.

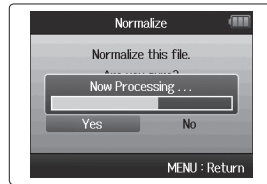
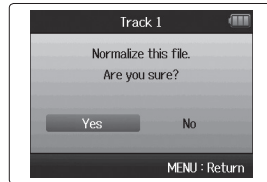

**NOTE**

When normalized, the level of the entire file will be increased by the same amount so that the peak level is 0 dB



Dividing projects

You can divide a project into two new projects at any point.



1. Press .

2. Use  to select "PROJECT MENU", and press .



3. Use  to select "Edit", and press .



4. Use  to select "Divide", and press .

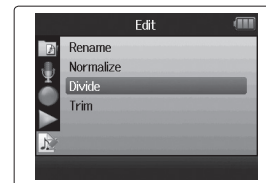

5. Set the division point.

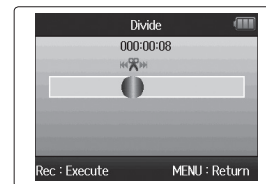







■ Controls when dividing

Move point: Use  and .

PLAY/pause: Press .

Confirm point: Press .

6. Use     to select "Yes",
and press  .

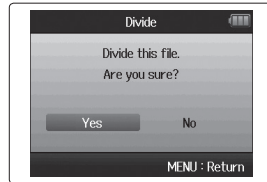
**NOTE**

- After dividing a project, the part before the division point will be given the same name as the original project with "A" added to the end. The part after the point will have "B" added to the end of its name.
- If you have made additional recordings and have multiple takes, the current take will be divided. All other takes will be saved with the original project.
- The original take is deleted.

Trimming project beginnings and ends

You can delete (trim) unnecessary beginnings and endings of recorded projects. To do so, you will set the beginning and ending points of the part to be kept.

1. Press .

2. Use  to select "PROJECT MENU", and press .



3. Use  to select "Edit", and press .



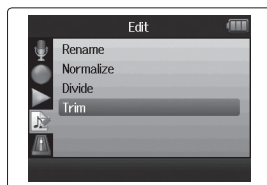

4. Use  to select "Trim", and press .



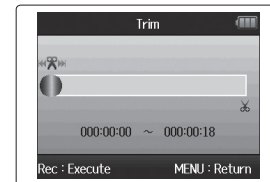

5. Use  to select the starting point icon.

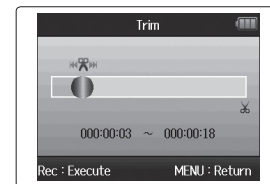

6. Use  and  to find the starting point.



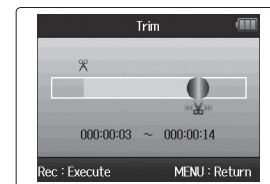

You can also press  to search while playing back.

7. Use  to select the ending point icon. Then, set the ending point in the same manner.



8. Press .

9. Use  to select "Yes",
and press  to trim the
project.



**NOTE**

If you have made additional recordings and the project has multiple takes, the current take will be trimmed.



Deleting one project

You can delete unneeded projects.



1. Press .

2. Use  to select
"PROJECT MENU",
and press .





3. Use  to
select "Trash",
and press .

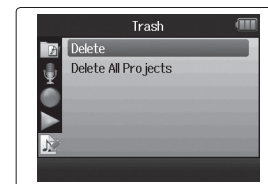

4. Use  to
select "Delete",
and press .



5. Use  to
select "Yes",
and press .

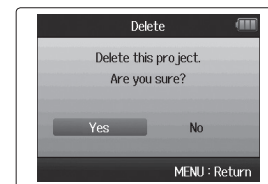



NOTE

Deleting projects cannot be undone.



Deleting all projects in a folder

You can delete all the projects in one folder at the same time.

1. Press .

2. Use  to select
"PROJECT MENU",
and press .





3. Use  to
select "Trash",
and press .



4. Use  to select
"Delete All Projects",
and press .



5. Use  to
select "Yes",
and press .

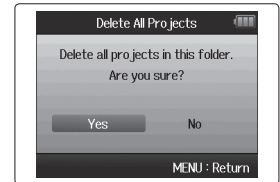



NOTE

Deleting projects cannot be undone.



Rebuilding a project

If a project is missing necessary files or is damaged, you can try rebuilding it.



1. Press .

2. Use  to select
"PROJECT MENU",
and press .



3. Use  to
select "Rebuild",
and press .



4. Use  to
select "Yes", and
press  to rebuild the
project.

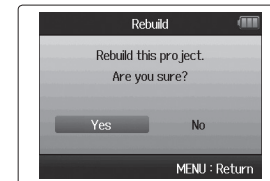



HINT

A project will not play back if, for example, you accidentally disconnect the adapter while recording or use a computer to delete a setting file that is necessary for the project. In such cases, rebuilding the project might repair it so it can be used again.



Recording a project voice memo

You can add a voice memo to a project.

1. Press .

2. Use  to select
“PROJECT MENU”,
and press .



3. Use  to select
“Voice Memo”,
and press .



4. Record the memo.

Start recording: Press .

Stop recording: Press .

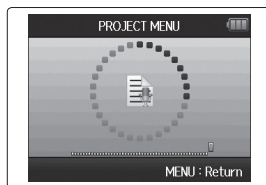

5. Play the memo.

Start playback: Press .

Stop playback: Press .

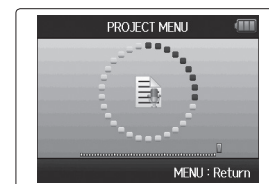



HINT

- Each time you press , the voice memo is overwritten.
- Voice memos are recorded using the stereo mic connected to the L/R input. It cannot be recorded using Inputs 1–4.
- The file name of the voice memo will be in the format of “ZOOM0001_VM”.
- The voice memo file format is 128kbps MP3.



Playing backup files WAV format only

If you have made a backup recording, you can play the backup file instead of the normal file.



1. Press .

2. Use  to select
"PROJECT MENU",
and press .



3. Use  to
select "Backup File",
and press .



4. Use  to
select "On",
and press .

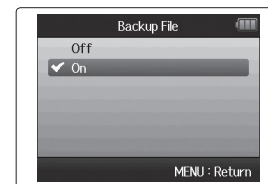



In this state, when you press , the backup file
will play back instead of the normal file for track L/R.

Data exchange with computers (card reader)

By connecting with a computer, you can check and copy data on the SD card.

1. Press .

2. Use  to select "USB",
and press .

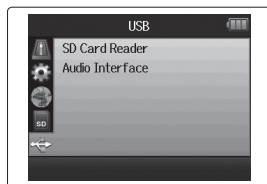

3. Use  to select
"SD Card Reader",
and press .

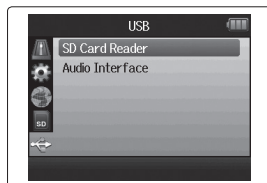

4. Connect the **H6** to the computer using a USB cable.

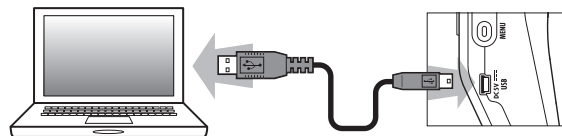

NOTE

- If you want to power the unit using the computer's USB bus, connect the cable while the **H6** power is off, and then turn it on.
- The following operating systems are supported.
 - Windows XP or later
 - Mac OS X 10.6 or later

5. Follow the procedures for your computer when you want to disconnect.

Windows:

Use "Safely Remove Hardware" to select the **H6**.

Macintosh:

Drag-and-drop the **H6** icon into the trash.

NOTE

- Always follow these procedures before disconnecting the USB cable.

-
6. Disconnect the cable from the computer and the **H6**, and then press .



Using as an audio interface

You can send signals input through the **H6** directly to a computer or iPad as well as output signals from that device through the **H6**.

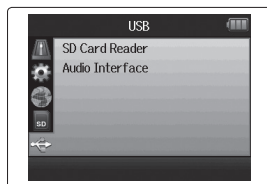

1. Press 

2. Use  to select "USB",
and press .

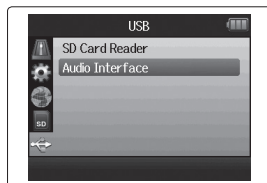

3. Use  to select
"Audio Interface",
and press .





4. Use  to select "Stereo
Mix" or "Multi track",
and press .



NOTE

- Set to "Stereo Mix"; it is a 2 in/2 out interface. Set to "Multi Track" it is a 6 in/2 out interface.
- With an iPad, use Stereo Mix mode. It will not work with MultiTrack mode.
- When using Stereo Mix mode you can use the recorder's mixer to mix all track inputs to stereo. (→ P.72)
- When using Windows, a driver is necessary to use Multi Track mode. You can download this driver from the ZOOM website (www.zoom.co.jp).

5. Use  to select
"PC/Mac", "PC/MAC using
battery power" or "iPad
using battery power",
and press .

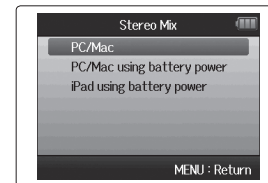

HINT

- When using a computer that does not provide enough power through its USB bus and when using phantom power, select "PC/Mac using battery power".
- The "iPad using battery power" setting uses the batteries in the recorder.

- 6.** Connect the **H6** to the computer or iPad using a USB cable.

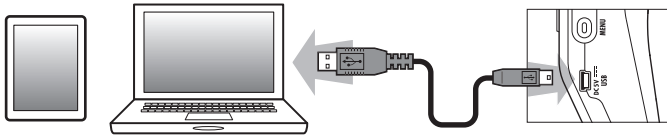

NOTE



An iPad Camera Connection Kit is necessary to connect an iPad.

HINT

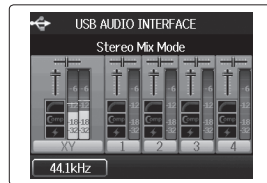

See "Audio interface settings." (→ P.70)

- 7.** Press  to disconnect.



- 8.** Use  to select "EXIT", and press .



- 9.** Use  to select "Yes", and press .

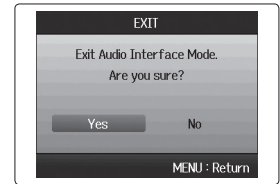

- 10.** Disconnect the cable from the computer or iPad and the **H6**, and then press .

Audio interface settings



When using the **H6** as an audio interface, you can make the following settings. Refer to each section for details.

Input settings	Low cut filter (→ P.78)
	Compressor/limiter (→ P.79)
	Direct monitoring (→ P.70)
	MS-RAW monitoring (→ P.82)
	Phantom power (→ P.87)
	Plug-in power (→ P.88)
	Loop Back function (→ P.71)
Mixer (→ P.72)	
VU meters (→ P.89)	
Tool	Tuner (→ P.74)



Making direct monitoring settings

Sound that is input to the **H6** can be output directly before it passes through the connected computer or iPad. This enables monitoring without latency.

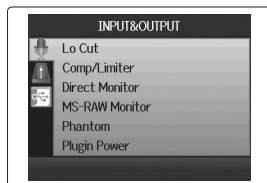

1. Press .

2. Use  to select "INPUT&OUTPUT", and press .

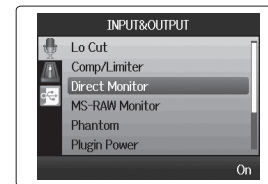

3. Use  to select "Direct Monitor", and press .



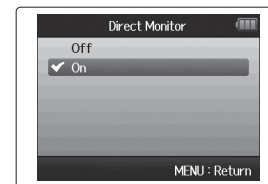

4. Use  to select "On", and press .





Using Loop Back (in stereo mix mode)

When in stereo mix mode, you can mix the sound from the computer or iPad with the sound input in the **H6** and send it back to the computer or iPad again (loop back). This can be used, for example to add narration to a musical backing track playing on the computer and then record using software on the computer or stream it live via the Internet.

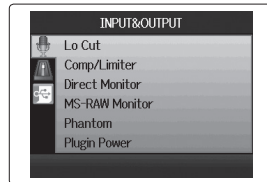

1. Press .

2. Use  to select "INPUT&OUTPUT", and press .

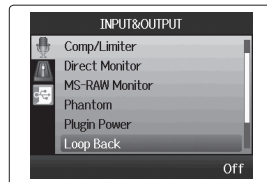

3. Use  to select "Loop Back", and press .



4. Use  to select "On", and press .

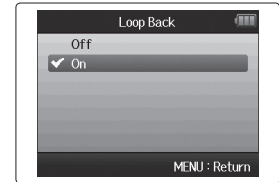



Audio interface settings (continued)



Mixing the inputs

You can adjust the mix of the inputs. The results of this mix are input to a computer or iPad. When in stereo mix mode, the resulting stereo mix is sent.

1. Press .

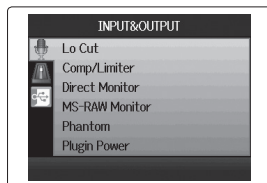
2. Use  to select "INPUT&OUTPUT", and press .



3. Use  to select "Mixer", and press .

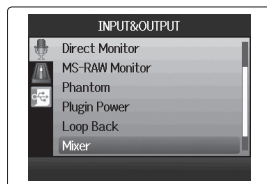

4. Change the parameter settings as desired.

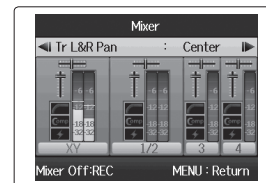

■ Mixing controls

Move cursor/change value: Move  up/down

Select parameter to change: Press .

5. Press  to listen to the project without mixer adjustments.

Pressing this button turns the mixer settings on and off.

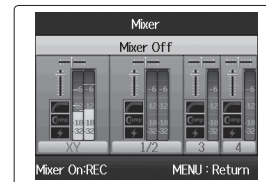

HINT

The same mix settings are saved and used for both stereo mix and multi track modes.



Using the tuner

The input signal can be used to tune an instrument.

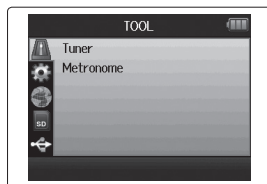

1. Press .

2. Use  to select "TOOL",
and press .

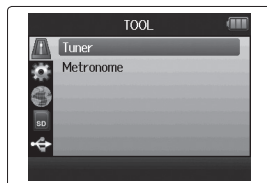

3. Use  to select "Tuner",
and press .



4. Use  to select the
tuning type,
and press .

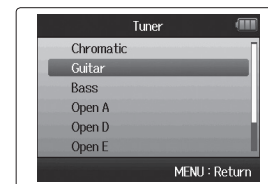

5. Use  to change the
standard pitch.

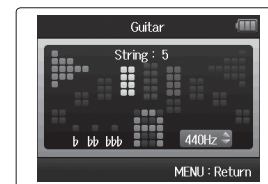

HINT

The standard pitch can be set in a range between 435Hz–445Hz.

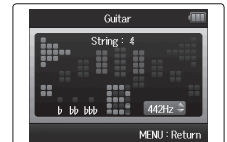

6. For all tuner types except chromatic, you can use

◀◀ and ▶▶ to change the pitch (drop tuning).

HINT

You can drop the tuning by up to three semitones.

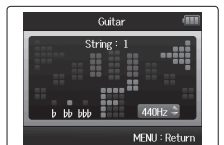

7. Press a track button to select the input to use.

8. Use the tuner according to the type as follows

■ Chromatic tuner

The input is detected automatically and the name of the nearest note and the pitch inaccuracy are shown.

Center lights when pitch accurate

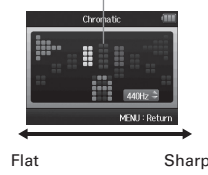

■ Guitar/bass tuner

The number of the string you are tuning is automatically detected, allowing you to tune them one at a time.

Center lights when pitch accurate

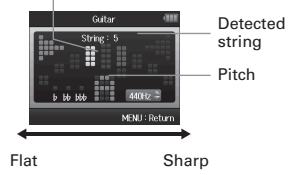



Tuner type	String number/note name						
	1	2	3	4	5	6	7
Guitar	E	B	G	D	A	E	B
Bass	G	D	A	E	B		
Open A	E	C#	A	E	A	E	
Open D	D	A	F#	D	A	D	
Open E	E	B	G#	E	B	E	
Open G	D	B	G	D	G	D	
DADGAD	D	A	G	D	A	D	



Using the metronome

Use the metronome to count in before recording or as a click track.

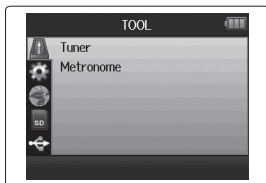

1. Press .

2. Use  to select "TOOL",
and press .



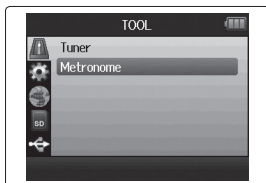

3. Use  to select "Metronome",
and press .

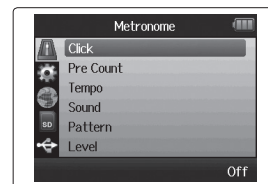

4. Use  to select
a menu item,
and press .





■ Select "Click"

Use  to set when the
metronome is active, and
press .



■ Select "Pre Count" (→ P.32)

■ Select "Tempo"

Use  to set the speed,
and press .



■ Select “Sound”

Use  to set the sound,

and press .

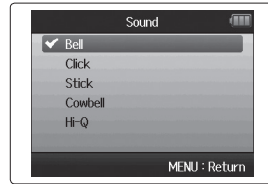



■ Select “Pattern”

Use  to set the pattern,

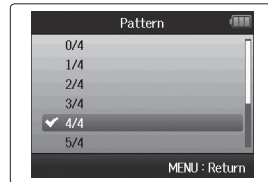
and press .



■ Select “Level”



Use  to set the metronome volume, and press .





Reducing noise (low cut filter)

Use the low-cut filter to reduce wind noise and vocal pops, for example.

1. Press .

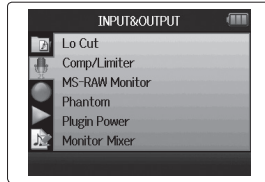
2. Use  to select
"INPUT&OUTPUT",
and press .





3. Use  to select
"Lo Cut",
and press .

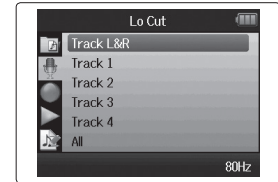

4. Use  to select the
track you want to apply
the low cut filter to,
and press .



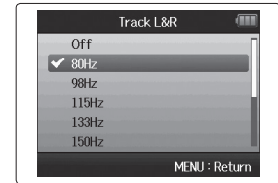

5. Use  to select the
cutoff frequency of the
low cut filter,
and press .





Using the input compressor/limiter

Use the compressor/limiter to raise low-level input signals and lower high-level input signals.

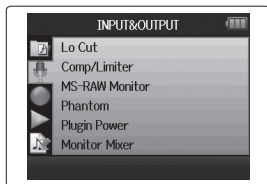

1. Press .

2. Use  to select "INPUT&OUTPUT", and press .



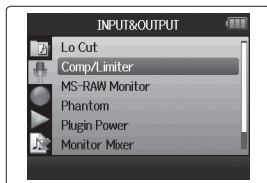

3. Use  to select "Comp/Limiter", and press .

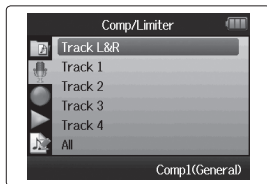

4. Use  to select the track you want to affect, and press .



5. Use  to select the type of compressor/limiter, and press .

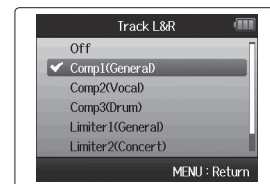



Setting	Explanation	
Off	Compressor/limiter OFF	
Comp1 (General)	Standard compressor	Compressors reduce high levels and raise low levels.
Comp2 (Vocal)	Compressor for vocals	
Comp3 (Drum)	Compressor for drums and percussion	
Limiter1 (General)	Standard limiter	Limiters reduce the level when input signals exceed a set level.
Limiter2 (Concert)	Limiter for live performances	
Limiter3 (Studio)	Limiter for studio recording	

Adjusting the input signal monitoring mix

You can adjust the level and panning of each input signal for the monitoring mix.

1. Press .

2. Use  to select
"INPUT&OUTPUT",
and press .

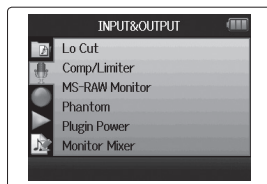



3. Use  to select
"Monitor Mixer",
and press .



4. Change parameters as
desired.

■ Mixing controls

Move cursor/change value: Move  up/down

Select parameter to change: Press .

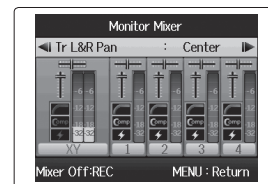

Parameter	Setting range	Explanation
Volume	Mute, -48.0 – +12dB (in 0.5dB increments)	Adjusts track volume
Panning	L100 – CENTER – R100	Adjusts left-right position of sound.

NOTE

- The use of volume and panning settings only affect the monitoring signal. They do not affect the recorded data.
- Use the Project Mixer to adjust the balance during playback. (→ P.46)

5. Press  to listen to the project without mixer adjustments.

Pressing this button turns the mixer settings on and off.

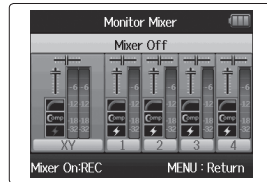

**NOTE**

These mix settings are saved with each recorded project separately. Mix settings can also be applied during playback. (→ P.46)



Monitoring MS-RAW signals MS-RAW mode only

When recording in MS-RAW mode, you can monitor the mid mic input through the left channel and the side mic input through the right channel.

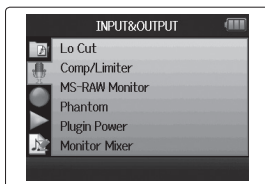

1. Press .

2. Use  to select
“INPUT&OUTPUT”,
and press .

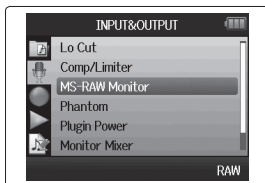

3. Use  to select
“MS-RAW Monitor”,
and press .



4. Use  to
select “RAW”,
and press .

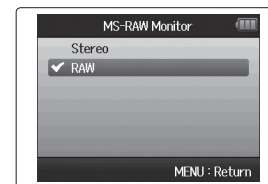

NOTE

Select “Stereo” if you want to monitor with an ordinary stereo mix.

Setting the recording format

Set the format according to the desired audio quality and file size.

1. Press .

2. Use  to select

“REC”,

and press .



3. Use  to select

“Rec Format”,

and press .



4. Use  to select the

desired format,

and press .

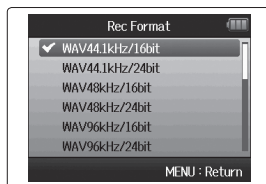

NOTE



- Use the WAV format for recording high-quality audio.
- The MP3 format reduces file size through compression, which also reduces the audio quality. Use this format if you need to conserve space on the SD card to store many recordings, for example.
- When recording in MP3 format, a single stereo MP3 file will be created regardless of the number of tracks selected. You can use the monitoring mixer to adjust the balance of all the tracks in the stereo mix. (→ P.80)

	Audio quality	File size
WAV96kHz/24bit	↑ High	↓ Large
WAV96kHz/16bit		
WAV48kHz/24bit		
WAV44.1kHz/24bit		
WAV48kHz/16bit		
WAV44.1kHz/16bit		
MP3 320kbps		
MP3 256kbps		
MP3 224kbps		
MP3 192kbps		
MP3 160kbps		
MP3 128kbps		
MP3 112kbps		
MP3 96kbps		
MP3 80kbps		
MP3 64kbps		
MP3 56kbps		
MP3 48kbps	↓ Low	↑ Small



Changing automatic recording settings

You can set the input levels that cause automatic recording to start and stop.

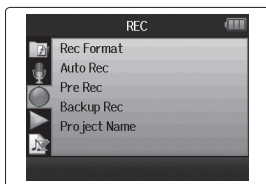

1. Press .

2. Use  to select
"REC",
and press .





3. Use  to
select "Auto Rec",
and press .





4. To set the recording start-
ing level, use  to
select "Set Start & Stop
Level", and press .



5. Use  to
select "Start Level",
and press .



6. Use  to set the
start level,
and press .









Recording will start
automatically when the input
level exceeds the set level.







NOTE

In step 5, you can also choose "Stop Level".

Enabling automatic stopping

1. To set the automatic stopping time, use    to select "Auto Stop", and press   .



2. Use    to set the stop time, and press   .





3. Set the stop level in the same manner as the start level. (→ P.84)

When the input level goes below the set level, recording will stop automatically after the amount of time set in step 2 above.

Setting how projects are named

You can change the type of name that is automatically given to a project.



1. Press .

2. Use  to select
"REC", and
press .

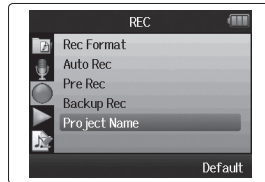

3. Use  to select
"Project Name",
and press .



4. Use  to select
the type,
and press .

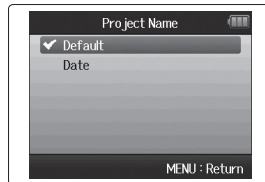



NOTE

- Project names are created in the following formats.
 - Default: ZOOM0001-ZOOM9999
 - Date: YYMMDD-HHMMSS (Example: 130331-123016)
- The "Date" format uses the recording starting time.



Changing the phantom power setting

Inputs 1–4 can provide phantom power of +12V, +24V or +48V.

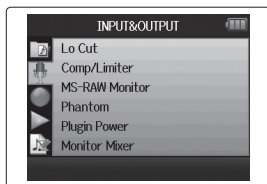

1. Press .

2. Use  to select
“INPUT&OUTPUT”,
and press .



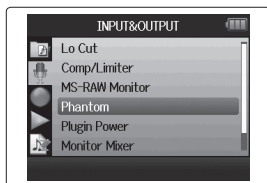

3. Use  to select
“Phantom”,
and press .



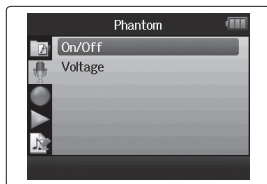

4. Use  to select
a menu item,
and press .



■ Select “ON/OFF”

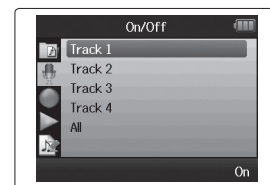

Use  to select the
input you want to set,
and press .

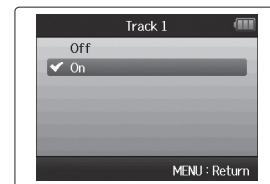

Use  to select “On”,
and press .



■ Select “Voltage”

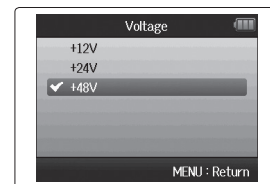

Use  to select
the desired voltage,
and press .





Using plug-in power

When using a mic that uses plug-in power, make the following setting before connecting it to the **MIC/LINE** input jack of the **XY mic**.

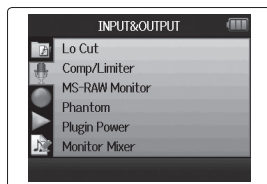

1. Press .

2. Use  to select
“INPUT&OUTPUT”,
and press .

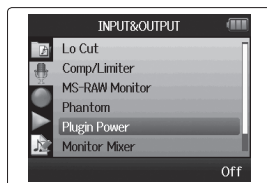

3. Use  to select
“Plugin Power”,
and press .



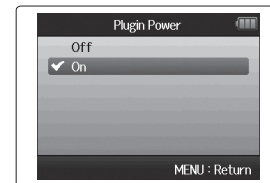

4. Use  to
select “On”,
and press .





Using VU meters to check input levels

The virtual VU meters can be used to check input levels.

1. Press .

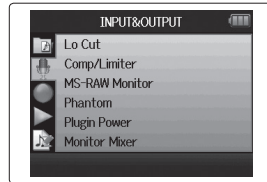
2. Use  to select
“INPUT&OUTPUT”,
and press .



3. Use  to select
“VU Meter”,
and press .

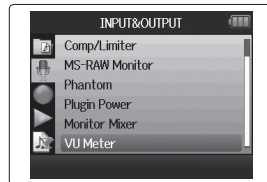

4. Use  to adjust input
levels and check them
here.

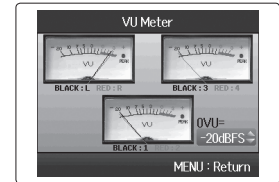

5. Use  to adjust the reference that is used for 0VU.



HINT

The reference level can be set between -20dBFS and -10dBFS . The dBFS unit represents the loudness of the signal in dB with 0dBFS being the maximum recordable value for the digital data.

Setting the display to save power

You can set the display backlight to dim or turn off when no operation is conducted for 30 seconds in order to save power.

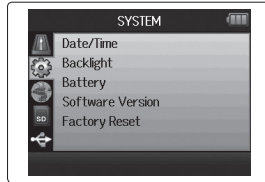

1. Press .

2. Use  to select “SYSTEM”, and press .



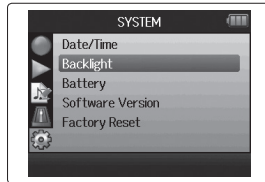

3. Use  to select “Backlight”, and press .



4. Use  to select “Power Saving”, and press .



5. Use  to select the desired setting, and press .





NOTE

When using an AC adapter, this setting has no effect.

Adjusting the display brightness

1. Press .

2. Use  to select
"SYSTEM",
and press .

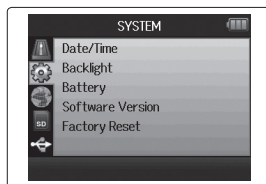



3. Use  to select
"Backlight",
and press .

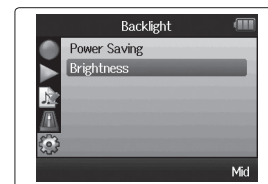

4. Use  to select
"Brightness",
and press .



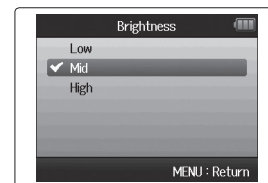

5. Use  to select
the desired brightness,
and press .





Checking the firmware versions

You can check the software versions used by the **H6** .

1. Press .

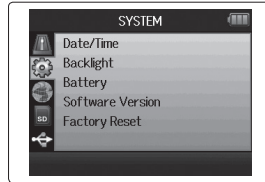
2. Use  to select
"SYSTEM",
and press .



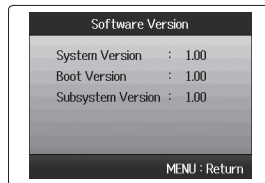
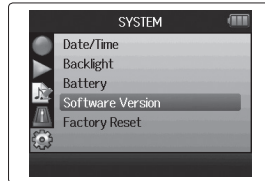

3. Use  to select
"Software Version",
and press  to open a
screen where you can
view the firmware
versions.





Restoring the default settings

You can restore the unit to its factory default settings.

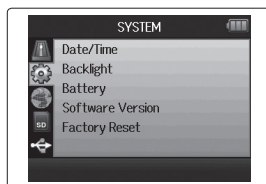

1. Press .

2. Use  to select
"SYSTEM",
and press .

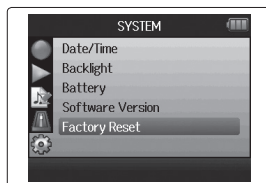

3. Use  to select
"Factory Reset",
and press .



4. Use  to
select "Yes",
and press  to restore
the default settings.

The power will automatically
turn off.





NOTE



Input level settings are not reset.

Checking SD card open space

1. Press .

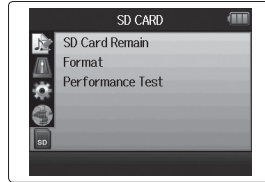
2. Use  to select
“SD CARD”,
and press .



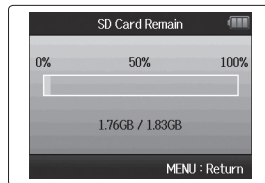
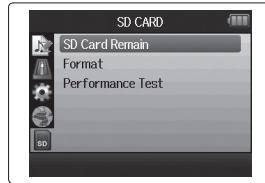

3. Use  to select
“SD Card Remain”,
and press  to see the
amount of remaining open
space on the card.





Formatting SD cards

SD cards must be formatted by the **H6** for use with it.

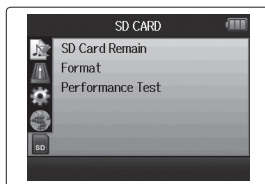

1. Press .

2. Use  to select
“SD CARD”,
and press .

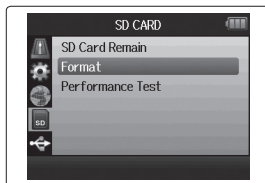

3. Use  to select
“Format”,
and press .



4. Use  to
select “Yes”
and press  to format
the SD card.

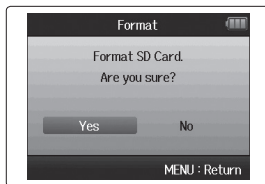



NOTE

- If you use an SD card that has been formatted by a computer or that you have purchased, you must format it using the **H6** before it can be used with the unit.
- Be aware that all data previously saved on the SD card will be deleted when it is formatted.



Testing SD card performance

You can test SD cards to confirm that they can be used with the **H6**.

1. Press .

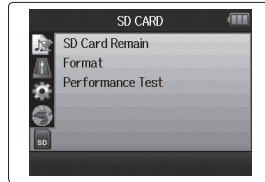
2. Use  to select "SD CARD", and press .



3. Use  to select "Performance Test", and press .

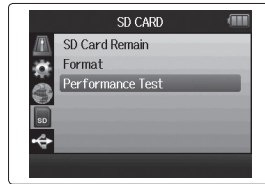

4. Press  to start the performance test.

Test progress
Card access rate

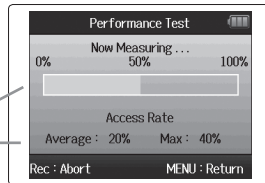

5. When the test completes, the result will be shown.

If the MAX access rate is 100%, the result will be "NG" (no good).

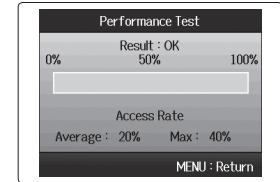

6. To cancel testing, press .

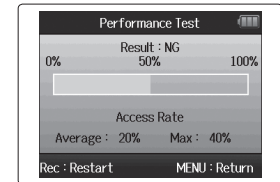

NOTE

Even if an SD card is evaluated as "OK" by the performance test, this does not guarantee that write errors will never occur. Please use this test just as a guide.



Updating the firmware

The **H6** can be updated to the latest firmware versions.

1. Copy the version update file to the root directory of the SD card.

2. Insert the SD card into the **H6**.

Then, turn the power on while pressing .

3. Use  to select "Yes", and press  to update the firmware.

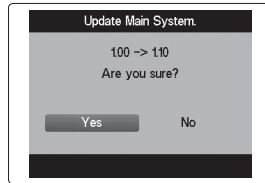

4. After the firmware update completes, turn the power off.

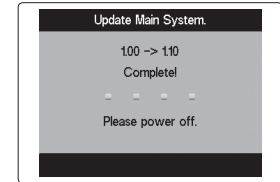







NOTE

Updating the firmware is not possible when the remaining battery power is too low. If this is the case, install new batteries or use an AC adapter (sold separately).

Using SD cards from older H series recorders

An SD card that has been used in an older ZOOM H series recorder can be read and used by the **H6**. The files will be moved on the card so that the **H6** can use them.

1. Insert the SD card, and then turn the power on.

2. Use    to select "Yes", and press    to move the files.

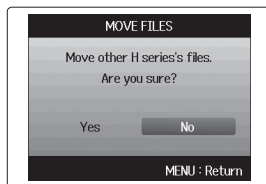

NOTE

- If a file with the same name already exists in a destination location, movement will not be possible until the file name is changed.
- After files are moved, they will not be recognized by older H series recorders.

Using a remote control (sold separately)

By using a remote control (sold separately), you can operate the **H6** from a distance.

- Connect the remote control to the **H6 REMOTE** jack.

The buttons on the remote control correspond to the buttons on the **H6** main unit.

HINT

The remote control buttons function even when the **H6** hold function is active.

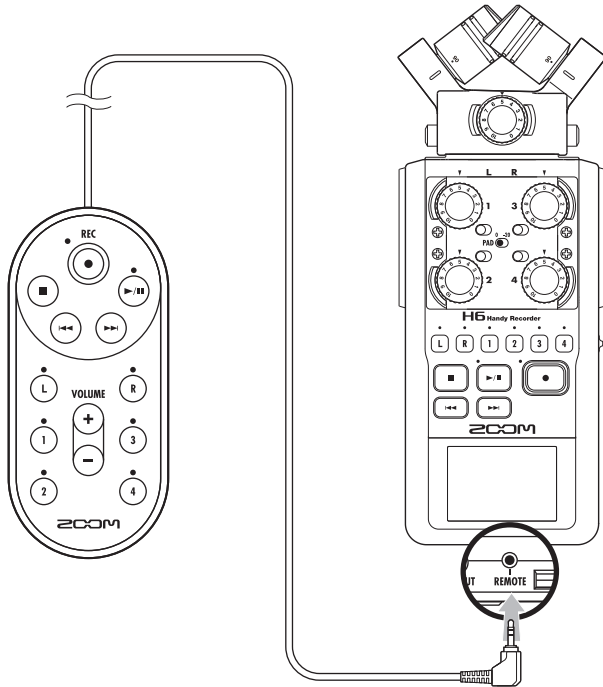

Troubleshooting

If you think that the **H6** is not operating properly, please check the following first.

Recording/playback trouble

◆ There is no sound or output is very quiet

- Check the connections to your monitoring system and its volume setting.
- Confirm that the volume of the **H6** is not too low.

◆ The recorded sound cannot be heard or is very quiet

- If you are using the included XY or MS mic, confirm that it is oriented correctly.
- Check the input level settings. (→ P.24)
- If a CD player or other device is connected to an input jack, raise the output level of that device.

◆ Recording is not possible

- Confirm that the SD card has open space. (→ P.94)
- If “Hold is On” appears on the display, the hold function is enabled. Disable the hold function. (→ P.20).

Other trouble

◆ The **H6** is not recognized by a computer when connected by USB

- Check that the OS of the computer is compatible. (→ P.66).
- A USB operation mode must be selected on the **H6** to allow a computer to recognize it. (→ P.66).

Specifications

Recording media		16MB–2GB SD cards, 4GB–32GB SDHC cards, 64GB–128GB SDXC cards	
Inputs	L/R inputs	XY mic (XYH-6)	
		Mic type	Directional
		Sensitivity	–41 dB, 1 kHz at 1 Pa
		Input gain	–∞ to 46.5 dB
		Maximum sound pressure input	136 dB SPL
		MIC/LINE IN stereo mini jack	Input gain: –∞ to 46.5 dB Input impedance: 2 kΩ Plug-in power: 2.5V supported
	MS mic (MSH-6)	Mic types	Directional and bidirectional
		Sensitivity	–37 dB, 1 kHz at 1 Pa (directional) , –39 dB, 1 kHz at 1 Pa (bidirectional)
		Input gain	–∞ to 42.5 dB
		Maximum sound pressure input	120 dB SPL (directional), 122 dB SPL (bidirectional)
		Backup input	Set input gain –12 dB
		Connectors	XLR/TRS combo jacks (XLR: 2 hot, TRS: TIP hot)
	INPUTS 1 – 4	Input gain (PAD OFF)	–∞ to 55.5 dB
		Input gain (PAD ON)	–∞ to 35.5 dB
Input impedance		1.8kΩ or more	
Maximum allowable input level		+22 dBu (PAD ON)	
Phantom power		+12/+24/+48V (can be turned ON/OFF independently for INPUTS 1–4)	
Equivalent input noise (EIN)		–120 dBu or less	
Outputs	Output jack	LINE OUT stereo mini jack (rated output level –10 dBu when output load impedance is 10 kΩ or more)	
	PHONE OUT stereo mini jack (20 W + 20 W into 32Ω load)		
	Built-in speaker	400 mW/8 Ω mono speaker	
Recording formats	WAV setting		
	Supported formats	44.1/48/96kHz, 16/24-bit, mono/stereo, BWF format	
	Maximum simultaneous recording tracks	8 tracks (6 tracks + backup stereo recording)	
	MP3 setting		
Supported formats	48–320 kbps		
Maximum simultaneous recording tracks	2 tracks		
Recording time	With 2GB card		
	3:08:00 (44.1kHz/16-bit WAV)		
	34:43:00 (128kbps MP3)		
Display	2" full-color LCD (320 x 240)		

USB	Mass storage class operation	
	Class: USB 2.0 High Speed	
	Audio interface operation: multi track mode (Note: Use with Windows requires a driver, but Macintosh does not)	
	Class: USB 2.0 High Speed	
	Specifications: 6 in/2 out, 44.1/48kHz/96kHz sampling rate, 16/24-bit bit rate	
	Audio interface operation: stereo mode	
	Class: USB 2.0 Full Speed	
Approximate continuous recording times when using battery power (in hours and minutes)	Recording mode	
	XY mic, 44.1kHz/16-bit (stereo x 1)	21h00m
	XY mic and Inputs 1, 2, 3 and 4 used, 96kHz/24-bit (stereo x 3)	9h45m
	Note: The above times are estimates.	
	Note: Approximate continuous recording times when using battery power were calculated using our own testing method. They may differ greatly depending on operating conditions.	
Power	Operating using 4 AA batteries	
	AC adapter: DC5V 1A AD-17 (sold separately)	
	USB bus power	
Dimensions	Main unit: 77.8 mm (W) x 152.8 mm (D) x 47.8 mm (H), 280 g	
	XYH-6: 78.9 mm (W) x 60.2 mm (D) x 45.2 mm (H), 130 g	
	MSH-6: 58.0 mm (W) x 67.6 mm (D) x 42.1 mm (H) 85 g	
Included accessories	Operation manual	
	SD card	
	4 AA batteries	
	Cubase LE DVD-ROM	
	Main unit case	
	Wind screen (sponge)	
	USB cable	
	XYH-6	
MSH-6		

FCC regulation warning (for U.S.A.)

This equipment has been tested and found to comply with the limits for a Class B digital device, pursuant to Part 15 of the FCC Rules. These limits are designed to provide reasonable protection against harmful interference in a residential installation. This equipment generates, uses, and can radiate radio frequency energy and, if not installed and used in accordance with the instructions, may cause harmful interference to radio communications. However, there is no guarantee that interference will not occur in a particular installation. If this equipment does cause harmful interference to radio or television reception, which can be determined by turning the equipment off and on, the user is encouraged to try to correct the interference by one or more of the following measures:

- Reorient or relocate the receiving antenna.
- Increase the separation between the equipment and receiver.
- Connect the equipment to an outlet on a circuit different from that to which the receiver is connected.
- Consult the dealer or an experienced radio/TV technician for help.

For EU Countries



Declaration of Conformity:

This product complies with the requirements of EMC Directive 2004/108/EC and Low Voltage Directive 2006/95/EC and ErP Directive 2009/125/EC and RoHS Directive 2011/65/EU



Disposal of Old Electrical & Electronic Equipment

(Applicable in European countries with separate collection systems)

This symbol on the product or on its packaging indicates that this product shall not be treated as household waste. Instead it shall be handed over to the applicable collection point for the recycling of electrical and electronic equipment. By ensuring this product is disposed of correctly, you will help prevent potential negative consequences for the environment and human health, which could otherwise be caused by inappropriate waste handling of this product. The recycling of materials will help to conserve natural resources. For more detailed information about recycling of this product, please contact your local city office, your household waste disposal service or the shop where you purchased the product.

ZOOM

ZOOM CORPORATION

4-4-3 Surugadai, Kanda, Chiyoda-ku, Tokyo 101-0062 Japan

<http://www.zoom.co.jp>

ZOOM[®]

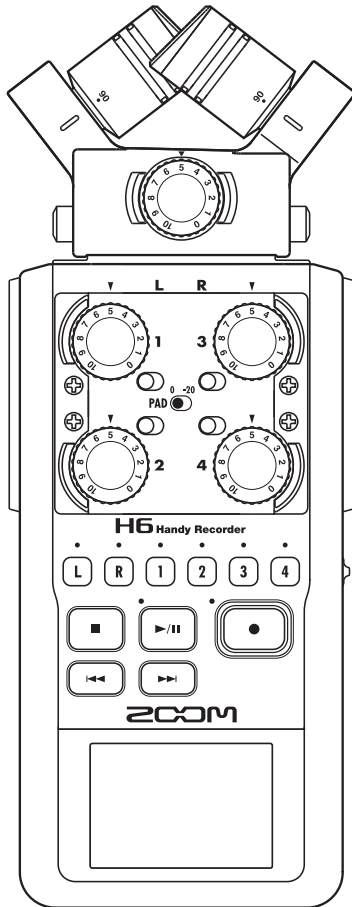

H6 Handy Recorder

Version 2.0 Supplementary Manual





© 2014 ZOOM CORPORATION

Reproduction of this manual in whole or in part
by any means without permission is prohibited.





Testing SD card performance

You can test an SD card to confirm that it can be used with the **H6**.

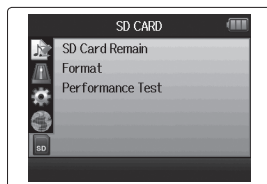
1. Press 

2. Use   to select "SD CARD" and press   



3. Use   to select "Performance Test" and press   

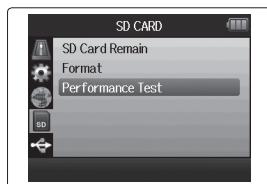

4. The test starts

The test takes about 30 seconds.

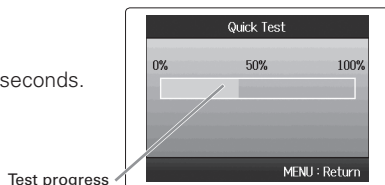





NOTE

Press  to cancel the test.

5. The quick test completes

The screen shows the test results and an option to conduct a full test along with the time required for it.

6. For a full test, press   to select "Yes" and press    to start it

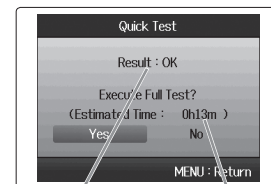

Test result
Time required for full test

The full test checks the entire writable area of the card.



NOTE

- After conducting the full test, see P96 of the **H6** operation manual for details.
- Even if the performance test result is "OK", this does not guarantee that write errors will not occur. Please consider it to be just a performance estimate.



Lowering the line output level

You can lower the output level of the LINE OUT jack. Use this when the output signal of the LINE OUT jack is input to the external mic input jack of an SLR camera or another connector with high input gain.

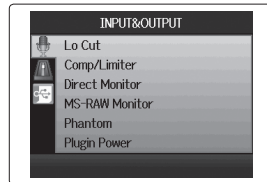

1. Press 

2. Use  to select "INPUT&OUTPUT" and press 

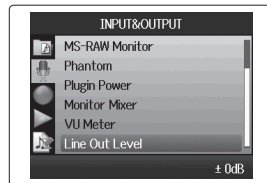

3. Use  to select "Line Out Level" and press 



4. Use  to set the output level of the LINE OUT jack and press 





NOTE

This setting does not affect the output level of the PHONE jack.



Converting MS format input signals to ordinary stereo

Signals from an MS format stereo mic input through Inputs 1/2 or Inputs 3/4 can be converted to an ordinary stereo signal.

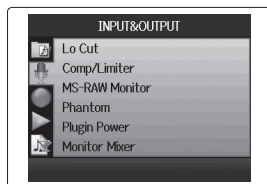

1. Press 

2. Use  to select "INPUT&OUTPUT" and press 





3. Use  to select "MS Matrix" and press 



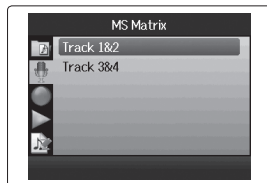

4. Use  to select the tracks to convert and press 

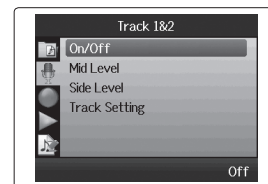

5. Use  to select an item, and press 



■ Turn "On/Off"

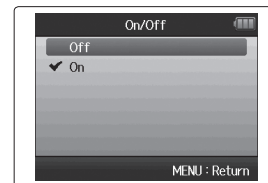

Use  to select "On" and press 



NOTE

When set to On, the selected tracks will be converted into stereo tracks.

■ Set "Mid Level"

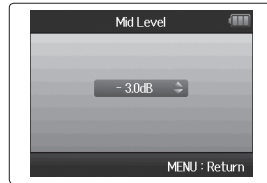

Use  to set the level of the mid mic, which captures the center sound, and press 



HINT

Mid Level can be set to mute and in a range from -48.0 to +12.0 dB.

■ Set "Side Level"



Use  to set the level of the side mic, which captures the sound to the left and right, and press 



HINT

Side Level can be set to mute and in a range from -48.0 to +12.0 dB.

■ Selecting the "Track Setting"

Use  to select Mid and Side assignments for Inputs 1/2 (or 3/4) and press 



Monitoring the input signals of specified tracks (SOLO mode)

You can monitor the input signals of specified tracks using SOLO mode.

1. Press and hold the buttons of the tracks that you want to monitor

The indicators for the selected track keys will light orange.

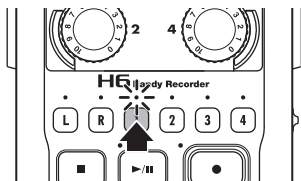

The input signals of the selected tracks will be output from the PHONE and LINE OUT jacks.

NOTE

- SOLO mode can only be used with tracks that have input signals (indicators lit red).
- To monitor L/R tracks (mic input), press and hold either the L or the R button.
- Even when monitoring in SOLO mode, the inputs of tracks that have names shown in red on the display are being recorded.

HINT

- When monitoring, press and hold another track button to add that track to the signals monitored.
- Even when monitoring in SOLO mode, the automatic recording function will operate in response to the input levels of all tracks.

2. Press the button of a track being monitored to end SOLO mode

The indicators for all tracks being input will light red, and the input signals of other tracks will also be output.

HINT



You can also exit SOLO mode by pressing [Ⓜ] to open the settings screen and then returning to the Home Screen.

Outputting tone signals when starting and stopping recording (sound marker function)



When starting and stopping recording, the **H6** can output tone signals (sound markers).

When recording audio for video with the **H6**, by inputting tone signals into the camera recording, aligning the audio with the video will be easier.



1. Press 

2. Use  to select "REC" and press 





3. Use  to select "Sound Marker" and press 

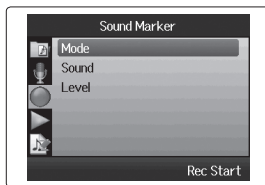

4. Use  to select a menu item and press 



■ Setting the "Mode"



Use  to select the conditions for outputting sound markers and press 



NOTE



Markers will not be output when the overdubbing or voice memo functions is in use.

■ Setting the "Sound"

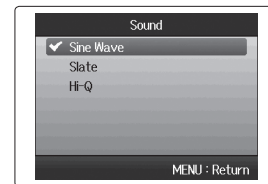
Use  to select the type of sound marker and press 



■ Setting the "Level"

Use  to set the sound marker level and press 

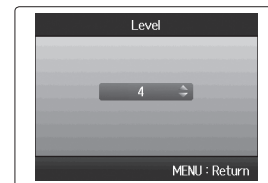

ZOOM[®]

ZOOM CORPORATION

4-4-3 Kanda-Surugadai, Chiyoda-ku, Tokyo 101-0062 Japan

<http://www.zoom.co.jp>