

YAMAHA

TONE GENERATOR

TG77



OPERATING MANUAL

FCC INFORMATION (U.S.A.)

1. IMPORTANT NOTICE: DO NOT MODIFY THIS UNIT!

This product, when installed as indicated in the instructions contained in this manual, meets FCC requirements. Modifications not expressly approved by Yamaha may void your authority, granted by the FCC, to use the product.

2. IMPORTANT: When connecting this product to accessories and/or another product use only high quality shielded cables. Cable/s supplied with this product MUST be used. Follow all installation instructions. Failure to follow instructions could void your FCC authorization to use this product in the USA.

3. NOTE: This product has been tested and found to comply with the requirements listed in FCC Regulations, Part 15 for Class "B" digital devices. Compliance with these requirements provides a reasonable level of assurance that your use of this product in a residential environment will not result in harmful interference with other electronic devices. This equipment generates/uses radio frequencies and, if not installed and used according to the instructions found in the users manual, may cause interference harmful to the operation of other electronic devices. Compliance with FCC regulations does not guarantee that interference will not occur in all installations. If this product is found to be the source of interference, which can be determined by turning the unit "OFF" and "ON", please try to eliminate the problem by using one of the following measures:

Relocate either this product or the device that is being affected by the interference.

Utilize power outlets that are on different branch (circuit breaker or fuse) circuits or install AC line filter/s.

In the case of radio or TV interference, relocate/reorient the antenna. If the antenna lead-in is 300 ohm ribbon lead, change the lead-in to co-axial type cable.

If these corrective measures do not produce satisfactory results, please contact the local retailer authorized to distribute this type of product. If you can not locate the appropriate retailer, please contact Yamaha Corporation of America, Electronic Service Division, 6600 Orangethorpe Ave, Buena Park, CA 90620

The above statements apply ONLY to those products distributed by Yamaha Corporation of America or its subsidiaries.

* This applies only to products distributed by YAMAHA CORPORATION OF AMERICA.

Litiumbatteri!

Bör endast bytas av servicepersonal.
Explosionsfara vid felaktig hantering.

VAROITUS!

Lithiumparisto, Räjähdyksvaara.
Pariston saa vaihtaa ainoastaan alan ammattimies.

ADVARSEL!

Lithiumbatteri!
Eksplosionsfare. Udskiftning må kun foretages af en sagkyndig, – og som beskrevet i servicemanualen.

IMPORTANT NOTICE FOR THE UNITED KINGDOM

Connecting the Plug and Cord

IMPORTANT: The wires in this mains lead are coloured in accordance with the following code:

BLUE : NEUTRAL
BROWN : LIVE

As the colours of the wires in the mains lead of this apparatus may not correspond with the coloured markings identifying the terminals in your plug proceed as follows:

The wire which is coloured **BLUE** must be connected to the terminal which is marked with the letter **N** or coloured **BLACK**.

The wire which is coloured **BROWN** must be connected to the terminal which is marked with the letter **L** or coloured **RED**.

* This applies only to products distributed by YAMAHA - KEMBLE MUSIC (U.K.) LTD.

CANADA

THIS DIGITAL APPARATUS DOES NOT EXCEED THE "CLASS B" LIMITS FOR RADIO NOISE EMISSIONS FROM DIGITAL APPARATUS SET OUT IN THE RADIO INTERFERENCE REGULATION OF THE CANADIAN DEPARTMENT OF COMMUNICATIONS.

LE PRESENT APPAREIL NUMERIQUE N'EMET PAS DE BRUITS RADIOELECTRIQUES DEPASSANT LES LIMITES APPLICABLES AUX APPAREILS NUMERIQUES DE LA "CLASSE B" PRESCRITES DANS LE REGLEMENT SUR LE BROUILLAGE RADIOELECTRIQUE EDICTE PAR LE MINISTRE DES COMMUNICATIONS DU CANADA.

* This applies only to products distributed by YAMAHA CANADA MUSIC LTD.

SUPPLEMENTAL MARKING INFORMATION

Yamaha Digital Musical Instrument Products will have either a label similar to the graphic shown below or a molded/stamped facsimile of the graphic on its enclosure. The explanation of these graphics appears on this page. Please observe all cautions indicated.

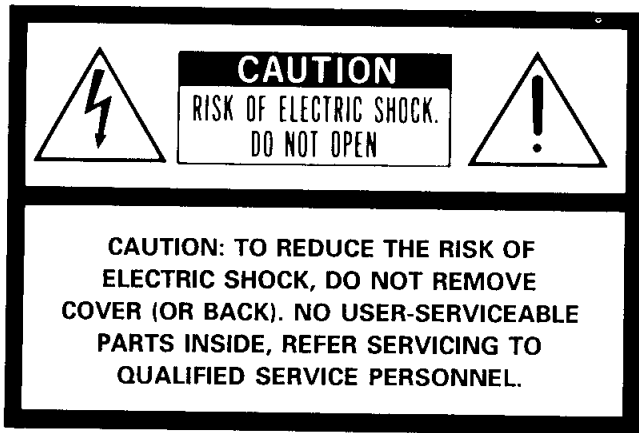

The exclamation point within an equilateral triangle is intended to alert the user to the presence of important operating and maintenance (servicing) instructions in the literature accompanying the product.



The lightning flash with arrowhead symbol, within an equilateral triangle, is intended to alert the user to the presence of uninsulated "dangerous voltage" within the product's enclosure that may be of sufficient magnitude to constitute a risk of electric shock to persons.

* This applies only to products distributed by YAMAHA CORPORATION OF AMERICA.

SPECIAL MESSAGE SECTION

ELECTROMAGNETIC INTERFERENCE (RFI): Your Yamaha Digital Musical Instrument Product has been type tested and found to comply with all applicable regulations. However, if it is installed in the immediate proximity of other electronic devices, some form of interference may occur. For additional RFI information see FCC Information section located in this manual.

IMPORTANT NOTICE: This product has been tested and approved by independent safety testing laboratories in order that you may be sure that when it is properly installed and used in its normal and customary manner, all foreseeable risks have been eliminated. **DO NOT** modify this unit or commission others to do so unless specifically authorized by Yamaha. Product performance and/or safety standards may be diminished. Claims filed under the expressed warranty may be denied if the unit is/has been modified. Implied warranties may also be affected.

SPECIFICATIONS SUBJECT TO CHANGE: The information contained in this manual is believed to be correct at the time of printing. Yamaha reserves the right to change or modify specifications at any time without notice or obligation to update existing units.

NOTICE: Service charges incurred due to a lack of knowledge relating to how a function or effect works (when the unit is operating as designed), are not covered by the manufacturer's warranty. Please study this manual carefully before requesting service.

NAMEPLATE LOCATION: The following graphic indicates the location of the Name Plate on your Yamaha Digital Musical Instrument. The Model, Serial Number, Power requirements, etc., are indicated on this plate.

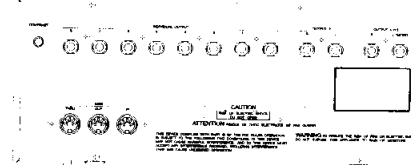

You should note the model, serial number and the date of purchase in the spaces provided below and retain this manual as a permanent record of your purchase.

Model _____

Serial No. _____

Purchase Date _____

STATIC ELECTRICITY CAUTION: Some Yamaha Digital Musical Instrument products have modules that plug into the unit to perform various function. The contents of a plug-in module can be altered/damaged by static electricity discharges. Static electricity build-ups are more likely to occur during cold winter months (or in areas with very dry climates) when the natural humidity is low. To avoid possible damage to the plug-in module, touch any metal object (a metal desk lamp, a door knob, etc.) before handling the module. If static electricity is a problem in your area, you may want to have your carpet treated with a substance that reduces static electricity build-up. See your local carpet retailer for professional advice that relates to your specific situation.

* This applies only to products distributed by YAMAHA CORPORATION OF AMERICA.

IMPORTANT SAFETY AND INSTALLATION INSTRUCTIONS

INFORMATION RELATING TO POSSIBLE PERSONAL INJURY, ELECTRIC SHOCK, AND FIRE HAZARD POSSIBILITIES HAS BEEN INCLUDED IN THIS LIST.

WARNING — When using electronic products, basic precautions should always be followed, including the following:

1. Read all Safety and Installation Instructions, Supplemental Marking and Special Message Section data, and any applicable assembly instructions **BEFORE** using this product.
2. Check unit weight specifications **BEFORE** you attempt to move this product.
3. Main power supply verification. Yamaha Digital Musical Instrument products are manufactured specifically for use with the main supply voltage used in the area where they are to be sold. The main supply voltage required by these products is printed on the name plate. For name plate location please refer to the graphic in the Special Message section. If any doubt exists please contact the nearest Yamaha Digital Musical Instrument retailer.
4. Some Yamaha Digital Musical Instrument products utilize external power supplies or adapters. Do **NOT** connect products of this type to any power supply or adapter other than the type described in the owners manual or as marked on the unit.
5. This product may be equipped with a plug having three prongs or a polarized line plug (one blade wider than the other). If you are unable to insert the plug into the outlet, contact an electrician to have the obsolete outlet replaced. Do **NOT** defeat the safety purpose of the plug. Yamaha products not having three prong or polarized line plugs incorporate construction methods and designs that do not require line plug polarization.
6. **WARNING** — Do **NOT** place objects on the power cord or place the unit in a position where any one could walk on, trip over, or roll anything over cords of any kind. An improper installation of this type can create the possibility of a fire hazard and/or personal injury.
7. Environment: Your Yamaha Digital Musical Instrument should be installed away from heat sources such as heat registers and/or other products that produce heat.
8. Ventilation: This product should be installed or positioned in a way that its placement or location does not interfere with proper ventilation.
9. Yamaha Digital Musical Instrument products are frequently incorporated into "Systems" which are assembled on carts, stands, or in racks. Utilize only those carts, stands, or racks that have been designed for this purpose and observe all safety precautions supplied with the products. Pay special attention to cautions that relate to proper assembly, heavier units being mounted at the lower levels, load limits, moving instructions, maximum usable height and ventilation.
10. Yamaha Digital Musical Instrument products, either alone or in combination with amplification, headphones, or speakers, may be capable of producing sound levels that could cause permanent hearing loss. Do **NOT** operate at high volume levels or at a level that is uncomfortable. If you experience any discomfort, ringing in the ears, or suspect any hearing loss, you should consult an audiologist.
11. Do **NOT** use this product near water or in wet environments. For example, near a swimming pool, spa, in the rain, or in a wet basement.
12. Care should be taken so that objects do not fall, and liquids are not spilled into the enclosure.
13. Yamaha Digital Musical Instrument products should be serviced by a qualified service person when:
 - a. The power supply/power adapter cord or plug has been damaged; or
 - b. Objects have fallen, or liquid has been spilled into the product; or
 - c. The unit has been exposed to rain; or
 - d. The product does not operate, exhibits a marked change in performance; or
 - e. The product has been dropped, or the enclosure of the product has been damaged.
14. When not in use, always turn your Yamaha Digital Musical Instrument equipment "OFF". The power supply cord should be unplugged from the outlet when the equipment is to be left unused for a long period of time. **NOTE:** In this case, some units may lose some user programmed data. Factory programmed memories will not be affected.
15. Electromagnetic Interference (RFI). Yamaha Digital Musical Instruments utilize digital (high frequency pulse) technology that may adversely affect Radio/TV reception. Please read FCC Information (inside front cover) for additional information.
16. Do **NOT** attempt to service this product beyond that described in the user maintenance section of the owners manual. All other servicing should be referred to qualified service personnel.

**PLEASE KEEP THIS MANUAL
FOR FUTURE REFERENCE!**

* This applies only to products distributed by YAMAHA CORPORATION OF AMERICA.

PRECAUTIONS

Data backup

It is possible for data in internal memory to be lost as a result of inappropriate operation or other reasons. We recommend that you keep backups of important voice data on a memory card (MCD64). It is also possible for the data in a memory card to be lost as a result of static electricity, magnetic fields, or other causes. For very important data it is always a good idea to make double backups.

Multi Play mode

If many multi-element voices are played simultaneously when in Multi Play mode, note timing may sometimes be slightly delayed. In such cases, select voices that use fewer elements, or reduce the number of notes.

Backup battery

The TG77 contains a backup battery which preserves settings such as for voice and multi data when the power is turned off. The life of this battery is approximately 5 years. However depending on the date of purchase, battery life may be shorter than this.

If the backup battery runs low, a message "Change int Battery!" will appear in the display when the power is turned on. If the backup battery runs down completely, the voice and multi data will be lost, so when this display appears, immediately store your data to a memory card and contact the dealer where you purchased the TG77 or your nearby Yamaha service station to have the battery replaced. When the battery is replaced, the internal voice and multi data will be lost, so be sure to save the data to a memory card first.

Third-party Software

Yamaha can not take any responsibility for software produced for this product by third-party manufacturers. Please direct any questions or comments about such software to the manufacturer or their agents.

The TG77 is always in either Multi mode or Voice mode.

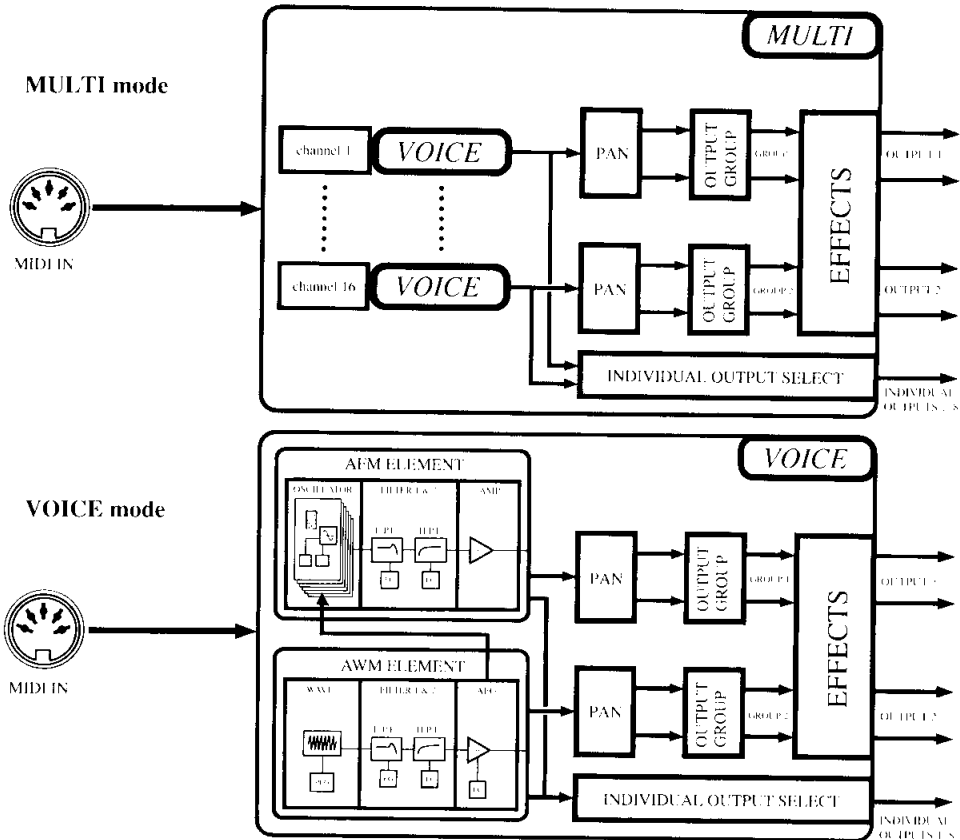

INTRODUCTORY SECTION

INTRODUCING THE TG77

HOW TO USE MULTI MODE

HOW TO EDIT A VOICE

REFERENCE SECTION

VOICE PLAY MODE

VOICE EDIT MODE

MULTI PLAY MODE

MULTI EDIT MODE

UTILITY MODE

APPENDIX

Thank you for purchasing the Yamaha TG77 tone generator. The TG77 represents a new generation of Yamaha synthesis technology; the Realtime Convolution and Modulation (RCM) hybrid tone generation system, which uses Advanced Frequency Modulation (AFM) tone generation and Advanced Wave Memory (AWM) tone generation in conjunction with realtime digital filtering.

The TG77 can function as up to 16 independent synthesizers, with both dynamic and static voice allocation. To take full advantage of the TG77 and enjoy long and trouble-free use, please read this manual carefully.

How to use this manual

This manual is divided into three sections; an introductory section, a reference section, and an appendix.

Introductory section: This section contains the information you need to start using your TG77 right away.

- **Introducing the TG77:** Please be sure to read this section. It will tell you how to play the TG77 from a MIDI keyboard, about the main features of the TG77, and about basic operation.
- **How to use Multi mode:** This explains how to use the TG77 in Multi mode to function as up to 16 independent MIDI tone generators. Read it when you want to play the TG77 from an external sequencer.
- **How to edit a Voice:** Read this when you want to modify a voice or create a completely new voice.

Reference section: This section contains a full explanation of all the TG77's functions. Once you have worked through the introductory section and are comfortable with basic operation, glance through this section to get an idea of the TG77's capabilities. Refer to the details when necessary.

Appendix: This section contains technical information that may be of interest to advanced users or programmers.

Conventions in this manual

In order to present information as clearly as possible, the following conventions are used in this manual.

- The names of front panel buttons and controls are set in small capital type; e.g., press the EDIT button.
- Italics are used mainly when referring to a section in this manual; e.g., for details refer to *AFM element job 5*. *AFM sensitivity*.
- Most of the LCDs in the TG77 have a unique Page Jump number to which you can jump by pressing JUMP and entering the number. These numbers will be prefixed by a “#” sign; e.g., JUMP #312.
- Function names will be capitalized when they first occur or when necessary for emphasis, but will be uncapitalized in subsequent occurrences; e.g., adjust the LFO Speed ... after adjusting the LFO speed, ...
- The beginning of each two-page subsection in the introductory section contains a short abstract or summary of the entire subsection, printed in bold type.
- Three periods between two numbers are used to indicate that a parameter can be set to any value in this range; e.g., Velocity Sensitivity (-7...+7). Since some parameters can be set to negative values, this avoids the possibility of confusing a dash with a minus sign.

CONTENTS

INTRODUCTORY SECTION

INTRODUCING THE TG77	3	HOW TO EDIT A VOICE	49
How to setup and play	4	What is a voice.....	50
How to load and play the ROM demo songs.....	8	What is an AWM element.....	52
How to use the TG77 with a sequencer.....	10	The basics of FM synthesis	54
About the TG77: RCM hybrid synthesis	12	What is an AFM element.....	56
About the TG77: AFM and AWM voices	14	The process of voice editing	58
About the TG77: pan, effects, and output.....	16	How voice edit mode is organized.....	60
Front panel.....	18	Simple editing: reverb (Effect)	62
Rear panel	22	Simple editing: tone (Filter)	64
How to move around: job directories.....	24	Simple editing: vibrato (LFO)	68
How to move around: the jump function.....	26	Simple editing: using a controller	70
How to enter data.....	28	Simple editing: attack (EG).....	72
How to use the numeric key pad	30	How to name and store your new voice.....	74
HOW TO USE MULTI MODE	33	How to edit a drum voice	76
Multi edit: initialize a multi and select			
voices	34		
Multi edit: volume, note shift, and panning	36		
Multi edit: output and effects.....	38		
How to name and store your new multi	42		
How to edit a voice from inside multi			
edit mode.....	44		

REFERENCE SECTION

VOICE PLAY MODE.....	81	1. Element level.....	90
Voice select	82	2. Element detune.....	91
Voice directory	82	3. Element note shift.....	91
Copy voice.....	83	4. Element note limit.....	92
Controller view	83	5. Element velocity limit.....	92
VOICE EDIT MODE	85	6. Element dynamic pan	93
Compare.....	87	6.0 Dynamic pan edit.....	94
Store voice	87	6.0.1 Copy pan data.....	95
Element on/off.....	88	6.1 Pan source	95
Element select	88	6.2 Pan EG.....	96
Voice mode select.....	89	6.3 Pan name.....	97
Common data.....	90	7. Output group select	97
Common data job directory	90	8. Random pitch.....	98
		9. Portamento.....	98

10. Effect set.....	98	Copy element.....	137
10.1 Effect mode select	99	1. AWM waveform set.....	138
10.1.1 Copy voice effect.....	100	2. AWM EG.....	140
10.2 (F1) Modulation effect 1 set (Data)....	100	3. AWM output.....	141
10.2 (F2) Modulation effect 1 set (Parameters).....	101	4. AWM sensitivity.....	142
10.4 (F1) Reverb effect 1 set (Data).....	102	5. AWM LFO.....	143
10.4 (F2) Reverb effect 1 set (Parameters).....	102	6. (F1) AWM pitch EG (Data).....	144
11. Micro tuning	105	6. (F2) AWM pitch EG (EG settings).....	144
11.0 Micro tuning edit.....	106	7. AWM filter.....	145
11.0.1 Copy micro tuning	107	15. Initialize AWM element.....	146
11.1 Micro tuning data.....	107	16. Recall voice	147
11.2 Micro tuning name.....	108	Drum set data.....	148
12. (F1) Controller set (Pitch bend).....	108	Drum set job directory	148
12. (F2) Controller set (Modulation).....	108	1. Voice volume.....	148
12. (F3) Controller set (Pan)	109	2. Wave data set	148
12. (F4) Controller set (Other).....	110	3. Effect set.....	150
13. Voice name.....	111	4. Controller set.....	150
14. Individual output select.....	111	5. Voice name	151
15. Initialize voice.....	112	7. Initialize voice.....	151
16. Recall voice.....	113	8. Recall voice.....	152
AFM element data.....	114	MULTI PLAY MODE	153
AFM element job directory	114	Multi select.....	155
Operator select.....	115	Multi directory	155
Operator on/off	115	Copy multi.....	156
AFM algorithm.....	115	MULTI EDIT MODE	157
Copy element.....	116	Compare.....	159
Copy operator	116	Store multi.....	159
1. (F1) AFM algorithm (Form).....	117	Multi edit job directory	159
1. (F2) AFM algorithm (External input)....	118	1. Voice select	160
1. (F3) AFM algorithm (Input level)	119	2. Voice volume.....	161
2. AFM oscillator.....	120	3. Voice tuning	162
3. (F1) AFM operator EG (Each operator)	122	4. Voice note shift.....	162
3. (F2) AFM operator EG (All operators)	124	5. Voice static pan.....	163
4. (F1) Operator output (Each).....	124	6. Voice output group select	163
4. (F2) AFM operator output (All).....	125	7. Effect set.....	164
5. AFM sensitivity	126	8. Multi name.....	164
6. (F1) AFM LFO (Main).....	127	9. Voice individual output select.....	165
6. (F2) AFM LFO (Sub).....	127	10. Assign mode select JUMP.....	165
7. (F1) AFM pitch EG (Switch).....	128	10.0 SVA edit	166
7. (F2) AFM pitch EG (EG settings).....	129	15. Initialize multi	167
8. AFM filter	130	16. Recall multi.....	168
8.0 Copy filter.....	130	UTILITY MODE.....	169
8.1 Cutoff frequency	131	System utility.....	171
8.2 Cutoff scaling	133	1. Master tuning	171
8.3 Cutoff EG	133	2. Velocity set.....	171
15. Initialize AFM element	134	3. Edit confirm.....	172
16. Recall voice.....	136	4. Greeting message.....	173
AWM element data.....	137	MIDI utility.....	174
AWM element job directory	137	1. Channel set.....	174
		2. Program change.....	175

2.0 Program change table edit.....	176
3. Bulk dump.....	177
Card utility.....	178
1. Save to card.....	178

2. Load from card	179
3. Format card.....	179
Demo utility	180

APPENDIX

Explanation of the preset voices	184
Preset 1.....	184
Preset 2.....	185
Preset drum voice key assignments.....	187
Using RCM hybrid synthesis.....	188
Suggestions for using AWM + AFM (Voice modes 9 & 10)	188
Error messages.....	190

MIDI	190
Data card	190
Wave card.....	190
Battery	190
Other	191
Multi data blank chart	192
Specifications.....	193
Index	194

INTRODUCTORY SECTION

INTRODUCING THE TG77

This section will tell you how to play the sounds, introduce you to the main features of the TG77, and explain basic operation.

Contents of this section	page
How to setup and play	4
How to load and play the ROM demo songs.....	8
How to use the TG77 with a sequencer	10
About the TG77: RCM hybrid synthesis.....	12
About the TG77: AFM and AWM voices	14
About the TG77: pan, effects, and output.....	16
Front panel	18
Rear panel.....	22
How to move around: job directories	24
How to move around: the jump function	26
How to enter data	28
How to use the numeric key pad.....	30

How to setup and play

The first thing you will probably want to do is play the voices (sounds) of your new TG77. Here's how to select and play the TG77's voices.

Connections

Make sure that your amp/speaker system and the TG77 are switched off. Connect the rear panel output OUTPUT 1/1+2 jacks (L/MONO and R) to the inputs of your amp/speaker system. Or, if you are using a set of stereo headphones, plug them into the front panel PHONES jack.

Use a MIDI cable to connect the MIDI OUT of your keyboard (or other MIDI instrument) to the MIDI IN of the TG77.

Note:

To use the TG77, you will need a separate MIDI instrument such as a MIDI keyboard, MIDI wind controller, MIDI guitar, MIDI sequencer, or other device capable of transmitting MIDI data. In this manual, we will assume you are playing the TG77 from a MIDI keyboard. If you are using a different type of MIDI controller, read all references to "MIDI keyboard" in this manual as referring to your MIDI controller.

Turn the power on

Turn down both of the TG77's two concentric VOLUME knobs to the MIN position. The knobs are located at the left side of the front panel. Then turn the power on by pressing the POWER switch located at the lower left. After displaying a greeting message for about two seconds, a display similar to the following should appear. If the TG77 was in Voice Play mode when the power was last turned off, the upper left of the LCD will read "VOICE".

```
VOICE=P1-A01(01) 100
SP:Cosmo 1AFM&1AWM
MD= 1 Mod1:Chorus Rev1:Rev Hall
      Mod2:SymPho Rev2:Delay L,R
      Ctrl Dir
```

If the upper line of the display does not show VOICE then press the VOICE button located at the upper left of the front panel.

Make sure that the volume of your amp/speaker system is turned down, and turn its power on. Set the volume of your amp/speaker system to an appropriate level, and gradually raise the TG77's OUTPUT 1 and 2 knobs while playing your MIDI keyboard. If you don't hear anything, re-check MIDI and audio connections, and make sure that your amp/speaker system is functioning correctly.

How to select and play voices

The sound produced by the TG77 in response to a single incoming channel of MIDI data is defined as a Voice. In Voice mode (i.e., when the VOICE LED is lit) you can select and play one voice at a time. The TG77 has 128 voices that are preset in permanent memory, and 64 memories for you to store your own newly created voices. An optional RAM or ROM card can be inserted into the VOICE card slot to provide 64 more voices.

The preset voices are organized into two locations; PRESET 1 and PRESET 2. Each of these has four banks (A–D) with 16 voices in each. The LCD shows the ten-character voice name, and also tells you which memory the voice is from. The number in parentheses indicates what number the voice would be if we started counting from the beginning of the bank.

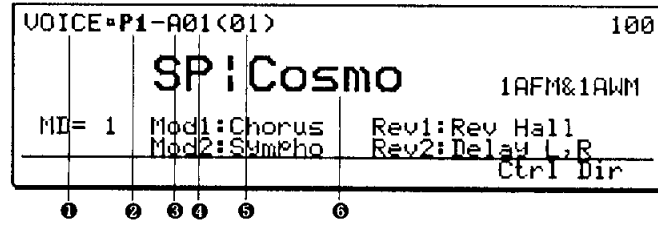

- ❶ This indicates that you are in Voice Play mode.
- ❷ Memory PRESET 1.
- ❸ Bank A.
- ❹ Voice number “1” of bank A.
- ❺ If we count from the beginning of the bank, this is Voice number 1.
- ❻ The voice name is “SP|Cosmo”.

You will learn about the other parts of the display later. For now, here’s how to select voices.

1. Press the MEMORY button to select the voice memory. Each time you press the MEMORY button, you will cycle through Preset 1, Preset 2, Internal, and Card (if a card is inserted into the DATA slot). The upper left of the LCD will indicate the selected memory.
2. Select a voice 1–64 by pressing the -1 +1 keys or by using the numeric keypad to enter a one or two digit number and pressing ENTER. You can also press the BANK/SELECT button to cycle through banks A, B, C, and D. The upper left of the LCD will indicate the selected bank.

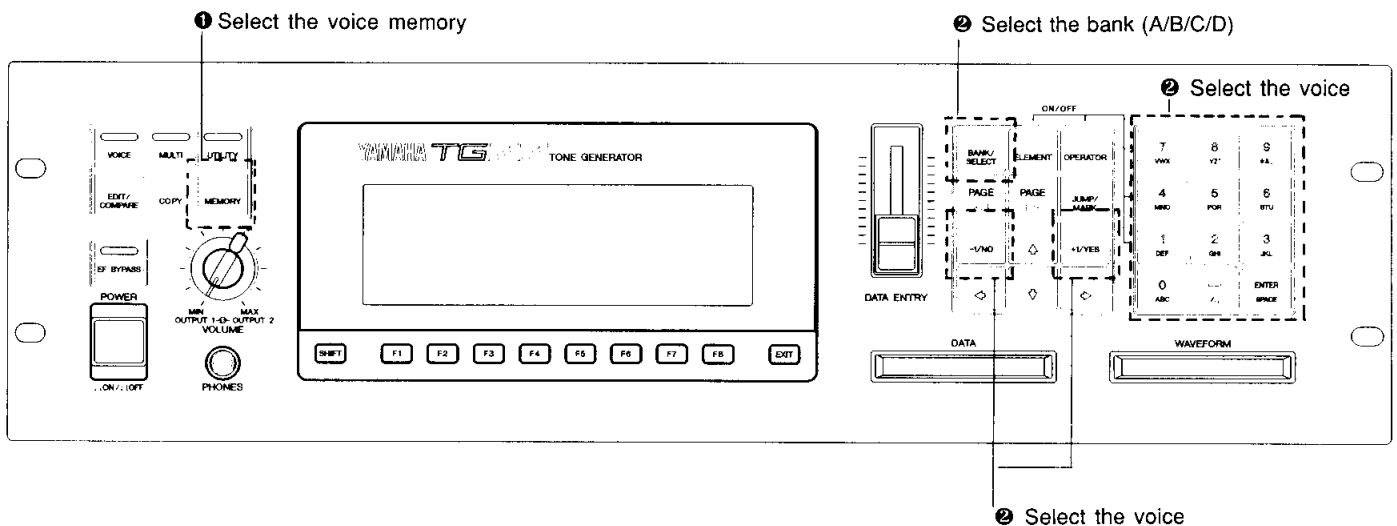

Note:

You can also select TG77 voices by transmitting program change messages from your keyboard. When shipped, the TG77 is set up so that MIDI program change messages 1–64 will select the 64 voices in the currently selected voice memory. Press the MEMORY key to cycle through Internal, Card (if a card is inserted into the DATA slot), Preset 1, and Preset 2.

If the program change messages you transmit do not select the desired voice, refer to MIDI Utility, 2. Program change, page 175, and set the Program Change parameter to “normal”.

Go ahead and try out each of the preset voices. When you are ready to learn more about the TG77, continue reading.

PRESET 1 (64 voices)

#	Bank A	Bank B	Bank C	Bank D
1	SP Cosmo	BR Plucky	ME St.Mick	ST Ripper
2	SP Metroid	BR BigBand	ME Blade	ST Violins
3	SP Diamond	BR 1980	ME Forest	ST Section
4	SP Sqrpad	BR Trmpets	ME Gargoyl	ST SynStrg
5	SP Arianne	BR ModSyn	ME Pikloop	ST Chamber
6	SP Sawpad	BR Ensembl	ME Aquavox	BA Frtless
7	SP Darkpad	BR FrHorn	ME Alps	BA Starred
8	SP Mystery	BR Soul	ME Cycles	BA HardOne
9	SP Padfaze	BR FM Bite	WN Bluharp	BA VC1
10	SP Twilite	EP IceRing	WN Tenor	BA VC2
11	SP Annapad	EP Synbord	WN Clarino	BA VC3
12	AP Ivory	EP GS77	WN AltoSax	BA Rox
13	AP CP77	EP Knocker	WN Moothie	BA Woodbas
14	AP Bright	EP Beltine	WN Saxion	BA Round
15	AP Hammer	EP Dynamod	WN Flute	BA Erix
16	AP Grand	EP Urbane	WN Ohboy	BA FMFrtls

PRESET 2 (64 voices)

#	Bank A	Bank B	Bank C	Bank D
1	SC Newworld	KY Bosh	OR YC45D	SE Goto>1
2	SC Stratos	KY Wahclav	OR Pipes	SE Xpander
3	SC Ripples	KY Wires	OR Jazzman	SE Inferno
4	SC Digitak	KY Tradclv	OR Combo	SE Them!!!
5	SC Hone	KY Thumper	PC Marimba	OR Gassman
6	SC Spaces	KY Modclav	PC OzHamer	BR ZapBras
7	SC Sybaby	PL Sitar	PC Tobago	BR BrasOrc
8	SC Icedrop	PL Harp	PC Vibes	PL Stairwy
9	SC Wired	PL Saratog	PC Glass	ST Widestg
10	SL Gnome	PL Steel	PC Island	ST Symflow
11	SL SawMono	PL Tweive	PC GrtWall	ST Quartet
12	SL SqrMono	PL Shonuff	CH Itopia	ST Tutti
13	SL Pro77	PL MutGtr	CH GaChoir	ME Voyager
14	SL Nester	PL Guitar	CH Chamber	ME Galaxia
15	SL Eazy	PL Shami	CH Spirit	DR Both
16	SL Lips	PL Koto	CH ChorMst	DR Group2

Preset voice names

The first two characters of each preset voice name indicate the type of voice, and the third character indicates how many elements the voice uses. As explained later, a voice that uses more elements will be able to play fewer simultaneous notes.

The first two characters of preset voice names indicate the type of voice

SP	Synth Pad
AP	Acoustic Piano
BR	Brass
EP	Electric Piano
ME	Musical Effect
WN	Winds
ST	Strings
BA	Basses
SC	Synth Comp
SL	Synth Lead
PL	Plucked
KY	Keyboards
OR	Organ
PC	Percussion
CH	Choir
SE	Sound Effects
DR	Drum Voices

The third character of preset voice names indicates the number of elements used by the voice

.	1 element	1AFM or 1AWM
:	2 elements	2AFM or 2AWM
!	2 elements	1AFM & 1AWM
*	4 elements	4AFM or 4AWM or 2AFM & 2AWM

Note when using SY77 voice cards

When using the TG77 to play voices (either from a voice data card or loaded via MIDI bulk dump) that were created for the SY77, be aware that many SY77 voices are designed to take advantage of the SY77's unique MODULATION 2 wheel, for example to fade between components of the sound, or to control the tone. To check the controller assignments of a voice, refer to 12. (F1-F4) *Controller set* on pages 108-110.

If the SY77 voice you are playing on your TG77 is set to respond to MIDI Control Change number 13 (the default assignment of the SY77's MODULATION 2 wheel), MIDI control number, you have two options. If your MIDI keyboard allows you to specify the messages transmitted by each controller (wheel, pedal, etc.), set a controller to transmit MIDI Control Change 13. If your MIDI keyboard does not allow you to do this, you will have to edit the voice so that it responds to a Control Change number that is transmitted by your keyboard.

How to load and play the ROM demo songs

The TG77 contains demo songs which take advantage of its capabilities. These songs are stored in ROM (permanent memory), and cannot be erased or modified. Here's how to play the songs.

Note:

The setup parameters (the Utility mode settings for master tuning, velocity curve, etc.) will be overridden in demo mode. When you exit demo mode, the setup parameters will be restored.

Enter Utility mode and load the demo data

Press the UTILITY button, and then press F4 (Demo) to get the following display.

If you have been editing voice or multi data, the top line of the LCD will blink "AUTO-STORE". If you wish to keep the edited data, refer to page 87 (Store voice) or page 159 (Store multi). Otherwise, press F7 (Quit).

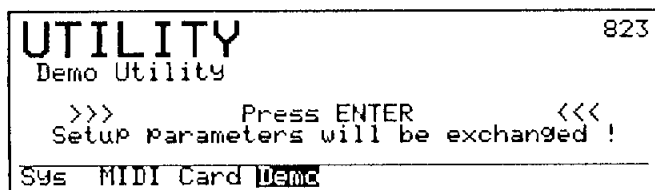

If the EF BYPASS button has been pressed, effect bypass will be turned off when the demo data is loaded.

Select the demo song from which to begin

When you press ENTER to load the demo data, the Top Song Select display will appear. The TG77's demo song play function plays all songs in continuous rotation, starting from the song you select. Use the DATA ENTRY slider, the -1/+1 keys, or the numeric keypad to select the demo song from which to begin playing.

Begin playing from the selected demo song

After selecting a demo song from which to begin, press the F8 (Play) button. The LCD will indicate the number and name of the currently playing song, and vertical VU-meter-style bar graphs will indicate when each channel (1-16) is sounding.

When one song ends, the next will begin immediately.

To stop the demo songs, press F8 (Stop).

To resume playing, press F8 (Play).

To exit Demo Play mode, stop the demo playback and then press EXIT or a mode key VOICE, MULTI, or UTILITY.

While the demo songs are playing, you can press the following keys.

- F1 (Ch): A VU meter-style graphic indicates when each channel is sounding.
- F2 (Note): A VU meter-style graphic indicates the notes played.
- F3 (Kbd): Both keyboard and VU-meter graphics will be displayed.
- F4 (Name): The names of the voices in the multi will be displayed.
- F5 (Time): The display will indicate the elapsed time since the beginning of the currently playing song, and the elapsed time since the play button was pressed.
- F6 (Auto): The above graphics will automatically alternate approximately every five seconds.
- F8 (Stop): Stop the demo.

How to use the TG77 with a sequencer

In Multi mode, the TG77 is able to function as 16 independent synthesizers, each controlled on its own MIDI channel. This makes the TG77 especially suitable for use with a MIDI sequencer. This section will explain the simplest way to use the TG77 as a tone generator module for a multi-track MIDI sequencer.

Make connections and prepare your sequencer for playback

Connect the MIDI OUT of your sequencer to the MIDI IN of the TG77. Load data into your sequencer, and prepare it to playback.

Select a Multi

In multi mode the TG77 can function as 16 independent synthesizers. The multi settings determine which voices are played by each incoming channel of MIDI data, how the voices are output, and many other aspects of the sound. A more extensive tutorial is provided beginning from page 33, but this page will give you an idea of how to use multi mode.

1. Press MULTI to enter multi mode. The MULTI LED will light red, and a display similar to the following will appear.

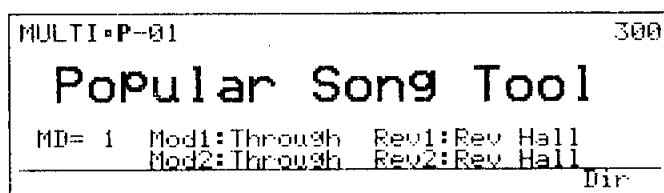

2. If the upper left of the LCD does not already show "P" (preset), press the MEMORY button until the "P" appears.
3. Use the -1/+1 keys or the numeric keypad to select one of the 16 preset multis. The following chart shows the voice numbers used for each channel of the preset multis.

Note 1:

Check the data in your sequencer to see which MIDI channels it uses, and select a preset multi on the TG77 that will be appropriate. For most of the preset multis, a drum-type voice is assigned to MIDI channel 16. If the data in your sequencer contains a drum part, set it to transmit on channel 16. You may need to change the note numbers of your sequencer drum part to be more appropriate for the selected drum voice of the TG77.

Note 2:

None of the preset multis use all 16 MIDI channels, but of course you can edit your own multi to use all 16 channels if you wish. The preset multis (and this example) are purposely kept simple. The tutorial beginning on page 33 will explain more possibilities of the TG77's multi mode.

Start playback on your sequencer

Start playback on your sequencer. When the TG77 receives MIDI data, the MULTI LED will blink. If the TG77 produces no sound even though the MULTI LED blinks, check that the channels being transmitted from the sequencer match the channels for which the selected TG77 multi has assigned a voice.

No.	Multi Name	1	2	3	4	5	6	7	8	9	10	11	12	13	14	15	16
1	Popular Song Tool	P1-B14	P1-A14	P1-D08	P2-B10	P1-B04	P1-D03	P1-C14	P2-A11	P2-C12	P2-C03	[off]	[off]	[off]	[off]	P2-D16	P2-D15
		EP:Beltime	AP:Bright	BA:HardOne	PL:Steel	BR:Trmpets	ST:Section	WN:Saxion	SL:SawMono	CH:Itopia	OR:Jazzman					DR:Group2	DR:Both
2	Modern Tune	P1-A13	P1-D11	P1-B05	P1-A01	P2-B12	P2-A14	[off]	[off]	[off]	[off]	[off]	[off]	[off]	[off]	[off]	P2-D15
		AP:CP77	BA:VC3	BR:ModSyn	SP:Cosmo	PL:Shonuff	SL:Nester									[off]	DR:Both
3	Funky Staff	P1-B11	P1-D07	P1-B03	P2-C13	P2-A15	P1-C10	[off]	[off]	[off]	[off]	[off]	[off]	[off]	[off]	P2-D16	P2-D15
		EP:Synbord	BA:Starred	BR:1980	CH:GaChoir	SL:Easy	WN:Tenor									DR:Group2	DR:Both
4	Ballad Scene	P1-B10	P1-A12	P1-D6	P1-D03	P1-C15	P1-A10	P2-B08	[off]	[off]	[off]	[off]	[off]	[off]	[off]	[off]	P2-D15
		EP:IceRing	AP:Ivory	BA:Friless	ST:Section	WN:Flute	SP:Twille	PL:Harp									DR:Group2
5	Jazz Quintet	P1-A16	P1-D13	P2-B10	P1-C15	P1-C10	[off]	[off]	[off]	[off]	[off]	[off]	[off]	[off]	[off]	[off]	P2-D16
		AP:Ganc	BA:WoodBas	PL:Steel	WN:Flute	WN:Tenor											DR:Group2
6	Big Band Jazz	P1-A16	P1-D13	P1-C15	P1-C11	P1-C12	P1-C10	P1-B04	P1-B06	[off]	[off]	[off]	[off]	[off]	[off]	[off]	P2-D16
		AP:Grand	BA:WoodBas	WN:Flute	WN:Clarino	WN:AltoSax	WN:Tenor	BR:Trmpets	BR:Ensembl								DR:Group2
7	Beethoven Symphony	P1-C15	P1-C16	P1-C11	P1-C16	P1-B07	P1-B04	P1-B06	P1-D03	P1-D05	P1-D03	P1-D05	P1-D13	[off]	[off]	[off]	P2-D16
		WN:Flute	WN:Obboy	WN:Clarino	WN:Obboy	BR:FrHorn	BR:Trmpets	BR:Ensembl	SS:Section	ST:Chamber	ST:Section	ST:Chamber	BA:Woodbas			DR:Group2	DR:Group2
8	Wind Ensemble	P2-B08	P1-C15	P1-C16	P1-C11	P1-C12	P1-C10	P1-B04	P1-B06	P1-B05	P1-D13	P1-A01	P1-A01	[off]	[off]	[off]	P2-D16
		PL:Harp	WN:Flute	WN:Obboy	WN:Clarino	WN:AltoSax	WN:Tenor	BR:Trmpets	BR:Ensembl	BR:ModSyn	BA:Woodbas	SP:Cosmo	SP:Cosmo				DR:Group2
9	South America	P1-B13	P2-C10	P1-D03	P2-B13	P2-C04	P2-C07	P1-C15	P1-B04	[off]	[off]	[off]	[off]	[off]	[off]	[off]	P2-D15
		EP:Knocker	PC:Island	BA:HardOne	PL:MultiGr	OR:Comoo	PC:Tobago	WN:Flute	BR:Trmpets								DR:Both
10	Folklore	P1-C13	P1-A15	P1-D13	P2-B08	P1-D02	P1-C15	P1-C11	[off]	[off]	[off]	[off]	[off]	[off]	[off]	[off]	P2-D15
		WN:Moothie	AP:Hammer	BA:WoodBas	PL:Harp	ST:Violins	WN:Flute	WN:Clarino									DR:Both
11	Country & Western	P2-B10	P1-A14	P1-D14	P1-C09	P2-A16	P1-A01	[off]	[off]	[off]	[off]	[off]	[off]	[off]	[off]	[off]	P2-D16
		PL:Steel	AP:Bright	BA:Round	WN:Blotchp	SL:Lips	SP:Cosmo										DR:Group2
12	Baroque Quartet	P2-B03	P1-D02	P1-C16	P1-C15	[off]	[off]	[off]	[off]	[off]	[off]	[off]	[off]	[off]	[off]	[off]	P2-D16
		KY:Wires	ST:Violins	WN:Obboy	WN:Flute												DR:Group2
13	Pot Pourri	P1-A16	P1-D03	P1-B04	P2-C09	P2-A11	P2-D12	P1-B11	P1-D13	P2-C05	P2-B14	P1-C15	P2-C07	P2-C01	P1-D06	P2-B09	P2-D16
		AP:Grand	ST:Section	BR:Trmpets	PC:Glass	SL:SawMono	ST:Tutti	EP:Synbord	BA:WoodBas	PC:Marimba	PL:Guitar	WN:Flute	PC:Tobago	OR:YC45D	BA:Friless	PL:Saratog	DR:Group2
14	It's Cool!!	P1-A12	P1-B02	P1-D16	P1-B16	P1-B12	P2-B07	P1-B07	P1-D03	P2-C12	P2-D16	P2-B06	P2-A16	P2-A06	P2-D10	P2-C03	P2-B09
		AP:Ivory	BR:BigBand	BA:FM:rtis	EP:Urbane	EP:GS77	PL:Sitar	BR:FrHorn	ST:Section	CH:Itopia	DR:Group2	KY:Modclav	SL:Lips	SC:Spaces	ST:Synthlow	OR:Jazzman	PL:Saratog
15	Powerplay	P2-B05	P2-B13	P1-D01	P1-D03	P1-B10	P2-C09	P1-B04	P2-C12	P1-B05	P1-B05	P1-B03	P1-B11	P1-A14	P2-D14	P2-B12	P2-D16
		KY:Thumper	PL:MultiGr	BR:Plucky	ST:Section	EP:IceRing	PC:Glass	BR:Trmpets	CH:Itopia	BR:ModSyn	BR:ModSyn	BR:1980	P2-C14	AP:Bright	ME:Galaxia	PL:Shonuff	DR:Group2
16	House Demo P Ellis	P1-A01	P1-C06	P1-C03	P1-C05	P1-D07	P2-D16	P1-C02	P2-C13	P1-D03	P2-D16	P2-A16	P2-C14	P2-D01	P1-B11	P2-D16	P2-D15
		SP:Cosmo	ME:Aquavox	ME:Cycles	ME:Pc:oop	BA:Starred	DR:Group2	ME:Blade	CH:GaChoir	BR:1980	DR:Group2	SL:Lips	CH:Chamber	BE:Goto>1	EP:Synbord	DR:Group2	DR:Both

Note: Preset multi-13-16 are used in the ROM demo songs. See page 8.

About the TG77: RCM hybrid synthesis

The TG77's RCM hybrid tone generation system fuses the realism of digital samples with the expressive power of FM. It uses Advanced Wave Memory 2 (AWM2) and Advanced Frequency Modulation (AFM) in conjunction with digital filters to allow a wide variety of sound creation techniques.

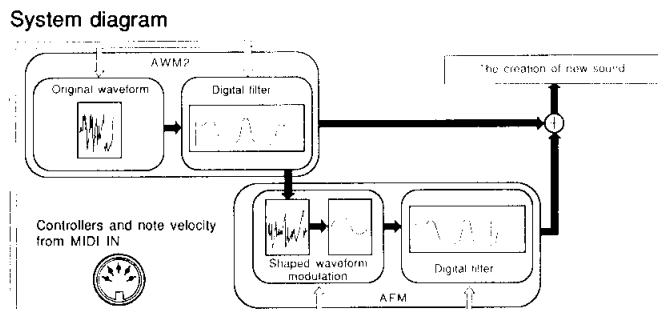

Advanced Wave Memory 2 (AWM2)

AWM2 uses 16 bit linear sample reproduction with proprietary Yamaha convolution technology (digital filtering) that allows you to emphasize or cut any desired portion of the frequency spectrum with full realtime control.

Advanced Frequency Modulation (AFM)

In addition to advancing beyond the FM synthesis capabilities of the DX7 and previous Yamaha synthesizers, AFM allows you to filter and envelope any AWM waveform and use the shaped waveform it as part of an FM algorithm to apply frequency modulation, creating partials that were not present in the original AWM waveform. This modulated waveform can be processed by additional digital filtering.

Dynamic touch and control

One of the greatest advantages of RCM hybrid tone generation is that it fuses the realism of digital sampling with the expressive power of FM. Keyboard dynamics and controllers can be used to control nearly any aspect of the sound, allowing great musical expressiveness.

The possibilities of RCM hybrid synthesis

The TG77 allows a wide variety of synthesis techniques to be used, and digital filtering is always provided for each AFM or AWM element. The following diagrams show how the RCM hybrid synthesis system can simulate many of the analog and digital synthesizers of the past.

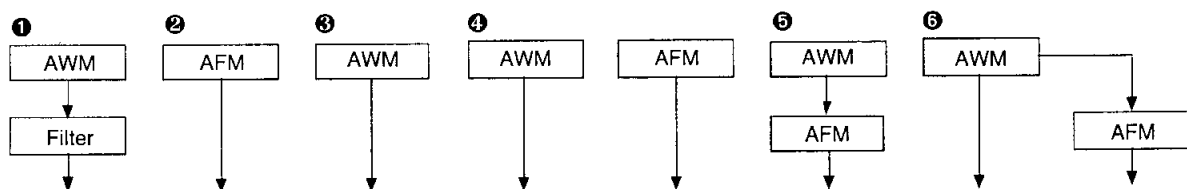

- 1 Filter style "analog" synthesis: Single cycle AWM waveforms can be enveloped and filtered to simulate analog synthesizers. (Various sawtooth and pulse waves are provided, and the TG77's filters can be configured as 24dB/octave filters with resonance adjustable into oscillation.)

- ② Traditional FM: The AFM tone generator can be used alone to produce any sound that the DX series was capable of, and much more.
- ③ AWM sample playback: The AWM tone generator can be used alone, to playback high quality digital samples from internal AWM memory or an optional waveform card.
- ④ AWM sample playback mixed with FM: The sounds of the AWM and AFM tone generators can be layered.
- ⑤ FM modulated by AWM: AWM digital samples can be used to modulate one or more operators in an FM algorithm, for very complex FM sounds.
- ⑥ AWM sample playback + FM modulated by AWM: In a variation of ⑤, the original sound of the AWM sample can be mixed with the complex AFM sound.

For techniques which use both AWM and AFM (④ ⑤ ⑥) there are two additional possibilities.

- Both AFM and AWM can be used to create sustaining sounds.
- The AFM and AWM tone generators can be used to create different components of the sound, with short transient AWM waveforms used to create an attack and the AFM tone generator used to create the sustain component of the sound (or vice versa).

Since each voice can use one, two, or four AFM or AWM elements, these synthesis strategies can be combined in complex ways.

About the TG77: AFM and AWM voices

The TG77 produces sound using two proprietary Yamaha technologies; Advanced Frequency Modulation (AFM) synthesis and Advanced Wave Memory (AWM). A special Drum Voice assigns a different AWM percussion sound to each of the 61 notes in the range C1–C6.

AFM — Advanced Frequency Modulation

Frequency Modulation (FM) is a patented Yamaha technology for producing complex and musical controllable sounds, and was first made famous by the DX7 synthesizer. The TG77's Advanced FM (AFM) takes FM synthesis to new levels of realism, expression, and programmability.

Each of the six FM operators in the TG77 can use one of 16 different waveforms, and be connected to each other in 45 basic algorithms (patterns). In addition, each operator has two inputs which can be modulated by feedback from any other operator, from a noise generator, or from an AWM sample. Compared to previous FM instruments, many parameters have a wider range of control, and the TG77 envelope generators have six segments with looping.

AFM can produce sounds that change dramatically in response to your playing, allowing a wide range of expressiveness.

AWM — Advanced Wave Memory

Advanced Wave Memory (AWM) is a patented Yamaha technology for storing and reproducing digital sound. The TG77 contains 2 Mwords (4 Mbytes) of AWM samples in Read Only Memory (ROM), including piano, strings, choir, and percussive sounds among many others. Optional cards can be inserted into the front panel WAVEFORM slot to make additional sounds available. The sounds are sampled in 16-bit linear format with a maximum sampling frequency of 48 kHz.

AWM sounds are high-quality digital recordings of actual instruments.

A voice consists of one, two, or four Elements

Each sound that you have been playing is defined as a Voice, and consists of one, two, or four Elements. (The drum voice explained below is a special case.) Each of these elements is actually the equivalent of an independent synthesizer; either AFM or AWM.

An element can be set to produce sound for only a specific range of the keyboard, or for a specific range of velocities. This allows you to create a voice which produces different sounds for different ranges of the keyboard, or for loudly or softly played notes.

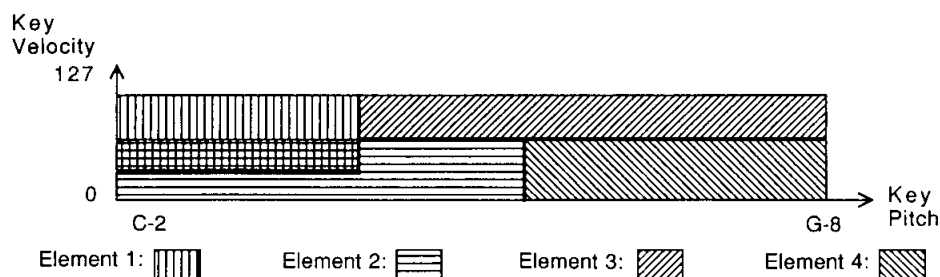

The one, two, or four elements in a voice can produce many types of keyboard split and layer effects.

On earlier Yamaha synthesizers such as the DX7-II, layers and splits were created by combining two or more Voices into a "Performance". This meant that sometimes you played Voices and other times you played Performances. However on the TG77, layers and splits can be included in a voice, so you can simply select a voice and play without considering whether it contains layers or splits.

Two realtime digital filters for each element

Each AFM or AWM element in a voice includes two 12 dB/octave realtime digital filters, each filter independently controlled by its own envelope generator (EG). One filter is fixed as a Low Pass Filter (LPF) and the other filter can be used either as a LPF or a High Pass Filter (HPF). This allows you to use the two in conjunction to create a 12 dB/octave Band Pass Filter (BPF) or a 24 dB/octave LPF. Veterans of analog synthesizers will be happy to hear that the filter resonance (or "Q") can be adjusted all the way into filter oscillation.

Since a voice can consist of one, two, or four elements, a single voice can use 2, 4 or 8 independent filters.

AFM x AWM x Filtering = the TG77

The TG77 can utilize most of the programming techniques of previous synthesizers; FM, sample playback, and realtime filtering. This means that the TG77 can produce the sounds of the classic 24 dB/octave analog synthesizers of the past, the FM sounds of the DX series, the sampled sounds of many of today's instruments ... and also sounds that have never been heard before.

Play up to 16 AFM notes and 16 AWM notes at once

The TG77 contains two tone generators; an AFM tone generator and an AWM tone generator. The AFM tone generator can produce up to 16 simultaneous notes of FM sound, and the AWM tone generator can produce up to 16 simultaneous notes of digitally sampled sound.

Some voices consist of only one element, some of two elements, and others of four elements. (The Voice mode setting inside each voice determines how many elements are used.) The important thing to remember is that up to a total of 16 notes of AFM sound and 16 notes of AWM sound can be sounding at any time. If a voice plays two or more elements for a single key, the sound will be more complex and richer, but you will be able to play fewer simultaneous notes.

A Drum voice consists of 61 percussive sounds

In addition to the "normal" voices explained above which consist of one, two, or four elements, the TG77 provides a special type of voice; the Drum voice. A drum voice has no elements, but consists of a different AWM sample for each of the 61 keys in the range C1-C6.

A drum voice can be played from your MIDI keyboard (or other MIDI controller) just like a normal voice. Usually you will use a sequencer to play a drum voice, providing drums and percussion accompaniment.

There is no distinction between normal voice memory and drum voice memory; either type of voice can be stored in any of the voice memories.

About the TG77: pan, effects, and output

Each of the one, two, or four elements in a voice has two independent digital filters, and is sent through its own pan table. The TG77 also has four built-in digital effect processing (DSP) effect units, and effect settings are stored as part of each voice. In addition to the two pairs of stereo outputs from the DSP effect system, the TG77 provides 8 individual outputs to which you can assign the un-panned un-processed sound of a voice.

Dynamic pan table for each element

Each element in a voice is sent through a pan table (64 preset and 32 user pan tables are provided) that determines how the sound will move between the left and right outputs. Each pan table has its own EG, and also allows you to select a pan source (velocity, key note number, or LFO). Another controller can be used to further bias the panning movement.

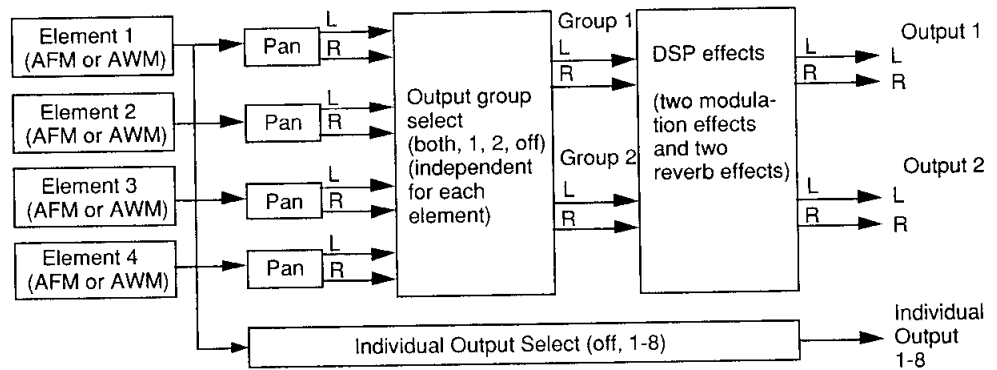

Four DSP effects

The stereo output from the voice is sent through the voice output group selector (both, group 1, group 2, or off) to the DSP effects section. The TG77 contains two modulation-type effect units and two reverb-type effect units.

Each modulation-type effect unit can produce four different effects: chorus, flanger, symphonic, or tremolo. Each reverb-type effect unit can produce 40 different effects, including several types of reverb, delay, tone control, distortion, and various combinations of these. All effect parameters are fully adjustable. The sound from the two output groups can be sent through these four effect units in three different routes.

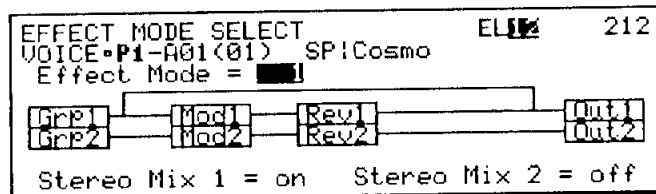

Eight individual outputs

In addition to the two pairs of stereo outputs from the DSP effect system, the TG77 provides 8 individual outputs to which you can assign the un-panned un-processed sound of a voice. This is convenient when you wish to use an external effects device or mixer to add special processing to a specific voice. For example when playing the TG77 in voice mode, you might want to route sound through a fuzz box connected to individual output 1 whenever you select a guitar voice.

In multi mode, each voice has full control of pan and output group, exactly the same as in voice mode. (The DSP effect system is shared by all 16 voices of the multi.) Each voice in the multi also has its own individual output assignment, and two or more voices of the multi can use the same individual output if desired. For example, you might send a guitar voice from individual output 1 to an external fuzz box, while sending an organ voice from individual output 2 to an external rotary speaker.

Front panel

In order to understand the rest of this manual and take full advantage of the TG77, you will need to know the names and uses of the controls and other features of the front panel.

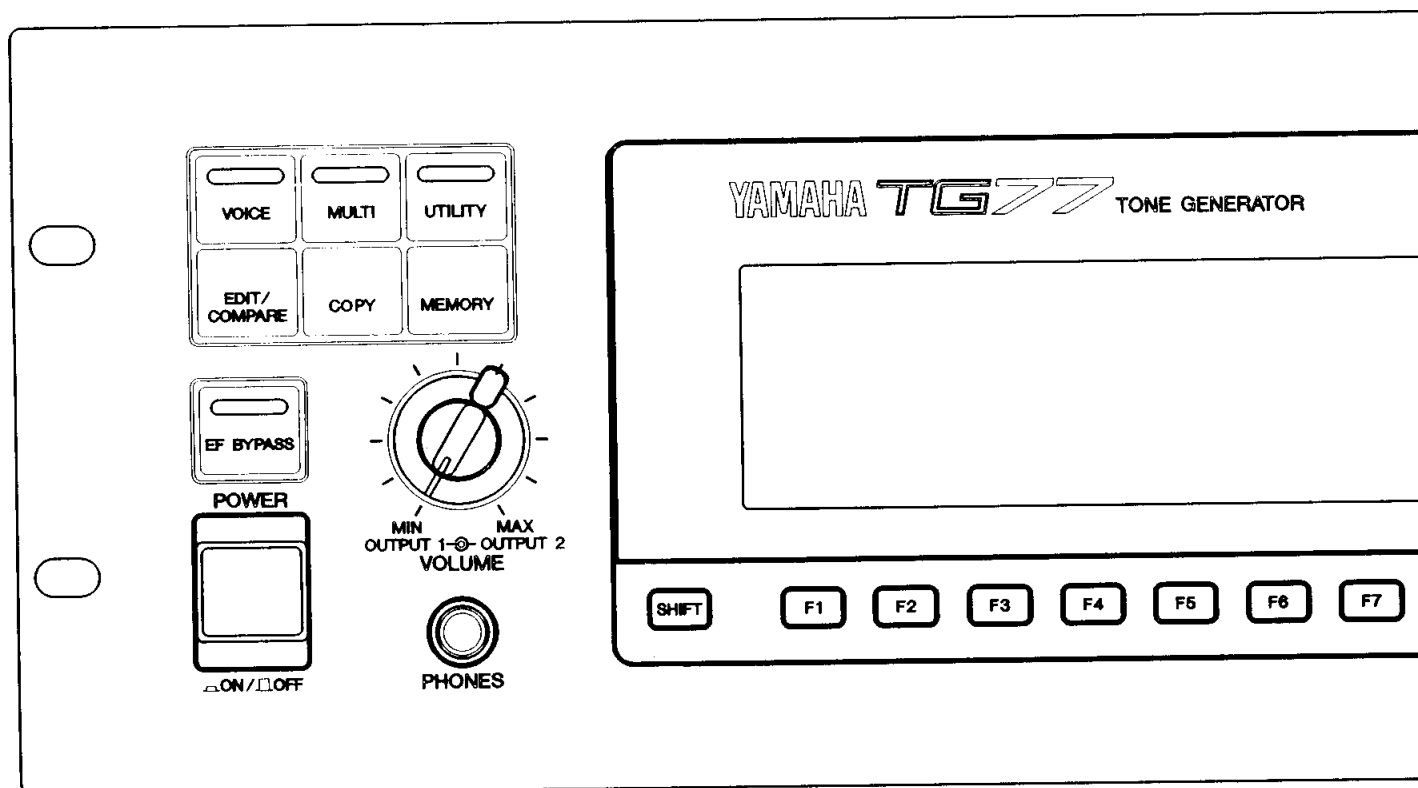

VOICE, MULTI, UTILITY (mode select keys)

The functions of the TG77 are divided into three main modes. Press one of these buttons to select the mode, and the LED above the button will light to indicate the selected mode. The tone generation circuitry of the TG77 is always in one of two modes; Voice mode or Multi mode. One of the LEDs above these two keys will always be lit to indicate the selected mode.

To enter Utility mode, press the UTILITY button and the LED will light. To exit utility mode, press VOICE or MULTI.

EDIT/COMPARE

Press this button to edit the data of the currently selected Voice or Multi. Once you are in edit mode, pressing this button allows you to compare the original data with the edited data. While you are in compare mode, the VOICE or MULTI LED will flash. In compare mode it is not possible to modify parameter values. To return to editing mode, press EDIT/COMPARE once again.

COPY

While editing, this button is used to copy and store various types of data.

MEMORY

To select a preset, internal, or card memory (if a card is inserted), repeatedly press this button until the desired memory is selected. The LCD will show the selected memory.

EF.BYPASS (Effect bypass)

At any time, pressing this button will allow you to hear the sound without the DSP effects. The LED will light to indicate that the effects are bypassed. To defeat effect bypass, press the button again.

POWER switch

The power is on when this switch is pressed. The front panel display will light when the power is turned on.

VOLUME controls

These two concentric rotary controls regulate the output volume from the two pairs of stereo output on the rear panel.

PHONES

A pair of stereo headphones can be connected here to hear the combined stereo sounds of outputs 1 and 2.

Liquid Crystal Display (LCD)

The 240 x 64 pixel LCD is backlit for readability even in dark locations. Adjust the CONTRAST control on the rear panel for best visibility.

SHIFT

When the lower right of the LCD shows an inverse "S" mark, you can press and hold the SHIFT button to make the function keys F1–F8 perform alternate functions. The shifted functions will be displayed in the lower line in place of the regular functions F1–F8.

Pressing the JUMP key while SHIFT is held down will mark the current location.

In Voice Play or Voice Edit mode, pressing the numeric keys 0...9, '-', and SPACE while holding SHIFT will play the notes of the octave. This is useful for checking audio connections, etc.

Function keys F1–F8

In some jobs the bottom line of the LCD will display a function for F1–F8, and pressing a function key will select the corresponding function such as selecting a menu item, moving the cursor, or executing a function. If nine or more functions are available, the lower right of the LCD will show an inverse "S" mark, indicating that you may hold SHIFT and press a function key to access functions 9–16.

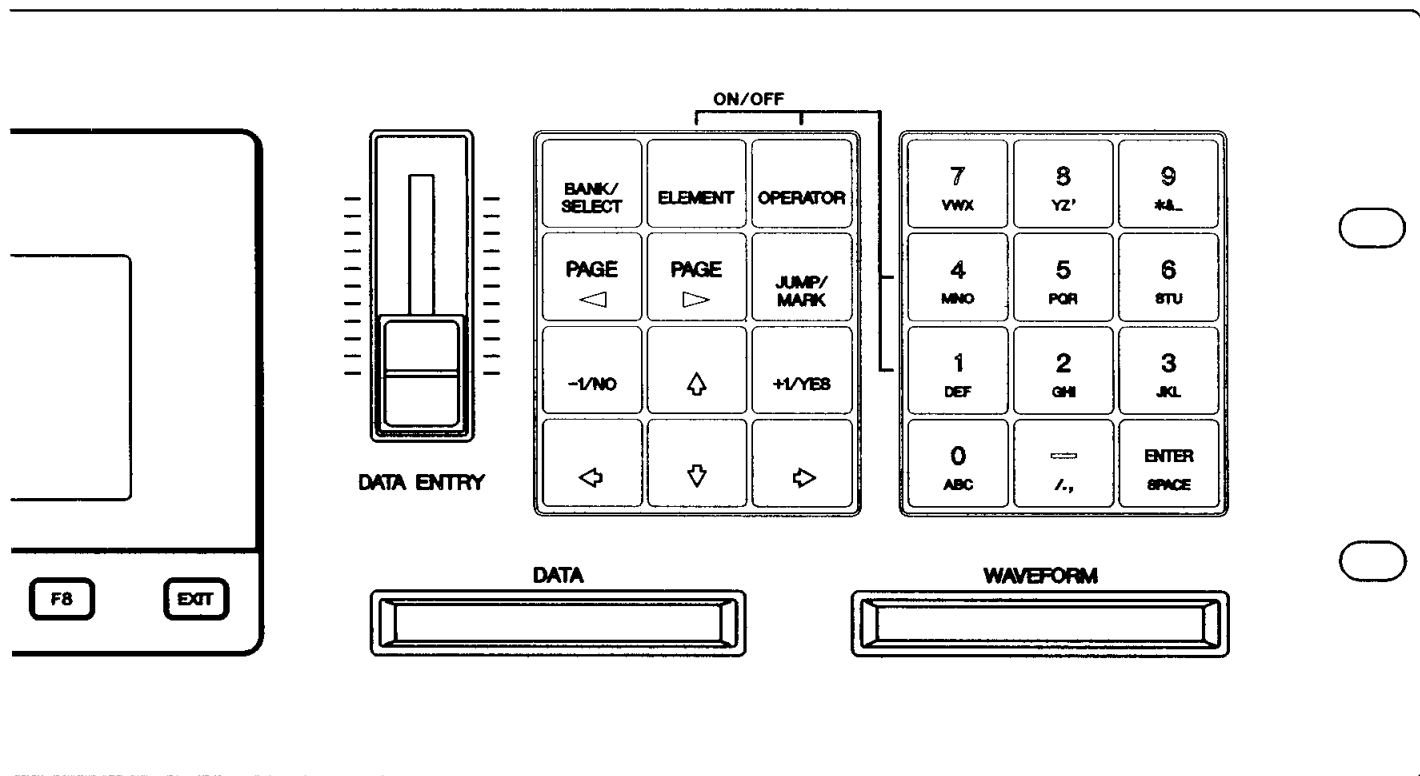

EXIT

Press this key to move back to where you last were before entering the current level; i.e., to move back to the previous branch of the function tree.

DATA ENTRY slider

The DATA ENTRY slider is used to set the data value indicated by the cursor. When you move the slider, the data will immediately change to the value corresponding to the current slider position. Using the slider is convenient when you wish to set the currently selected parameter to a value such as "maximum", or "about 2/3rds", regardless of the actual range of values.

BANK/SELECT

Whenever you are selecting a voice, you can press this button to cycle through the four voice banks A–D. The LCD will indicate the selected bank.

In Voice Edit mode, this button is also to select elements and operators. See ELEMENT and OPERATOR below.

ELEMENT

This button is used in voice edit mode to select and turn on/off elements.

To select an element for editing, hold the BANK/SELECT button and press ELEMENT to cycle through the one, two, or four elements that make up the voice. The currently selected element number and type is displayed after the voice name in all voice editing displays.

To turn off an element, hold ELEMENT and press a numeric key 1–4 to turn off the corresponding element. The on/off status of elements 1–4 is displayed in the top line of all voice editing displays.

OPERATOR

This button is used in voice edit mode to select and turn on/off the operators of an AFM element.

To select an operator for editing, hold the BANK/SELECT button and press OPERATOR to cycle through the six operators in each AFM element. (This works only when the LCD shows the data for a single AFM operator.)

To turn off an operator, hold OPERATOR and press a numeric key 1–6 to turn off the corresponding operator. Whenever you are editing an AFM element, the LCD will indicate the on/off status of the six operators.

PAGE <▶>

These keys move to the next or previous function within the same level; i.e., they move from branch to branch of the tree of functions.

JUMP/MARK

The LCD for most functions in the TG77 has a “system page number”, which is displayed at the upper right of each LCD. If you know the number of the page to which you want to jump; press JUMP, use the numeric key pad to enter the page number, press ENTER, and you will be taken to the specified page.

If you press MARK while holding SHIFT, the current page will be marked. Later when you are in another page and wish to return to the marked page, press JUMP and then ENTER, and you will be taken to the previously marked page. (The page you jumped from will now be marked.)

For details on jumping and marking, see page 26.

-1/+1

The -1/+1 buttons will decrease/increase the current data value in steps of one. If you continue holding down the -1 or +1 key, the value will continue changing. These keys also act as “yes/no” or “on/off” for various functions, and can be used to select voices or multis.

Cursor keys (<▶▶▶▶)

Use these keys to move the cursor in the LCD to select items or data. In some cases, cursor movement will modify parameters or select programs.

Numeric key pad

Use these keys to enter data as an absolute number.

- to select a voice or multi
- after pressing JUMP to specify the page to which you want to jump
- to directly enter a value for the data indicated by the cursor
- to directly select an item from a directory

When specifying a voice name etc., use the numeric key pad to enter the characters printed below each key.

To enter a value, use keys 0–9 to specify the value, press +/- to change the sign if necessary, and press ENTER. For details on using the numeric key pad, see page 30.

DATA card slot

An optional RAM card (MCD64) can be inserted into the DATA slot to store TG77 data.

WAVEFORM card slot

An optional waveform ROM card can be inserted into the WAVEFORM slot to provide additional AWM sounds.

Rear panel

In order to connect the TG77 to other devices (an amp/speaker system, MIDI equipment, footswitches, etc.), you will need to know the names and uses of the various items on the rear panel.

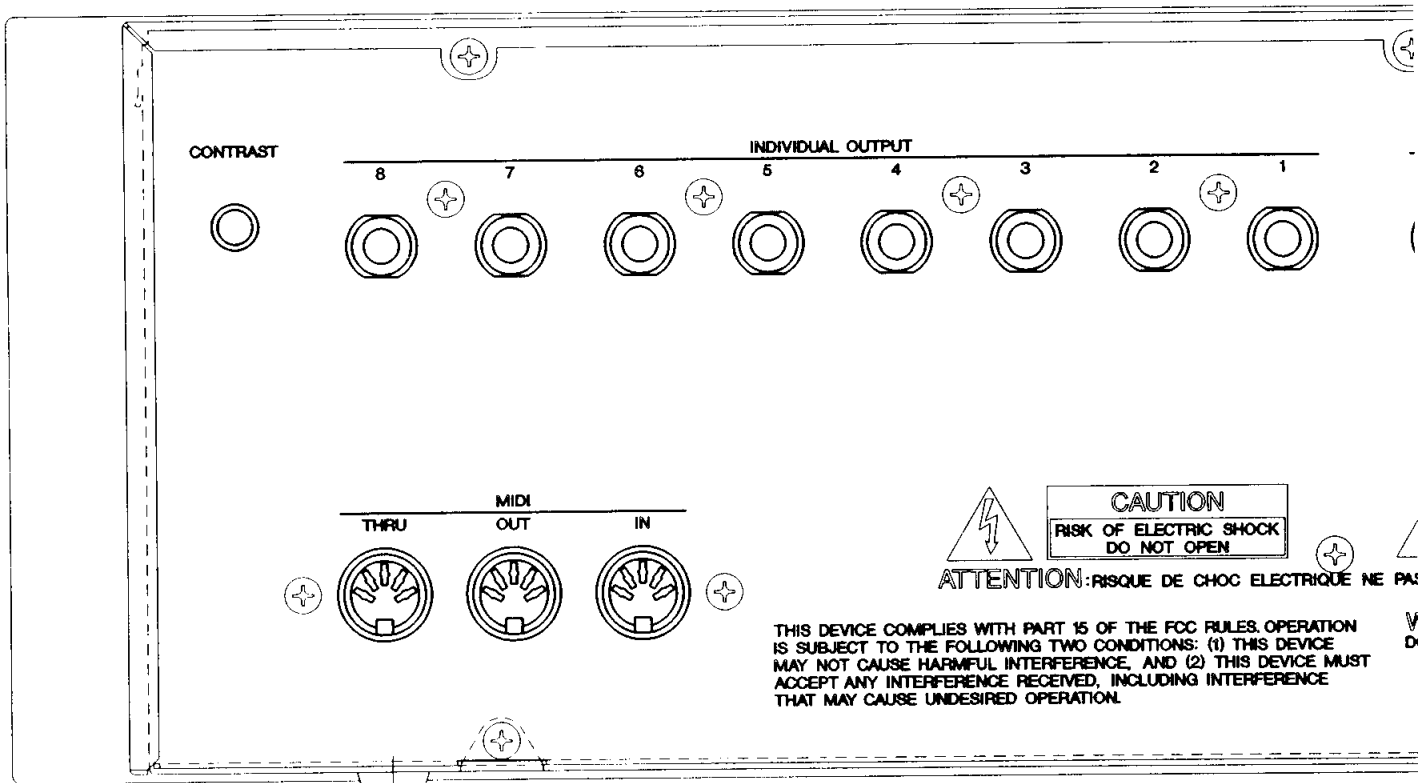

MIDI IN, OUT, THRU

Any MIDI device (sequencer, keyboard, WX7/11 wind controller, G10 guitar controller, etc.) can be connected to MIDI IN to play the sounds of the TG77.

The data received at MIDI IN is re-transmitted unchanged from MIDI THRU. Another MIDI device connected to this terminal will receive the same MIDI data that the TG77 receives.

The data in TG77 memory can be transmitted as a MIDI system exclusive message from MIDI OUT to be received by another TG77 or MIDI storage device.

CONTRAST

This knob adjusts the contrast of the LCD. Adjust it for best visibility. (At extreme settings the display will not be readable.)

OUTPUT 1/1+2 (L/MONO, R)

If the OUTPUT 2 L/R jacks are not plugged in, these jacks will output the combined stereo signal from group 1 and group 2 of the DSP effects system. If the OUTPUT 2 L/R jacks are plugged in, these jacks will output the sound from the group 1 stereo output of the DSP effects system.

If only the L/MONO jack is used, it will carry the combined output of L and R. (Use the L/MONO jack if your mixer/amp system has only one input.)

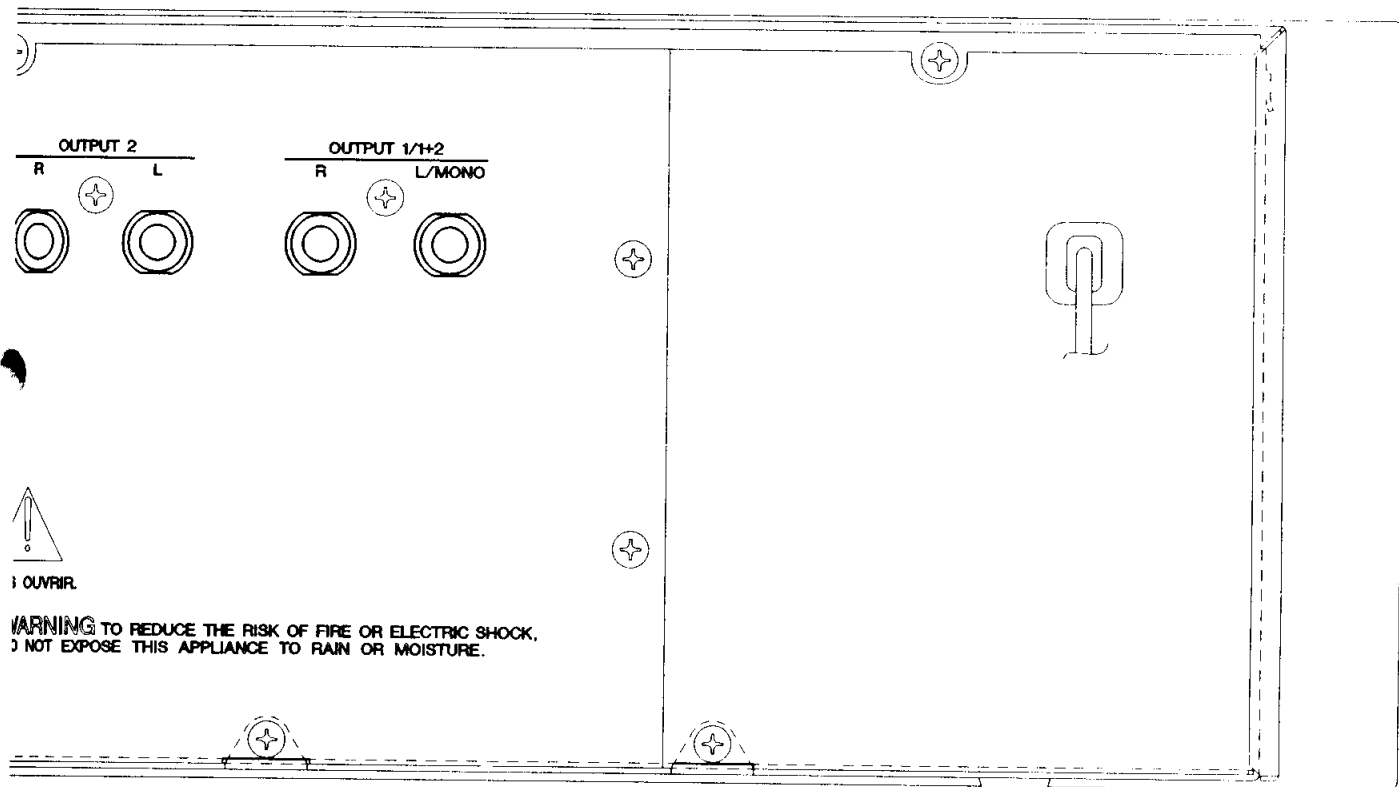

OUTPUT 2 (L, R)

These jacks output the sound from the group 2 stereo output of the DSP effects system. If your mixer/amp system has four or more inputs, using both the OUTPUT 1 and the OUTPUT 2 jacks will allow you to treat the two output groups in different ways, perhaps by panning them to different locations, or processing them through different external effect devices.

INDIVIDUAL OUTPUT 1-8

Each voice (and each channel of a multi) can be assigned to one of the 8 individual outputs. The output is taken from the un-panned un-processed sound of a voice, allowing you to use an external effects device or mixer to add special processing to a specific voice.

It is not possible to output a voice from an individual output and from the stereo outputs at the same time.

Power cable

Plug the power cable into an AC outlet of the correct voltage.

How to move around: job directories

The functions of the TG77 are organized into three main Modes and two editing modes. Some modes have a Job Directory that shows the various Jobs (functions) in the mode. Move to the desired function by selecting a job from the job directory.

Three main modes (1)

The TG77 operates in three main modes. Press one of the three mode select buttons to enter the corresponding mode. (An LED will light to indicate the selected mode.)

Press	to enter	where you can
VOICE	Voice mode	Select and play a Voice.
MULTI	Multi mode	Select and play a Multi.
UTILITY	Utility mode	Make overall settings for the TG77, manage card data, etc.

Play modes and Edit modes (2)

While in voice or multi mode, press EDIT to move to the corresponding edit mode. Voice Edit mode is where you modify the settings that make up a voice, and Multi Edit mode is where you modify the data that makes up a multi. (There is no "utility edit" mode.)

Press	to enter	then press	to enter
VOICE	Voice mode	EDIT	Voice Edit mode
MULTI	Multi mode	EDIT	Multi Edit mode

To leave an edit mode, simply re-select any of the three main modes (or press EXIT from the top level of an edit mode to return to the main mode from which you came).

Select a job from the job directory (3)

Whenever a mode or function is sub-divided into more than one job, there will be a "job directory" that lists the various items or operations. For example, when you enter Multi Edit mode, the following display will appear.

```

MULTI EDIT                                     400
#P-01 Popular Song Tool                        01
1:Voice 05:St-Pan 09:IndOut 13:-----
2:Volume 06:OutSel 10:Assign 14:-----
3:Tuning 07:Effect 11:----- 15:Initlz
4:Shift 08:Name 12:----- 16:Recall
01 02 03 04 05 06 07 08
    
```

This lists the various parameters that can be adjusted in Multi Edit mode; 1.Voice, 2.Volume, 3.Tuning, etc.

To select an item from a job directory, use the arrow keys to move the cursor to the desired item and press ENTER. For example, if from the above display you press ∇ once to move the cursor to "2.Volume" and press ENTER, the following display will appear.

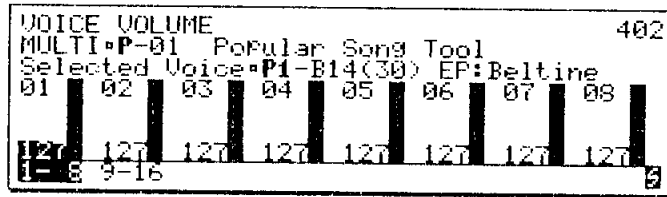

To return to the job directory, press EXIT.

Function keys (4)

Sometimes a job will be divided into two or more screens. For example, "2.Volume" is divided into two jobs; one to set the volume for voices 1-8 and the other to set the volume for voices 9-16. Notice that the bottom line shows "1-8" (above function key F1) and "9-16" (above function key F2). The "1-8" is displayed in inverse video to indicate that the volumes of voices 1-8 can be edited. To edit the volumes of voices 9-16, press function key F2.

Whenever function key assignments are displayed in the bottom line of the LCD, the current selection is indicated in reverse video. Press a function key to move to the desired job.

Move between jobs using <> (page) (5)

Suppose that you wanted to move from the "2.Volume" job to the "3.Tuning" job. You could press EXIT to return to the job directory, and then press 3 and ENTER to move to "3.Tuning", but there is a faster way.

To move between jobs of the same level (i.e., inside the same job directory), use the PAGE <> keys. For example if you are now in the "2.Volume" job, pressing PAGE < would take you to the "1.Voice" job, and pressing PAGE > would take you to the "3.Tuning" job. When moving to a nearby job, this is usually faster than returning to the job directory.

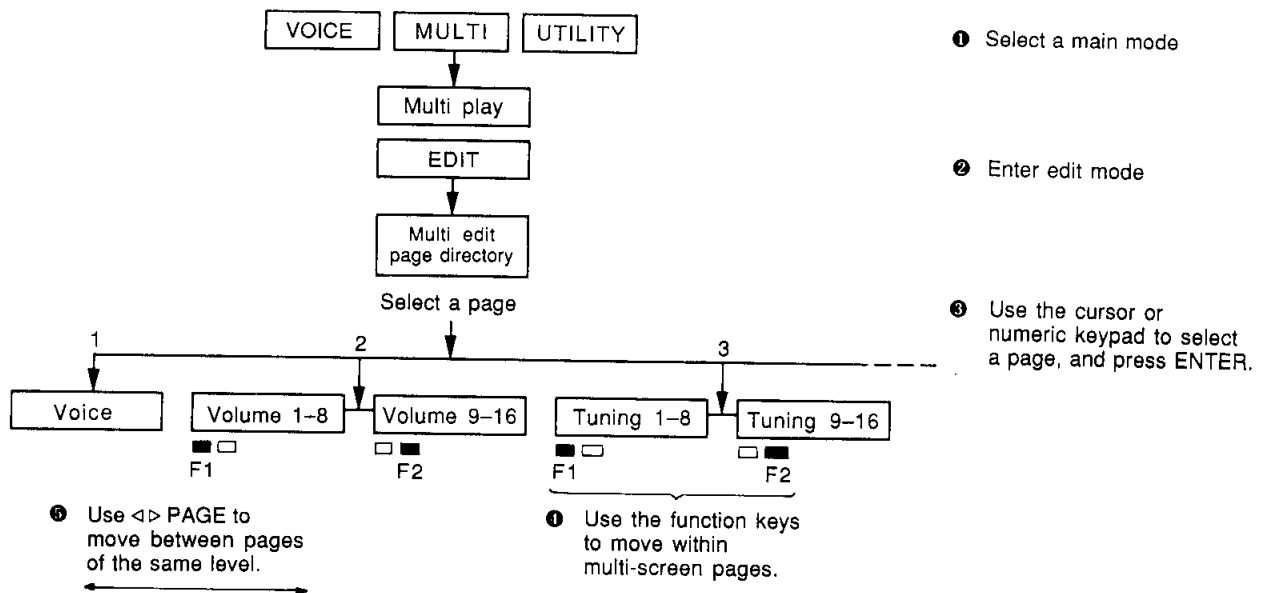

How to move around: the jump function

If you already know the exact function you need to use, it is possible to Jump directly to a specific page number instead of working your way through the job directories. The jump function also allows you to repeatedly jump back and forth between two jobs.

Jump to a specified page number

If you need to move to a distant job, it may sometimes be necessary to press EXIT several times, and then move down through two or more job directories. In such cases, it is much faster to jump directly to a specific page.

You may have noticed that most page displays have a unique three-digit number in the upper right corner. This is the Display Page number. For example, "Multi edit 2. Multi Volume" is JUMP #402. If you frequently need to adjust the settings of this page, remember this page number. Then, no matter where you are, you can press JUMP, 4, 0, 2, and ENTER to jump instantly to that page.

1. Press JUMP.

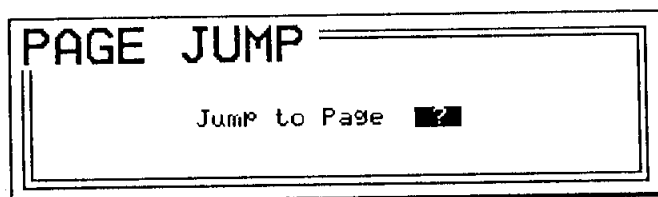

2. Enter the three digit page number.

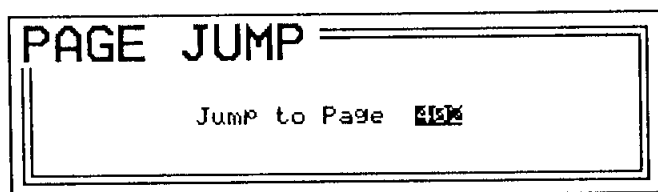

3. Press ENTER and you will jump to the specified page.

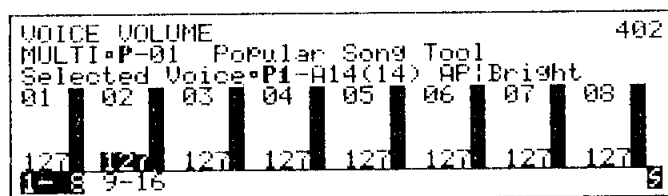

While you are becoming familiar with the TG77 it will probably be easier for you to select the desired page while viewing a page directory. However as you gain more experience, you may find it convenient to use the JUMP key to go directly to frequently-used pages.

Jump between two marked pages

It often happens that you will need to repeatedly make adjustments in two different pages, which may be widely separated. The jump/mark function allows you to jump back and forth between two pages.

Suppose you are editing the tuning of the voices in a multi (*Multi edit*, 3. *Voice tuning*, JUMP #404) and you wish to check the master tuning (*System Utility*, 1. *Master tuning*, JUMP #801).

1. Hold down the SHIFT key and press JUMP. The current page will be marked, and the page number will displayed in inverse with a triangle mark to indicate this.

```

VOICE TUNING                                     7412
MULTI=P-01 Popular Song Tool
Selected Voice=P1-B14(30) EP:Beltline
01 +g | * | 05 + 0 | * |
02 + 0 | * | 06 + 0 | * |
03 + 0 | * | 07 + 0 | * |
04 + 0 | * | 08 + 0 | * |
1-g 9-16 | 5 |

```

2. Then move to the other page, either by jumping to the page number, or by moving through the job directories.

```

MASTER TUNING                                     801

Note Shift = +g
Fine Tuning = + 0

Note Fine

```

3. To return to the previously marked page press JUMP and then ENTER without entering a page number.

```

VOICE TUNING                                     404
MULTI=P-01 Popular Song Tool
Selected Voice=P1-B14(30) EP:Beltline
01 +g | * | 05 + 0 | * |
02 + 0 | * | 06 + 0 | * |
03 + 0 | * | 07 + 0 | * |
04 + 0 | * | 08 + 0 | * |
1-g 9-16 | 5 |

```

4. To jump back to the Master Tuning page, press JUMP and then ENTER again. In this way, pressing JUMP and then ENTER will jump back and forth between the two pages. Each time you jump, the mark is shifted to the page you jumped from. If you return to that page by moving through the modes and job directories in the usual way, you will find that it is marked by the inverted page number and triangle.

Note:

The two pages used in this example are located in two different modes. Whenever you leave multi edit (or voice edit) mode after modifying the data, either by pressing EXIT or by using the Jump function, you will pass through the Auto-Store screen, and must press F6 (Ret) to return to editing mode, F7 (Quit) to quit without storing the changes, or F8 (Go) to store the data.

```

AUTO-STORE MULTI
BP-01 Popular Song Tool
INTERNAL
01
01: POPULE 05: Jazz Q 08: South 13: Pot. Pou
02: Modern 06: Big Ba 10: Folklo 14: IT's Co
03: Funky 07: Beetho 11: Countr 15: PowerP1
04: Ballad 09: Wind E 12: Barock 16: House I
Ret Quit Go

```

If the data has not been modified, this Auto-Store screen will not appear.

How to enter data

To select a voice, adjust a parameter, or give a name to a newly created setting, you will need to enter various types of data into the TG77. The $-1/+1$ keys and data entry slider provide various ways to enter data. Use the data entry method that is most appropriate for each situation. (The following page explains how to use the numeric key pad.)

Select the data to enter

First, use the arrow keys $\triangleleft \triangleright \triangleup \triangledown$ to move the inverse cursor to the data you want to modify.

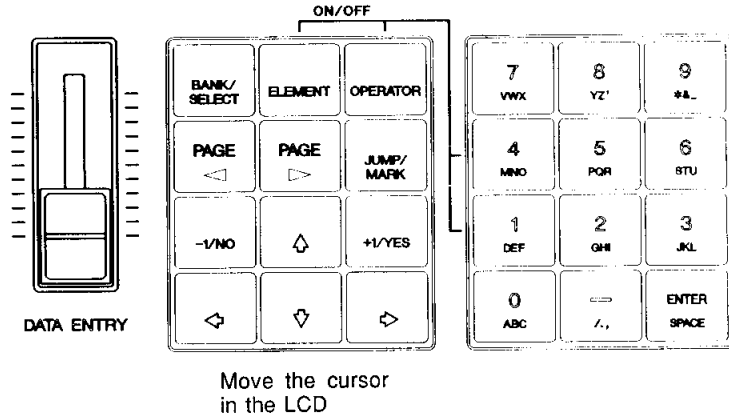

Next you will modify the value using one of the following; $-1/+1$ keys, data entry slider, or the numeric key pad. The method you use will depend on how you want to modify the data.

$-1/+1$ (no/yes)

If you want to decrease or increase the existing data value, use the $-1/+1$ keys. Each time you press the -1 or $+1$ key, the data will decrease or increase one step. This method allows you to move in precise steps, but can take a long time when you need to make a major change in the value.

Some parameters consist of a “off/on” setting, and sometimes you will be asked to reply “no/yes” to a question (such as “do you really want to do this?”). In such cases, press -1 to turn something off or to answer “no”, and press $+1$ to turn something on or to answer “yes”.

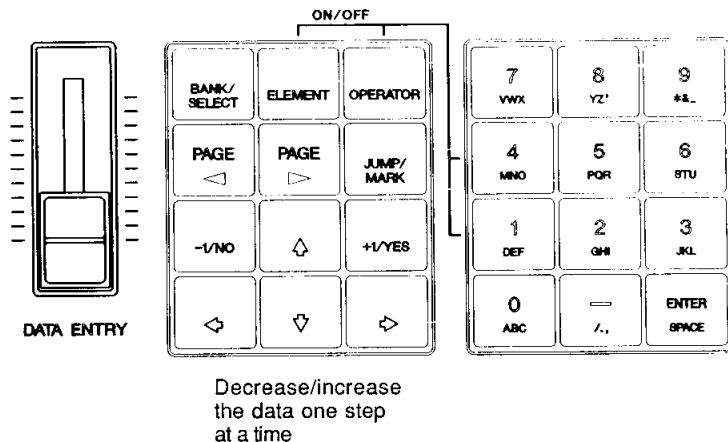

Data entry slider

If you want to set a data value to some setting relative to the entire range of that value (for example “maximum”, “minimum”, or “about 90% of maximum”), use the data entry slider. When you move the slider, the data value is immediately changed to correspond to the position of the slider. The range of the slider will match the range of the parameter value. For example if the parameter being modified has a value range of 0–127, pulling the slider fully down will set a value of 0, and pushing the slider fully up will set a value of 127. Setting the slider exactly in the middle of its range would set a value of 64.

Since the range of the slider always matches the range of the parameter you are adjusting, there is no need to remember the range of the parameter; just move the slider to the position that corresponds to the relative setting you want.

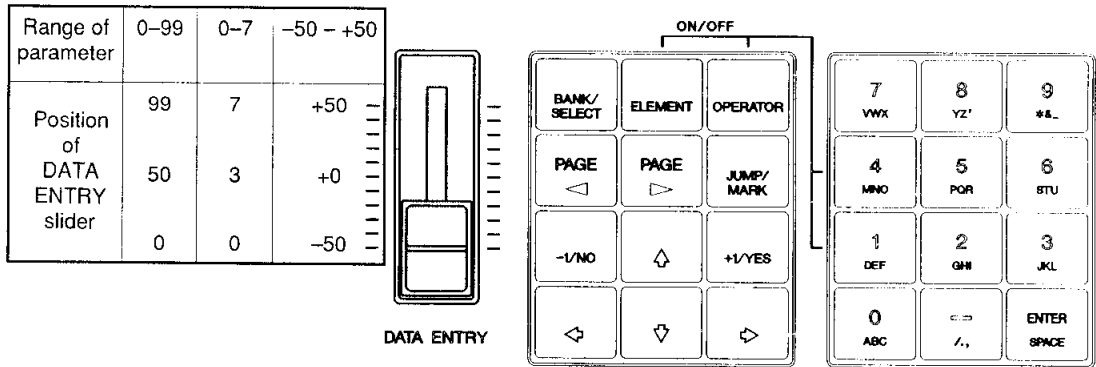

How to use the numeric key pad

The numeric key pad can be used to enter an absolute data value, and also to enter characters for a memory name.

How to enter absolute numerical data

If you want to set a data value to some specific number (for example “57” or “121”), use the numeric key pad. Press one or more keys 0–9 to specify the number, press the – key to change the sign if necessary (when entering a negative number), and press ENTER. For example if you wanted to enter the number “–18”, you would press 1, 8, –, ENTER. Even if the data value has a three-place range (such as 0–127), there is no need to add a zero in front.

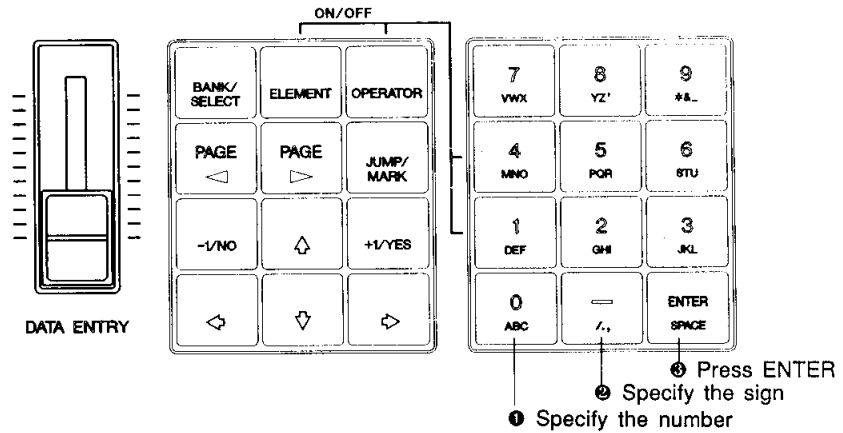

In most displays, the digits you enter from the numeric key pad will be displayed blinking. When you press the ENTER key the number will be finalized.

How to enter character data

You will sometimes need to enter character data to specify a voice name, multi name, etc. When the currently selected parameter requires that you enter character data, the numeric key pad will act in a different way than usual. To try this out, jump to the Voice Name page by pressing the following keys in order; JUMP, 2, 2, 9, ENTER. The following display will appear.

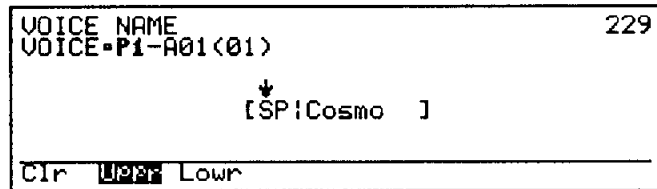

This display is essentially the same as for any other job that requires you to enter character data. Press F1 (Clr) to clear the currently set name, and press F2 (Uppr) or F3 (Lowr) to select uppercase or lowercase letters.

Notice that below the 0 key are printed the characters "A", "B", and "C". Press the 0 key, and the numeral "0" will appear. Press it again for the character "A", again for "B", and again for "C". Press it once more and "0" will reappear. In this way, each time you press a key, the character indicated by the cursor will alternate through the alphabetical characters printed below it and the numeral printed on the key itself. (If you press another of the numeric keys, the cycle will begin from the first character.) Notice that the third press of 8 is an apostrophe, that 9 gives you an asterisk, ampersand, and an underline character, and that - enters a hyphen, slash, period, and comma.

Other characters are available in addition to the characters entered using the numeric key pad. These characters can be selected using the DATA ENTRY slider or the -1 +1 keys. Moving the DATA ENTRY slider will scroll through all available characters in the following order.

(Space) ! " # \$ % & ' () * + , - . / 0 ~ 9 : ;
< = > ? @ A ~ Z [\] ^ _ ` a ~ z { | } ~ (Space.)

Use the <|> keys to move the cursor, and enter characters for the desired name. Pressing the ENTER (space) key will enter a blank and move the cursor to the right.

HOW TO USE MULTI MODE

This section is a step by step explanation of how to use the TG77 in Multi mode to function as up to 16 independent MIDI tone generators. When the TG77 is used in multi mode in conjunction with an external sequencer, it can produce the sounds of a sixteen part ensemble.

Contents of this section	page
Multi edit: initialize a multi and select voices	34
Multi edit: volume, note shift, and panning.....	36
Multi edit: output and effects.....	38
How to name and store your new multi	42
How to edit a voice from inside multi edit mode.....	44

Multi edit: initialize a multi and select voices

When the TG77 is used in Multi mode, it will function as 16 independent synthesizers. This allows each incoming channel of MIDI data to play a different voice.

About this tutorial

In the following pages of this section, we will be explaining the process of creating your own Multi to play from an external MIDI sequencer. We assume that you have an external MIDI sequencer (either a dedicated hardware sequencer such as the QX5FD or QX3, or a software program running on your personal computer), and know how to operate it to record and playback multi-track MIDI sequences.

To keep this tutorial simple, we will assume that your sequencer is transmitting the following four tracks of data: the piano part is being transmitted on channel 1, the bass part on channel 2, the brass part on channel 3, and the drum part on channel 16.

The data in your sequencer

Channel	Contents
1	Piano part
2	Bass part
3	Brass part
...	...
16	Drum part

We will assume that the MIDI OUT of your sequencer is connected to the MIDI IN of the TG77, and that the OUTPUT 1 left and right jacks of the TG77 are connected to a stereo mixer/amp system.

Note when playing a TG77 drum voice

Each note of a drum voice is normally assigned to sound a different instrument. For example in the preset voice P2-D15 Drum 1, the note C3 plays a Crash cymbal. You may need to edit your sequencer data so that appropriate note numbers are being sent to the TG77 drum voice. Page 187 has a table of the instrument/note assignments for the two preset drum voices P2-D15 DR Both and P2-D16 DR Group2. Of course, you can create your own drum voices with different assignments if you wish, to match the rhythm note assignments of your sequence data. Editing a TG77 drum voice is explained on page 148.

Start by initializing a multi

Although it is possible to create a multi by editing one which already exists, in this example we will start from the initialized or "basic" settings. Press MULTI, then press EDIT/COMPARE. While holding SHIFT press F7 (15) to select the Initialize job.

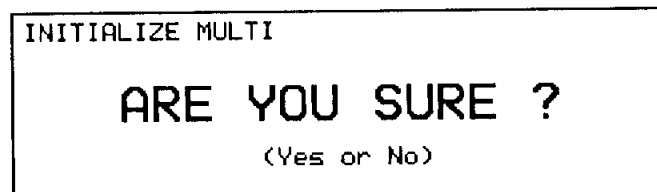

Press +1/YES. The display will show "Completed!". Press EXIT to return to the Multi Edit job directory.

Select a voice for each channel of the multi

Press F1 (01) (or JUMP #401) to get the following display.

```

VOICE SELECT                                401
MULTI P-01  INIT MULTI VOICE
Selected Voice P1-A01(01) SP:Cosmo
05: SP: Cosm 06: SP: Cosm 09: SP: Cosm 13: SP: Cosm
02: SP: Cosm 04: SP: Cosm 10: SP: Cosm 14: SP: Cosm
03: SP: Cosm 07: SP: Cosm 11: SP: Cosm 15: SP: Cosm
01: SP: Cosm 08: SP: Cosm 12: SP: Cosm 16: SP: Cosm
On Off Norm Mon Mode Dir Edit
  
```

Specify the voice that will be played by each channel 1–16 of incoming MIDI data.

1. Move the cursor to the channel for which you want to select a voice.
2. Use the MEMORY button to select a memory; Internal, Preset 1, or Preset 2. (It is not possible for an Internal or Preset multi to use Card voices, nor is it possible for a Card multi to use Internal voices.)
3. Select a voice. You can use the DATA ENTRY slider, the -1 +1 keys, or the numeric keypad to select voices 1–64 of the currently selected voice memory. Or, you can press BANK/SELECT to cycle through banks A–D and use -1 +1 to select voices in that bank.
4. Repeat steps 1–3 to select the following voices for channels 1, 2, 3, and 16 of the multi.

Multi ch. no.	Voice no.	Voice name
1	P1-A16	AP:Grand
2	P1-D13	BA:Woodbas
3	P1-C12	WN:AltoSax
...
16	P2-D16	DR:Group2

5. Select the “off” voice for all other channels, by moving the cursor to the channel selection and pressing F2 (Off), or moving the DATA ENTRY slider to the lowest position.

You can playback your sequencer while editing a multi

From here on, you might want to keep your sequencer running so that you can hear the results as you continue editing the multi. Start your sequencer now, and check that the piano, bass, brass, and drum parts are played by appropriate voices. Don't worry if the pitch range or volume balance is inappropriate. We will be adjusting these in the following pages.

Multi edit: volume, note shift, and panning

Volume, pitch, and many other adjustments can be made independently for each channel of a multi. In addition, you can set each channel either to a static pan position, or specify that the voice selected for a channel use its own pan settings.

Volume settings adjust the level balance

Press EXIT to return to the Multi Edit job directory, and press F2 (02) to move to 2. Volume (JUMP #402). Or you can simply press PAGE▷ to move from 1. Voice to 2. Volume.

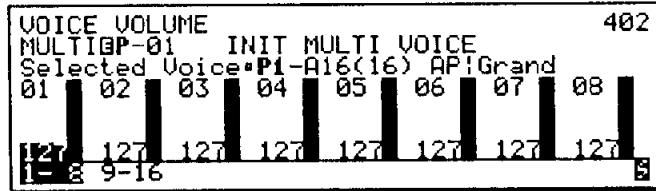

The volumes of each channel are displayed as vertical bar graphs. Move the cursor to the channel whose volume you wish to adjust, and use the DATA ENTRY slider, the -1 +1 keys, or the numeric keypad to set the volume.

The voice number and name of the channel indicated by the cursor is shown in the LCD after "Selected Voice".

The LCD can show the settings for eight channels at a time. To view and adjust the settings for channels 9-16, press F2 (9-16).

Note shift settings adjust transposition

Since the sounds you used when recording your sequence may have been in different pitch ranges than the TG77 sounds you are now playing, it is possible that the pitches are in an inappropriate octave. This can be corrected using the Note Shift parameter.

Press EXIT to return to the Multi Edit job directory, and press F4 (04) to move to 4. Shift (JUMP #406). Or you can simply press PAGE▷ twice to move from 2. Volume to 4. Shift.

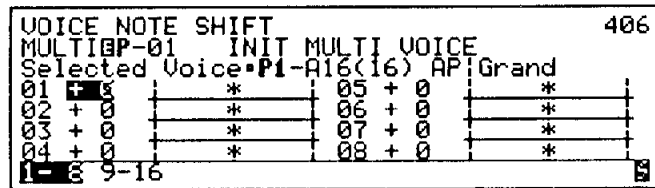

The note shift setting of each channel is displayed as a horizontal bar graph. Move the cursor to the channel whose note shift you wish to adjust, and specify the note shift setting to transpose the pitch over a range of -64...+63 half-steps.

Note:

The multi edit parameter Note Shift has no effect on a drum voice.

Pan settings determine stereo placement

Press EXIT to return to the Multi Edit job directory, and press F5 (05) to move to 5. Static Pan (JUMP #408). Or you can simply press PAGE▷ once to move from 4. Shift to 5. Static Pan.

The static pan setting of each channel is displayed as a horizontal bar graph. Move the cursor to the channel whose static pan setting you wish to adjust, and specify the static pan position over a range of -31...+31 or "VC".

VOICE STATIC PAN				408
MULTI	BP-01	INIT	MULTI	VOICE
Selected Voice • P1-A16(16)				AP: Grand
01	+ 0	*	05	+ 0 *
02	+ 0	*	06	+ 0 *
03	+ 0	*	07	+ 0 *
04	+ 0	*	08	+ 0 *
1-8	9-16			

By selecting "VC" (the selection below -31), you can make the voice selected for this channel of the multi use its own pan settings that have been stored as part of the voice parameters. As explained earlier, each of the one, two, or four elements in a voice has its own panning envelope and other pan settings. If pan settings of a voice are musically important, you should set this multi edit parameter to "VC".

To try this out, move the cursor to channel 16 of the multi. Notice the LCD shows that "P2-D16 DR Group2" is being played by channel 16. Playback the track of your sequencer that is transmitting the drum part on channel 16. Adjust the TG77 static pan for channel 16 over the range of -31...+31 and notice that the entire drum kit is panned to the same location. Now move the DATA ENTRY slider all the way down so that "VC" is selected for channel 16. Notice that each instrument in the drum voice is panned to its own stereo location, as specified in by the parameters for that voice.

VOICE STATIC PAN				409
MULTI	BP-01	INIT	MULTI	VOICE
Selected Voice • P2-D16(64)				DR Group2
09	+ 0	*	13	+ 0 *
10	+ 0	*	14	+ 0 *
11	+ 0	*	15	+ 0 *
12	+ 0	*	16	+ 0 *
1-8	9-16			

When you are finished making pan settings, press EXIT to return to the multi edit job directory.

Multi edit: output and effects

The stereo pan output from each of the 16 voices in a multi can be sent from either or both output groups 1 and 2. These output groups are connected to the two input groups of the TG77's effect system, which contains four DSP effect units.

Select the output group for each channel

The multi edit parameter Output Group Select allows you to assign the stereo output from each of the 16 channels in a multi to either or both output groups 1 and 2. These output groups are connected to the two input groups of the effect system.

From the multi edit job directory, select 06:OutSel (JUMP #410) and press ENTER.

In this example, we will assign channels 1 and 3 (piano and brass) to output group 1 ("grp1"), and channel 2 (Bass) to output group 2 ("grp2"). This will allow us to apply different effects to the piano and brass without affecting the bass (or vice versa).

```
VOICE OUTPUT GROUP SELECT          410
MULTIBP-01  INIT MULTI VOICE
Selected Voice=P1-C12(44) WNIAltoSax
01 Output = grp1    05 Output = both
02 Output = grp2    06 Output = both
03 Output = grp1    07 Output = both
04 Output = both    08 Output = both
1-8 9-16
```

Since channel 16 is using a drum-type voice, its output group selection is determined by the output group selection for each individual note, and cannot be set as a multi edit parameter. (The drum voice selected in this example, P2-D16 DR Group2, assigns all notes to group 2.) For details on editing a drum voice, refer to *Drum set data, 2. Wave data set*, page 148.

Select the effect mode

Press PAGE▷ once to move from 6. Output select to 7. Effect (JUMP #412), and press F1 (01) to select "01.Effect Mode".

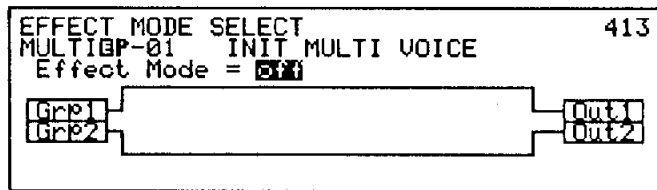

The effect system of the TG77 contains four effect units; two modulation-type units and two reverb-type units. The Effect Mode determines how these four effect units are connected. There are three ways of connecting the effects; modes 1, 2, and 3. You can also select "off" to bypass the effect units. Use the -1/+1 keys to select the various modes 1-3 and note how the LCD graphically indicates the flow from the pan output at left to the final Out1 and Out2 at right.

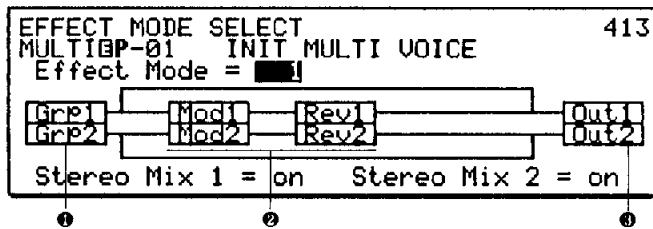

- ① The output from the stereo pan of each voice
- ② is processed through the effects
- ③ and sent out from the rear panel Out1/Out2 jacks.

For this example select effect mode 1.

Select and adjust a reverb effect

Press PAGE > three times to select Reverb Effect 1 Set. This parameter is divided into two jobs. Press F1 (Data), move the cursor to Effect Type, and use the -1 +1 keys to select 01:Rev.Hall.

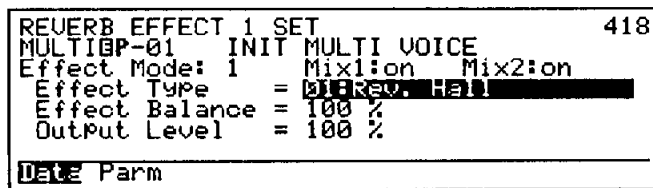

With your sequencer playing back, notice the piano and brass (channels 1 and 3) have a feeling of spacious ambience as if the instruments were being played in a large, reverberant hall. If the effect is not noticeable, move the cursor to Effect Balance or Output Level and set a higher value.

To adjust the parameters of the reverb effect, press F2 (Parm). Move the cursor to Reverb Time and experiment with various settings. Higher settings will make the reverb longer. You can experiment with various settings of the L.P.F. (Low Pass Filter) and Initial Delay as well.

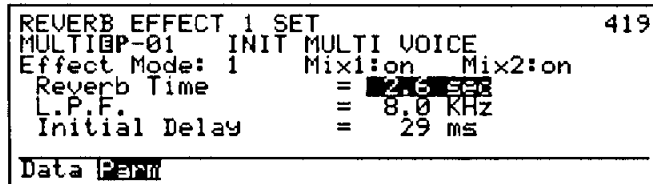

Select and adjust other effect units

If desired, you can use the PAGE < and PAGE > keys to select and adjust the other effect units (Reverb 2, Modulation 1, and Modulation 2).

Bypass the effects to hear the unprocessed sound

Whether or not you are editing the effect, you can press the EF BYPASS button at any time to bypass all effects. When you press EF BYPASS the LED will light, and you can hear the sound without effects. Press it once again, and the LED will go out and effects will be applied once again.

How to use an individual output

In this example, piano and brass (channels 1 and 3) are being processed through Modulation 1 and Reverb 1, while bass and drums (channels 2 and 16) are being processed through Modulation 2 and Reverb 2.

Suppose you wanted to process just the bass through an external effects unit or mixer, and did not wish to have it share reverb settings with the drums.

In order to do this, simply select individual output 1 for channel 2 (the bass) in the Voice Individual Output Select display (JUMP #423).

Note:

If you set the individual output of a channel to any value other than off, that channel will not be output from the stereo outputs 1 and 2.

```
VOICE IND OUTPUT SELECT 423
MULTI P-01 INIT MULTI VOICE
Selected Voice=P1-D13(61) BA:Woodbas
01 Ind.Out = off 05 Ind.Out = off
02 Ind.Out = 1 06 Ind.Out = off
03 Ind.Out = off 07 Ind.Out = off
04 Ind.Out = off 08 Ind.Out = off
1-8 9-16
```

Now connect the rear panel INDIVIDUAL OUTPUT 1 to your external effects device or mixer. The bass will not appear in the effects or stereo output of the TG77, but you can process it externally and use an external mixer to mix it back into the TG77 stereo output.

How to name and store your new multi

These few pages have shown you some of the possibilities when creating your own multi. Now give the edited multi a name and store it for future use.

Enter a 20-character multi name

From the multi edit job directory, select 8:Name.

```
MULTI NAME          422
MULTI BP-01
      ↓
[ INIT MULTI VOICE ]
-----
Clr  Uppr  Lowr
```

Press F1 (Clr) to clear the currently set multi name, and use the numeric keypad to enter a name for your newly created multi. To select uppercase characters press F2 (Uppr). To select lowercase characters press F3 (Lowr). To move the cursor use the <> keys.

For example to enter the multi name "New1", use < to move the cursor to the beginning of the line, and press the following buttons; F2 to select uppercase, 4 three times to enter "N", >, F3 to select lowercase, 1 three times to enter "e", >, 7 three times to enter "w", >, and 1 once to enter "1".

Store the edited multi

When you have finished entering the multi name, press the mode select key MULTI to exit multi edit mode. Since the multi data has been edited, the top line of the display will ask "AUTO-STORE MULTI".

```
AUTO-STORE MULTI
BP-01 New1
INTERNAL
01: Popula 05: Jazz Q 09: South 13: Pot Pou
02: Modern 06: Big Ba 10: Folklo 14: IT's Co
03: Funky 07: Beetho 11: Countr 15: PowerPl
04: Ballad 08: Wind E 12: Raposu 16: House U
Ret. Quit Go
```

The LCD will show the first seven characters of the names of the sixteen multis in the selected memory. Select a memory into which to store your new multi. If a RAM card is selected, you can press the MEMORY key to select internal or card memories. Remember that storing data will overwrite the data that previously occupied that memory.

For example, if you were about to store the multi in internal memory 3 replacing a multi named "Funky", the LCD would appear as follows.

```
AUTO-STORE MULTI
BP-01 New1
INTERNAL
01: Popula 05: Jazz Q 09: South 13: Pot Pou
02: Modern 06: Big Ba 10: Folklo 14: IT's Co
03: Funky 07: Beetho 11: Countr 15: PowerPl
04: Ballad 08: Wind E 12: Raposu 16: House U
Ret. Quit Go
```

The multi will be stored into this memory

Press F8 (Go), and the bottom line will ask "Are you sure ? (Yes or No)". If you are sure you want to store the edited multi, press +1/YES and the bottom line of the LCD will show "Store completed". If you decide not to store, press -1/NO to return to the previous display.

You will then return to multi play mode.

```
MULTI-I-03 300
New1
MD= 1 Mod1:Through Rev1:Rev Room
      Mod2:Through Rev2:Through
Store completed!
```

How to edit a voice from inside multi edit mode

The TG77 allows you to edit one of the voices in a multi while remaining inside multi edit mode. You can leave your sequencer running, and edit a voice while listening to the voice being played in its musical context.

Enter multi edit mode

If you have been following the tutorial of the last few pages, you should now be in multi play mode with your new multi selected. Start your sequencer playing, and press EDIT/COMPARE to enter multi edit mode.

```
MULTI EDIT 400
┌I-03 New1 01
01:Voice 05:St-Pan 09:IndOut 13:-----
02:Volume 06:OutSel 10:Assi9n 14:-----
03:Tuning 07:Effect 11:----- 15:Initlz
04:Shift 08:Name 12:----- 16:Recall
 01 02 03 04 05 06 07 08 S
```

Press F1 (01) to enter the Voice Select display. Use the <>Δ∇ keys to move the cursor to the voice you wish to edit. In this example we will edit the P1-A16 AP:Grand voice that we assigned to channel 1.

```
VOICE SELECT 401
MULTI-I-03 New1
Selected Voice:P1-A16(16) AP:Grand
01:AP:Grand 05:[off] 09:[off] 13:[off]
02:BA:Wood 06:[off] 10:[off] 14:[off]
03:WN:Alto 07:[off] 11:[off] 15:[off]
04:[off] 08:[off] 12:[off] 16:DR:Gru
On Off Norm Mon Mode Dir Edit
```

Edit the selected voice of the multi

Press F8 (Edit) to get the following display.

```
VOICE EDIT 402
┌I-03 New1 E3: - 500
P1-A16(16) AP:Grand E4: -
01:1AFM mono 05:2AFM poly 09:EG:100% 09
02:2AFM mono 06:1AWM poly 10:2AFM&2AWM
03:4AFM mono 07:2AWM poly 11:Drum Set
04:1AFM poly 08:4AWM poly
Mode Com E1 E2
```

The P1-A16 AP:Grand voice in this example uses one AFM element and one AWM element. The main body of the sound is created by the AWM element, and the AFM element is used as reinforcement. As a simple example of voice editing, we will slow down the attack of the AWM element. For a more detailed explanation of voice editing, refer to the following major section, *How to edit a voice*.

Press F4 (E2) to select element 2, which is an AWM element in this voice. Press the ∇ key once to select 02:EG, and press ENTER to get the following display. Press ▷ once to move the cursor to R1.

```

AWM EG                               ELI 558
VOICE=P1-A16(16) AP:Grand (E2/AWM)
Mode = attack [x 1][Se91]
R1=45 L2=63
R2=12 L3=58
R3=13
R4=15
RR=33 RS=-1
x 1 x 2 x 5 x 10 x 20 x 50 << >>

```

While your sequencer continues playing, use the DATA ENTRY slider to gradually decrease the value of R1 from 45 to about 15. Notice that the attack of the piano sound is slower, and somewhat similar to a bowed string instrument.

Name and store the edited voice

Press EXIT and then F2 (Com) to get the voice common data job directory, select 13:Name, and press ENTER.

```

VOICE NAME                             529
VOICEBP1-A16(16)
      ↓
      [AP:Grand ]
-----
Clr Upper Lower

```

Assign a new name like "Slow Piano" to the voice. Then press EXIT twice to exit voice edit mode. Since you have modified the data, the auto-store display will appear.

```

AUTO-STORE VOICE
BP1-A16(16) Slow Piano
INTERNAL Bank A
01:SP:Cosm 05:SP:Aria 09:SP:Padf 13:AP:CP77
02:SP:Metr 06:SP:Sawp 10:SP:Twil 14:AP:Bri9
03:SP:Diam 07:SP:Dark 11:SP:Anna 15:AP:Hamm
04:SP:Scrp 08:SP:Must 12:AP:Jvor 16:AP:Gren
Ret Quit Go

```

Select a memory into which to store your edited voice, and press F8 (Go). The lower line of the display will ask "Are you sure?". Press YES. Your edited voice will be stored, and you will return to the multi edit mode Voice Select display from which you entered voice edit mode.

```

VOICE SELECT                             401
MULTI-I-03 New1
Selected Voice=P1-A16(16) AP:Grand
01:AP:Grand 05:[off] 09:[off] 13:[off]
02:BA:Wood 06:[off] 10:[off] 14:[off]
03:WN:Alto 07:[off] 11:[off] 15:[off]
04:[off] 08:[off] 12:[off] 16:DR:Grou
Store completed!

```

Notice that the original unedited piano voice has returned. If you wish to use the "Slow Piano" voice which you edited and saved, you must select it as shown in the following display.

```

VOICE SELECT                             401
MULTI-I-03 New1
Selected Voice=I -A15(15) Slow Piano
01:Slow P1 05:[off] 09:[off] 13:[off]
02:BA:Wood 06:[off] 10:[off] 14:[off]
03:WN:Alto 07:[off] 11:[off] 15:[off]
04:[off] 08:[off] 12:[off] 16:DR:Grou
On Off Norm Mon Mode Dir Edit

```

Remember to add 300 to the JUMP number when editing a voice in multi edit mode

As we have already mentioned, most of the displays in the TG77 have a display page number, which allows you to use the JUMP/MARK key to jump directly to a desired page without having to work your way through the job directories. The JUMP number is listed at the right of the title for each entry in the reference section beginning on page 81.

If you have entered voice edit mode from voice play mode, the displays will be numbered beginning with #200, as listed in the reference section. For example, the AWM EG parameters will be on display JUMP #258. However if you are editing a voice from inside multi edit mode, the corresponding AWM EG parameters will be on JUMP #558.

Remember to add 300 to the JUMP number when editing a voice from inside multi edit mode.

HOW TO EDIT A VOICE

This section explains how to edit an existing voice or create a new voice from scratch. Although it is possible to enjoy the TG77 just by playing preset voices, we suggest that you take some time to learn how to edit your own voices. It will take a bit of practice to create the sounds you want, but as you become more experienced you will find that creating voices is enjoyable and rewarding.

Contents of this section	page
What is a voice	50
What is an AWM element	52
The basics of FM synthesis.....	54
What is an AFM element	56
The process of voice editing	58
How voice edit mode is organized.....	60
Simple editing: reverb (Effect).....	62
Simple editing: tone (Filter).....	64
Simple editing: vibrato (LFO).....	68
Simple editing: using a controller	70
Simple editing: attack (EG)	72
How to name and store your new voice	74
How to edit a drum voice	76

What is a Voice

Each Normal voice consists of settings for one, two, or four AFM or AWM elements (Element data) and settings which affect the entire voice (Common data). Each Drum voice consists of a different AWM sampled sound for each of the 61 keys over the range C1–C6.

The Voice Mode determines the number of elements

The TG77 contains a 16 note AFM tone generator and a 16 note AWM tone generator. The Voice Mode setting determines how these tone generators are used to create a Voice, and how many elements are used for each note you play. Each voice uses one of these eleven voice modes.

Mode	Element	E1	E2	E3	E4
01	1AFM mono	AFM	—	—	—
02	2AFM mono	AFM	AFM	—	—
03	4AFM mono	AFM	AFM	AFM	AFM
04	1AFM poly	AFM	—	—	—
05	2AFM poly	AFM	AFM	—	—
06	1AWM poly	AWM	—	—	—
07	2AWM poly	AWM	AWM	—	—
08	4AWM poly	AWM	AWM	AWM	AWM
09	1AFM & 1AWM poly	AFM	AWM	—	—
10	2AFM & 2AWM poly	AFM	AFM	AWM	AWM
11	Drum Set	61 AWM waves			

A normal voice uses one, two, or four elements

Voices created using modes 1–10 consist of Common data that affects all elements, and Element data for one, two, or four elements.

Common data includes a complete set of Effect data for the four DSP units, Controller data such as pitch bend and aftertouch assignments, and Other data such as microtuning table selection, random pitch fluctuation, and portamento settings. Common data also contains settings such as element volume level, detune, note shift, note limit, and velocity limit for each element.

Element data includes AFM or AWM data for one, two, or four AFM or AWM elements. The voice mode will determine whether each element uses AFM tone generation or AWM tone generation. Details of AFM and AWM element data are covered separately in the following sections.

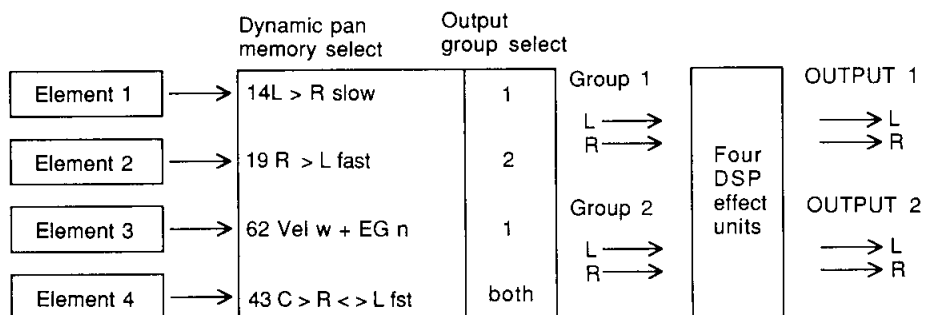

A drum voice uses 61 AWM samples

Voices created using mode 11 will have a different AWM sample assigned to each of the 61 keys over the range C1–C6. Each key also has independent settings for volume, tuning, note shift, pan, etc.

This type of voice is most often used to arrange drums and percussion sounds across the keyboard so that each key will produce a different percussive sound. For example a bass drum might be assigned to C3, a snare to C#3, and a cymbal to D3. Drum voices can be played from a keyboard just like any other voice, but if your sequencer has a “rhythm pattern” track, it may be convenient to use this to play TG77 drum voices. Page 187 has a table of the percussion instrument assignments for each key C1–C6 of the two preset drum voices P2-D15 and P2-D16. Details of how to edit drum voices are given at the end of this section.

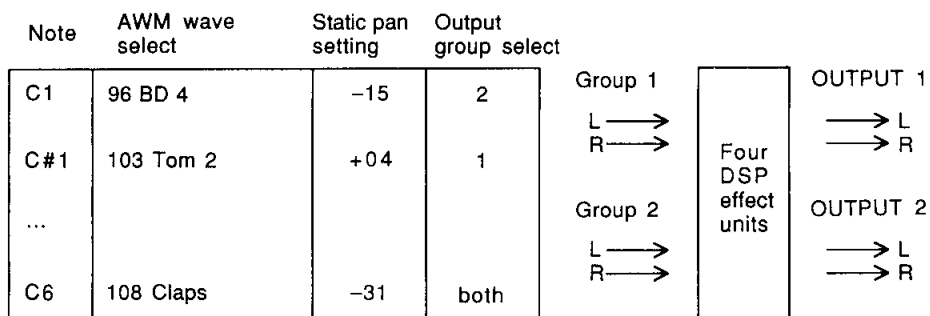

What is an AWM element

An AWM element consists of four main blocks. The Waveform block plays back a sampled sound and determines the pitch, the Filter block modifies the tone, the Amplifier block modifies the volume, and the Pan block moves the sound between left and right outputs. Each block can be controlled in a variety of ways.

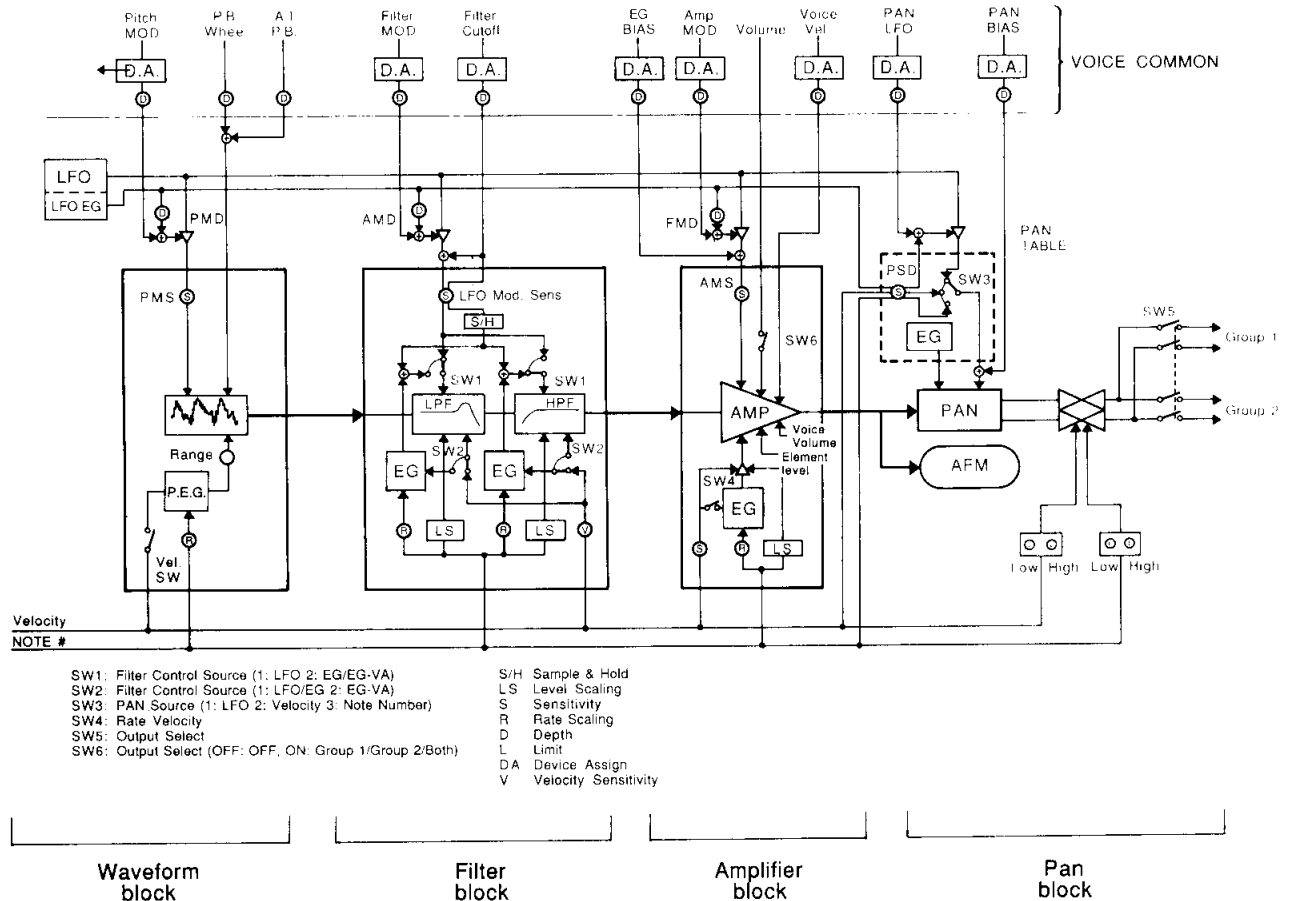

The above diagram shows how the various blocks in an AWM element are related, and how they can be controlled.

Many different ways to control sound

All interesting sounds are constantly changing. For instruments such as piano, the tone and volume of each note changes in a predictable way over time. For other instruments such as violin, the volume, tone, or pitch can be continuously and freely modified by the musician. The TG77 provides several ways to control various aspects of the sound.

- **Envelope Generator (EG):** An EG produces a fixed pattern of change over time. For example to simulate the attack and decay of a piano, you would set the volume EG to be loud when the note is first played and then gradually diminish in volume.

- **Note Number:** The number of the note which is played can be used to affect various aspects of the sound. For example, high notes can be made to decay more rapidly than low notes. Or, low notes can be made to change in pitch, tone, or volume more than high notes.
- **Key Velocity:** The velocity (speed) with which you play each key can affect various aspects of the sound. For example, strongly and softly played notes can differ in pitch, tone, or volume.
- **Low Frequency Oscillator (LFO):** The LFO produces various patterns of cyclical change. Vibrato is the result when the LFO is applied to the waveform block; wah-wah when applied to the filter block; and tremolo when applied to the amplitude block.
- **Controllers:** Controllers on your MIDI keyboard such as the pitch and modulation wheels, aftertouch, and foot controllers can be used to control the sound in various ways. Some controllers such as the pitch bend wheel can directly determine the pitch. Other aspects of the sound can be controlled by the controller you assign. For example if your keyboard is able to transmit Channel Aftertouch messages, you might assign Aftertouch so that the amount of vibrato (LFO modulation to the Waveform block) is increased as you press down on the keyboard.

The waveform block determines the pitch and basic tone

The basic sound of each AWM element is produced by a waveform (a digitally sampled sound). The TG77 contains 112 different waveforms in internal ROM, and an optional waveform card can be inserted into the WAVEFORM slot to provide additional waveforms.

The waveform block can be controlled in various ways to modify the *pitch* of the sound. The pitch EG can be used to give each note a fixed pattern of pitch change, and this pitch change can also be affected by the note number or by key velocity. Vibrato (pitch modulation) can be created using the LFO, and the amount of vibrato can be regulated by a controller. The pitch can be controlled directly using the pitch bend wheel and/or aftertouch.

The filter block modifies the tone

The filter block can be controlled in various ways to modify the *tone* of the sound. Each note can be given a fixed pattern of tonal change by using the filter EG, and this can be also affected by the note number or key velocity. Wah-wah (filter modulation) can be created using the LFO, and wah-wah depth can be regulated by a controller. The tone can also be directly affected by a controller.

The amplifier block modifies the volume

The amplifier block can be controlled in various ways to control the *volume* of the sound. Each note can be given a fixed pattern of volume change by using the amplitude EG, and this can also be affected by the note number or key velocity. Tremolo (volume modulation) can be created using the LFO, and tremolo depth can be regulated by a controller. The volume can also be directly affected by a controller.

The pan block moves the sound

The pan block can be controlled in various ways to move the sound between left and right outputs. Each note can be given a fixed pattern of panning by using the pan EG, and this panning can be further affected by either note number, key velocity, or LFO.

The basics of FM synthesis

FM synthesis is a patented Yamaha method for using Frequency Modulation (FM) to produce complex waveforms that can be controlled in musically useful ways.

Interesting sounds have complex waveforms

The sounds produced by most musical instruments have a very complex waveform, which is constantly changing. We hear these complex waveforms as “interesting” or “acoustic-sounding”.

Electronic instruments use an oscillator to produce a waveform. Unfortunately, electronic oscillators are best at producing simple and repetitive waveforms. These waveforms sound “artificial” or “electronic”, and are not very interesting to listen to. A major concern of electronic musical instrument design is to find a simple way to electronically produce a complex waveform and be able to control it.

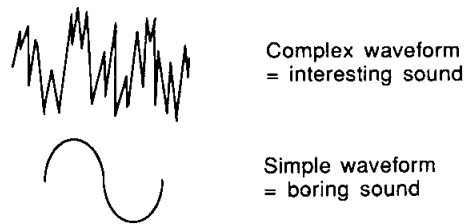

FM is a simple way to make a complex waveform

The advantage of FM synthesis is that waveforms with very complicated harmonic structure can be simply and economically created, and controlled in many different musically useful ways. In FM synthesis, one waveform is used to modulate another waveform. Even if the two original waveforms are simple, the result can be a complex and interesting sound.

In the following diagram, the upper oscillator is called the Modulator and the lower oscillator is called the Carrier. The complexity or brightness of the resulting waveform that we hear will depend on the output level of the Modulator; i.e., as we increase the modulation, the complexity or brightness will increase. Increasing the output level of the Carrier will simply increase the volume.

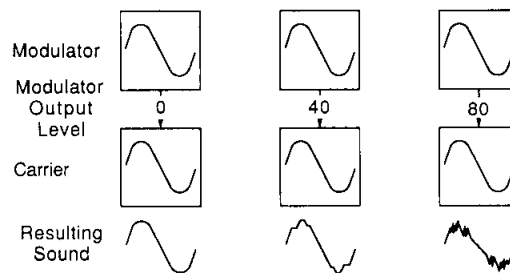

Interesting sounds change over time

Many instruments have a characteristic pattern with which the sound changes as time goes by. This “shape in time” is called the Envelope. The following diagram shows how a piano envelope differs from an organ envelope. A piano begins loud and then gradually diminishes in volume and tonal complexity. An organ however maintains the same volume and tone as long as the key is pressed.

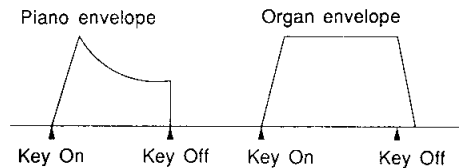

In synthesizers, a device called an Envelope Generator (EG) is used to produce a “shape in time” which can be used to control various aspects of the sound.

An algorithm is an arrangement of six operators

In Yamaha FM synthesizers, each oscillator has its own Envelope Generator (EG) to vary its output level over time. This package of oscillator and EG is called an Operator.

The FM tone generator of the TG77 uses six operators to produce sounds. These six operators can be arranged in 45 different basic Algorithms (patterns or combinations). Each operator acts either as a modulator or carrier depending on its *location* in the algorithm. Only operators that appear at the *bottom* of an algorithm are *carriers*.

For example algorithm 42 uses the six operators as three separate FM pairs; operators 2, 4, and 6 (the modulators) are modulating operators 1, 3, and 5 (the carriers). On the other hand, algorithm 6 has only one carrier; operators 4, 5, and 6 are all modulating operator 3, which is modulating operator 2, which is modulating operator 1.

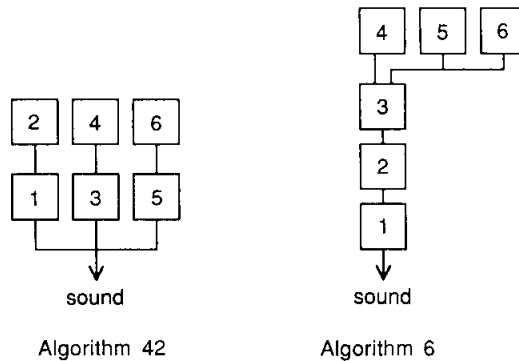

How to change the tone of an FM sound

We have learned that the output level of a modulator operator determines how complex or bright the resulting sound will be. This means that changing the output level of a modulator will affect the tone. The output of the carrier operator is what we actually hear, so changing the output level of a carrier will affect the volume.

Before you begin editing an FM sound, check the algorithm to see how the operators are arranged. Notice which operators are acting as carriers and which are acting as modulators. Then you can adjust the output levels of the various operators to modify the tone or volume.

Each operator has its own EG to vary the operator output level over time. Adjusting the EG of a modulator will modify how the tone will change over time. Adjusting the EG of a carrier will modify how volume will change over time.

What is an AFM element

An AFM element consists of four main blocks. The FM block uses six operators to create a complex sound and determines the pitch and basic tone, the Filter block modifies the tone, the Amplifier block modifies the volume, and the Pan block moves the sound between left and right outputs. Each block can be controlled in a variety of ways.

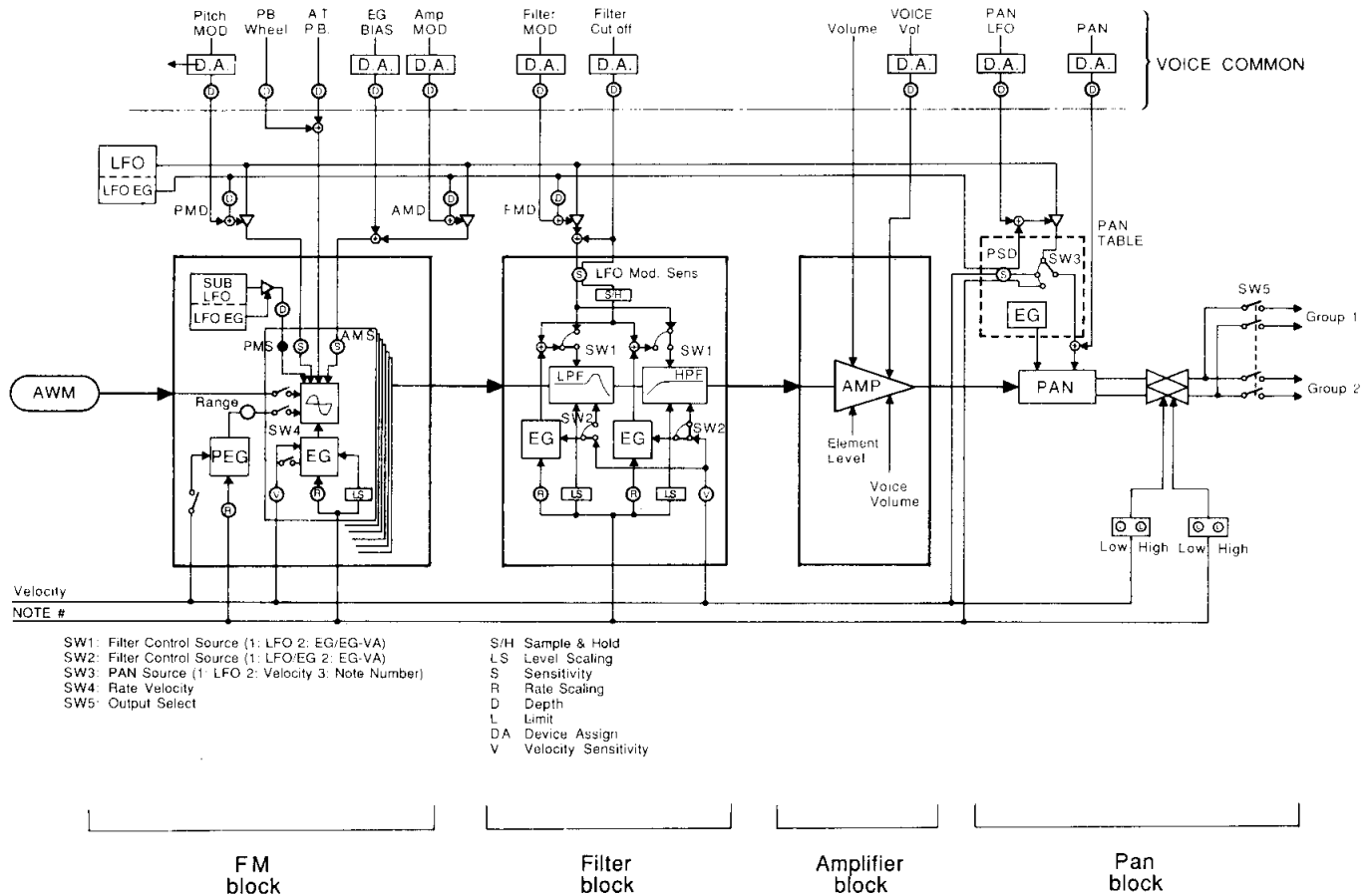

The above diagram shows how the various blocks in an AFM element are related, and how they can be controlled.

Many different ways to control sound

As explained in the previous section “What is an AWM element”, an AFM element can be controlled in various ways using EG, note number, key velocity, LFO, and controllers.

The FM block determines pitch, tone, and volume

The basic sound of each AFM element is produced by six FM operators arranged in an algorithm. The FM block can be controlled in various ways to modify the *pitch*, *tone*, and *volume* of the sound.

- EGs of the six operators determine how the volume and tone will change over time. Each operator EG can also be affected by the note number or key velocity.

- Pitch EG determines how each note will change in pitch over time. This pitch change can also be affected by the note number or by key velocity.
- LFO signal can be used to create vibrato (by modulating operator pitch) or tremolo (by modulating the output level of a carrier operator) or wah-wah (by modulating the output level of a modulator operator). The amount of pitch modulation or amplitude modulation from the main LFO can be regulated by a controller. In addition, the FM block of an AFM element contains a Sub LFO that can be used to modulate the pitch independently of the main LFO.
- The pitch of all operators can be controlled directly using the pitch bend wheel and/or aftertouch of your MIDI keyboard.
- As indicated by the "AWM" in the oval at the far left of the diagram, an AWM digital sample can be used to modulate an FM operator. This is one of the most significant features of the TG77's tone generation system.

The filter block modifies the tone

The filter block can be controlled in various ways to modify the *tone* of the sound. Each note can be given a fixed pattern of tonal change by using the filter EG, and this can be also affected by the note number or key velocity. Wah-wah (filter modulation) can be created using the LFO, and wah-wah depth can be regulated by a MIDI controller. The tone can also be directly affected by a controller.

The filter blocks of AFM and AWM elements are identical.

The amplifier block modifies the volume

The amplifier block can be controlled directly by an assigned controller. Since the change in volume over time of an AFM element is determined by the EGs of carrier operators in the FM block, the amplifier block of an AFM element does not have its own EG.

The pan block moves the sound

The pan block can be controlled in various ways to move the sound between left and right outputs. Each note can be given a fixed pattern of panning by using the pan EG, and this panning can be further affected by either note number, key velocity, or LFO.

The pan blocks of AFM and AWM elements are identical.

The process of voice editing

Editing a voice is a three-step process; select a voice, modify parameters as necessary, and store the edited voice. If you do not store the voice after editing it, the original voice will reappear and your edits will be lost.

1. Select the voice to edit

The first step in the voice editing process is to select the voice you wish to edit. Although it is possible to create a voice starting with the initialized data (a voice where all parameters are set to zero or some basic value), it is usually more efficient to start with a voice that is similar to what you want, and edit it to meet your requirements.

To select a voice, press VOICE to enter voice play mode. The VOICE LED will light. Press MEMORY to select a voice memory; Internal, (Card), Preset 1, or Preset 2. Press BANK/SELECT to select bank A, B, C, or D, and use -1/+1 to select a voice. Or, you can use the numeric keys to directly select a voice 1-64 in the selected memory. The LCD will show the selected voice name.

2. Edit parameters/compare with the original voice

Now that you have selected a voice, press EDIT to edit it. The upper left of the LCD will show "VOICE EDIT". Press the F3 button and then ENTER to select a voice edit parameter. The actual display may be completely different than the following, but don't worry about what the setting actually means. Here we are simply learning the *process* of voice editing. Notice that a small square is displayed between "VOICE" and the voice number. This indicates that the data has not yet been edited.

original data unchanged

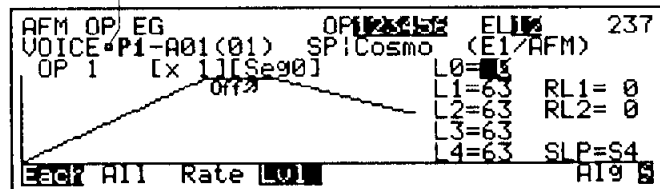

Move the DATA ENTRY slider up and down to modify any parameter that happens to be selected. The voice data has now been edited, and this is indicated by the small square being replaced by an inverse "E".

data has been edited

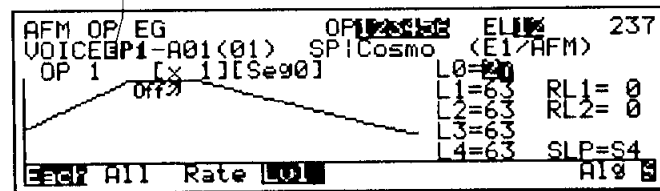

When editing, it is often useful to see and hear the original data you started with. To temporarily bring back the original data, press EDIT/COMPARE. Notice that the VOICE LED blinks, and that a "C" is now displayed, indicating that you are in Compare mode. While in compare mode you can view the various parameters, but will not be able to modify them. To return to edit mode, press EDIT/COMPARE once again.

Compare mode is available in most, but not all editing displays. For details refer to page 87.

3. Store the edited voice

When you have finished editing, you must store the voice if you want to keep it. After you finish editing, exit voice edit mode by pressing EXIT or any mode select key VOICE, MULTI, or UTILITY. If you have edited the voice data in any way, the top line of the display will ask "AUTO-STORE VOICE" ?

```

AUTO-STORE VOICE
BP1-A01(01) SP|Cosmo
INTERNAL Bank A
01: SP|Cosm 05: SP|Aria 08: SP|Padf 13: AP|CP77
02: SP|Metr 06: SP|Sawp 10: SP|Twil 14: AP|Brig
03: SP|Diam 07: SP|Dark 11: SP|Anna 15: SP|Slow Pi
04: SP|Sarp 09: SP|Myst 12: AP|Ivor 16: AP|Gran
Ret Quit Go
  
```

Note:

Voices which use voice mode 3 (4AFM mono), 8 (4AWM poly), and 10 (2AFM&2AWM) occupy extra memory, and can be stored only in bank D. The AUTO-STORE display for such voices will automatically show bank D, and will show "Use bank D" in the bottom line as a reminder.

Voices which use other voice modes can be stored in bank D as well.

The LCD will show the first seven characters of the voicenames in the currently selected bank of voices. The voice name displayed in inverse indicates the voice memory into which the edited data will be stored.

Storing data will overwrite the data that previously occupied that memory, so if you do not want to overwrite the original data, press MEMORY to specify the voice memory, select a bank A–D, and select the voice memory 1–16 in which you want to store your newly edited voice.

Procedure:

When: you exit editing mode and LCD blinks "AUTO-STORE VOICE"

Specify: the memory into which you wish to store the voice.

To return: to edit mode and continue editing without storing, press F6 (Ret).

To quit: editing and return to voice play mode without storing the edited data, press F7 (Quit). You will exit voice edit mode, and the bottom line of the LCD will show "Store cancelled !" until you press another button.

To store: the data press F8 (Go). The bottom line will ask "Are you sure ? (Yes or No)". If you are sure you want to store the edited voice, press +1/YES and the bottom line of the LCD will show "Store completed". If you decide not to store, press -1/NO to return to the previous display.

How voice edit mode is organized

The parameters of a voice are organized into two or more Job Directories, depending on the voice mode. Each job directory lists several groups of parameters. Select a job from the job directory, and edit the parameters in each job.

Normal voice

If a voice mode of 1–10 is selected, the voice will consist of 1, 2, or 4 elements. Each element will be either an AFM element or an AWM element, depending on the selected voice mode.

Voice parameters will be organized into the following job directories. Press a function key F1–F6 to see the job directories, and select the job you want to edit.

F1 (Mode)	F2 (Com)	F3 (E1)	F4 (E2)	F5 (E3)	F6 (E4)
Specify the Voice Mode	Common data edit job directory	AFM element edit job directory	OR	AWM element edit job directory	
1. 1AFM mono 2. 2AFM mono 3. 4AFM mono 4. 1AFM poly 5. 2AFM poly 6. 1AWM poly 7. 2AWM poly 8. 4AWM poly 9. 1AFM&1AWM poly 10. 2AFM&2AWM poly 11. Drum set	1. Element level 2. Element detune 3. Element note shift 4. Element note limit 5. Element velocity limit 6. Element dynamic pan 7. Output select 8. Random pitch 9. Portamento 10. Effect set 11. Micro tuning set 12. Controller set 13. Voice name 14. Individual output select 15. Initialize voice 16. Recall voice	1. Algorithm 2. Oscillator 3. AFM EG 4. AFM operator output 5. AFM sensitivity 6. AFM LFO 7. AFM pitch EG 8. AFM filter ... 15. Initialize AFM element 16. Recall AFM element		1. AWM waveform set 2. AWM EG 3. AWM output 4. AWM sensitivity 5. AWM LFO 6. AWM pitch EG 7. AWM filter ... 15. Initialize AWM element 16. Recall AWM element	

Drum voice

If voice mode 11 has been selected, the voice will consist of 61 AWM digital samples, with a sample assigned to each key of the 61 notes C1–C6. Voice parameters will be organized into the following job directories. Press a function key F1–F2 to see the job directories, and select the job you want to edit.

F1 (Mode)	F2 (Com)
Specify the Voice Mode	Drum Set edit job directory
1. 1AFM mono 2. 2AFM mono 3. 4AFM mono 4. 1AFM poly 5. 2AFM poly 6. 1AWM poly 7. 2AWM poly 8. 4AWM poly 9. 1AFM&1AWM poly 10. 2AFM&2AWM poly 11. Drum set	1. Voice volume 2. Wave data set 3. Effect set 4. Controller set 5. Name ... 7. Initialize 8. Recall

How to select a job

Suppose that you are editing a normal voice and want to edit the Note Shift settings for each element. Press F2 to select the Voice Common data job directory.

```

VOICE EDIT  E1:AFM E3: - 201
            E2:AWM E4: -
-P1-A01(01) SP:Cosmo 01
01:Elem01 05:UlLimit 08:Porta 13:Name
02:ElemDtn 06:ElemPan 10:Effect 14:IndOut
03:NtShift 07:OutSel 11:Mcrtune 15:Initlz
04:NtLimit 09:Random 12:Ctrl1r 16:Recall
Mode Com E1 E2
    
```

Notice that the note shift parameter is job 03. Use the cursor keys or press 0 then 3 on the numeric key pad to move the inverse cursor to "03.NtShift". Then press ENTER and you will enter the Element Note Shift job.

```

ELEMENT NOTE SHIFT  E1:  204
VOICE-P1-A01(01) SP:Cosmo
Element1 AFM = +5  |-----*-----|
Element2 AWM = +24 |-----*-----|
E1 E2
    
```

To return to the job directory, press EXIT.

You can use the <> (PAGE) keys to move to other jobs in the same directory. For example from the note shift job, pressing < would take you to job 02.Element Detune, and pressing > would take you to job 04.Note Limit.

Simple editing: reverb (Effect)

The DSP effect unit adds chorus, echo, reverb, and other effects of spatial ambience. Adjusting the effect is an easy way to change the overall character of a voice.

Select a voice and enter edit mode

Press VOICE and select a voice. So that it will be easy to hear the result of this editing example (and the editing examples in the following sections), select any bright, sustained voice.

Press EDIT to enter voice edit mode. Press F2 to select the voice edit Common data job directory, and press 1 then 0 or use the arrow keys to select "10.Effect". Press ENTER and the Effect parameter job directory will appear.

```

EFFECT SET                               ELI  211
VOICE=P1-A01(01) SP:Cosmo
01:Effect Mode Select                      01
02:Modulation Effect 1 Set
03:Modulation Effect 2 Set
04:Reverb Effect 1 Set
05:Reverb Effect 2 Set
01  02  03  04  05
    
```

First we will be selecting the Effect Mode. Press F1 to select "01.Effect Mode".

Select one of three effect modes

The TG77 contains four DSP effects; two modulation-type effects (Mod1 and Mod2) and two reverb-type effects (Rev1 and Rev2). The Effect Mode determines how these four effects are connected. There are three ways of connecting the effects; modes 1, 2, and 3. You can also turn the effect mode Off to bypass the effect units. Use the -/+ keys to select the various modes 1-3 and note how the LCD graphically indicates the flow from the pan output at left to the final Out1 and Out2 at right.

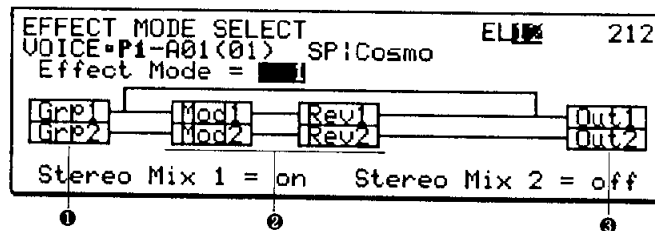

- ① The stereo sound from the voice pan ② is processed through the effects
- ③ and sent out from the rear panel Out1/Out2 jacks.

For this example select effect mode 1.

Select and adjust a modulation effect

Press the PAGE > button to move to Modulation Effect 1 Set. This parameter is divided into two jobs. Press F1 (Data) and move the cursor to Effect Type. Use the -/+ keys to select 02.St.Flange (stereo flanging).

```

MODULATION EFFECT 1 SET                 ELI  213
VOICE=P1-A01(01) SP:Cosmo
Effect Mode: 1    Mix1:on    Mix2:off
Effect Type = 02:St.Flange
Effect Balance = 100 %
Output Level = 100 %
    
```

DATE Parm

Play the keyboard and notice the swirling or swishing effect. If the effect is not noticeable, move the cursor to Effect Balance or Output Level and set a higher value.

To adjust the parameters of the modulation effect, press F2 (Parm). Move the cursor to Mod.Frequency and use the -1/+1 keys to increase or decrease the speed of modulation while playing the keyboard to hear the result. You can experiment with various settings of the Mod.Depth, Mod.Delay, and Feedback Gain settings as well.

```

MODULATION EFFECT 1 SET      ELI  214
VOICEBP1-A01(01)  SP:Cosmo
Effect Mode: 1      Mix1:on  Mix2:off
Mod. Frequency     =  0.8 Hz
Mod. Depth         =  60 %
Mod. Delay         =  1.4 ms
Feedback Gain      =  35 %
Data Parm
  
```

Select and adjust a reverb effect

Press PAGE > twice to select Reverb Effect 1 Set. This parameter is also divided into two jobs. Press F1 (Data), move the cursor to Effect Type, and select 01:Rev.Hall.

```

REVERB EFFECT 1 SET      ELI  217
VOICEBP1-A01(01)  SP:Cosmo
Effect Mode: 1      Mix1:on  Mix2:off
Effect Type        =  01:REV. HALL
Effect Balance     =  32 %
Output Level       =  100 %
Data Parm
  
```

Play the keyboard and notice the feeling of spacious ambience as if the instrument were being played in a large, reverberant hall. If the effect is not noticeable, move the cursor to Effect Balance or Output Level and set a higher value.

To adjust the parameters of the reverb effect, press F2 (Parm). Move the cursor to Reverb Time and experiment with various settings. Higher settings will make the reverb longer. You can experiment with various settings of the L.P.F. (Low Pass Filter) and Initial Delay as well.

```

REVERB EFFECT 1 SET      ELI  218
VOICEBP1-A01(01)  SP:Cosmo
Effect Mode: 1      Mix1:on  Mix2:off
Reverb Time        =  3.4 sec
L.P.F.             =  9.0 KHz
Initial Delay      =  41 ms
Data Parm
  
```

When finished, press EXIT twice to return to the voice edit Common data job directory.

Bypass the effect to hear the unprocessed sound

Whether or not you are editing the effect, you can press the EF BYPASS button at any time to bypass the effect. When you press EF BYPASS the LED will light, and you can hear the sound without the effect. Press it once again, and the LED will go out and the effect will be applied once again.

Simple editing: tone (Filter)

Each element in a voice has two filters which can be used to make overall adjustments in tone. A filter can be controlled in various ways. Controlling a filter by key-on velocity is a simple way to make a voice respond expressively to your keyboard playing.

What is a filter

In electronic musical instruments, a filter removes a specified range of frequencies from the sound, and allows the rest to pass through. For example if the high frequencies are removed and the low frequencies allowed to pass through, the sound will be made darker. This type of filter is called a Low Pass Filter (LPF). The frequency at which the filter begins to affect the sound is called the Cutoff Frequency.

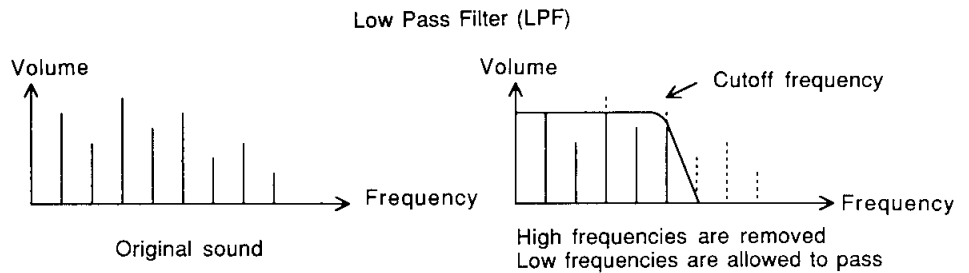

Each of the one, two, or four elements in a normal voice contains two filters, which can be controlled independently. One filter is fixed as a Low Pass Filter (LPF). The other filter can be used either as a LPF or as a High Pass Filter (HPF); i.e., a filter that allows only high frequencies to pass, resulting in a thinner tone.

Turn off unwanted elements

Each normal voice consists of one, two, or four elements, and each element has its own set of two filters. If the voice you are editing contains two or four elements, it may be helpful to listen to only one element as you adjust its filters. To the right of the voice name displayed in the voice edit job directory is a list of the elements used by the currently selected voice.

This voice uses two elements

```
VOICE EDIT E1:HPF E3: - 201
           E2:LPF E4: -
BP1-A01(01) SP:Cosmo 10
01:ElemLvl 05:Ullimit 09:Porta 13:Name
02:ElemDtn 06:ElemPan 10:Effect 14:IndOut
03:NtShift 07:OutSel 11:MorTune 15:Initlz
04:NtLimit 08:Random 12:Cntllr 16:Recall
Mode Com E1 E2
```

The voice selected in the above display uses two elements. Hold down the ELEMENT key and press numeric key 2 to turn off element 2. Now you will hear only element 1. Repeat the same procedure to turn the element back on again. You can turn each element on/off at any time while editing.

Specify the type of filter and the cutoff frequency

Press F3 to select the voice edit Element 1 job directory, select 08:Filter, and press ENTER.

Filter parameters are divided into three jobs. Press F1 to select 01:Cutoff Frequency.

CUTOFF FREQUENCY		OF 123456	ELIF	249
VOICEBP1-A01(01)		SP: Cosmo (E1/AFM)		
Filter1	LPF	9.510kHz (110)	LFO	
Filter2	LPF	9.510kHz (110)	LFO	
Resonance = 0		Velocity Sens = +7	LFO Cutoff Sens = +3	
				Alt

Set both filters 1 and 2 to LPF and 9.510 kHz, and set Velocity Sens = +7. Play notes on your MIDI keyboard, softly and then strongly. (Be sure that your keyboard is set to be sensitive to key-on velocity.) Notice that as the keyboard is played more strongly, the tone is brighter. This is because the velocity sensitivity setting of +7 allows the key velocity to increase the cutoff frequency of the filter.

Increasing the Resonance setting will boost the frequencies at the cutoff point, making the effect of the filter more noticeable.

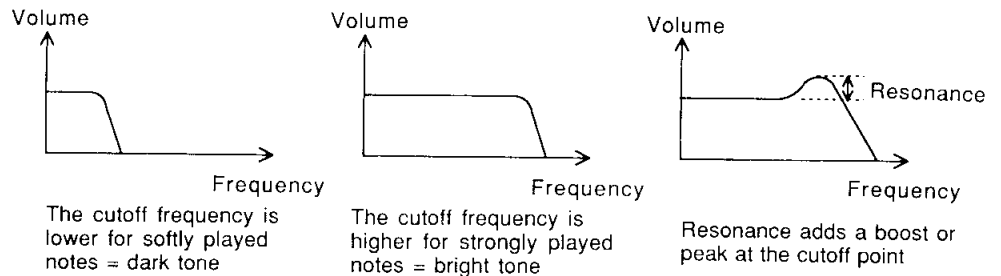

Other ways to control the filter

The TG77 provides many ways to control the filter in addition to key velocity.

EG: Each of the two filters has its own independent EG, which can be used to give each note a fixed pattern of tonal change, such as the characteristic "whaaa" of a brass instrument.

Note Number: The note number can affect the rate at which each filter EG changes the tone, and/or affect the width of the change in tone. For example high notes can be made to change in tone more rapidly than low notes, or low notes can be made to change in tone more greatly than high notes.

Key velocity: Key velocity can be used to affect the amount of tonal change produced by each filter EG. For example strongly played notes can be made to have a greater change in tone.

LFO: Wah-wah (cyclical tone change) occurs when the LFO is applied to the filter block.

Controllers: A specified controller (such as modulation wheel or foot controller) can be used to adjust the depth of the wah-wah (Filter Modulation) caused by the LFO.

For example if you have a modulation wheel on your MIDI keyboard that transmits MIDI Control Change number 001, and wish to use it to control the TG77's filter cutoff, make the following settings.

1. go to Voice Common job 12. Controller set (JUMP #228) and press F4 (Other).
2. select 001 Modulation as the MIDI controller for Cutoff Depth, and set the Value to the amount of control you wish
3. go to element filter page (for an AFM element JUMP #249, for an AWM element JUMP #265) and set Ctrl to "LFO" for one or both filters
4. in the same page, set the LFO Cutoff Sens for the amount of control you wish

5. If the LFO has already been assigned to affect filter cutoff, you may wish to decrease the LFO F.Mod Depth (for an AFM element JUMP #224, for an AWM element JUMP #261).

Or, a device can be used to adjust the offset of the entire filter EG. For details refer to *Ctrl=EG* and *Ctrl=EG-VA* in *8.1 Cutoff Frequency*, page 131.

Simple editing: vibrato (LFO)

The LFO produces a cyclicly repeating pattern of change. Vibrato is created by applying the LFO to the pitch.

What is an LFO

A Low Frequency Oscillator (LFO) is a device that produces a waveform at a slow speed (low frequency). This slowly repeating waveform can be applied to various aspects of the sound to cause cyclicly repeating patterns of change. When the LFO is applied to the pitch, vibrato is the result. When the LFO is applied to the filter, wah-wah is the result. When the LFO is applied to the volume, tremolo is the result.

Adjust the LFO

In this example we will use the LFO to add vibrato to the sound. Move to the Voice Edit job directory, and press F3 to get the Element 1 job directory. If element 1 is AWM, select job 05:LFO. If element 1 is AFM, select job 06:LFO and press F1 to select the Main LFO.

```
AFM LFO                               OF:12652  ELI 244
VOICEBP1-A01(01) SP:Cosmo (E1/AFM)
Main LFO
Wave = Triangle A Mod Depth = 0
      ^~         P Mod Depth = 20
Speed = 66       F Mod Depth = 0
Delay = 20       Init Phase = 0
Main Sub                               A19
```

The Main LFOs of AWM and AFM elements are the same. (AFM elements have a Sub LFO which we will not be using in this example.)

Increase the P Mod Depth setting (Pitch Modulation Depth) while playing a note, and you will hear vibrato. If you do not hear any change when you increase the LFO P Mod Depth, you may need to increase the Pitch Modulation Sensitivity (PMS) as explained in the last two paragraphs below.

Other LFO parameters — Speed and Wave

To regulate the speed of vibrato, move the cursor to Speed and adjust the value over a range of 0–99. Extremely high settings will result in a buzzing sound, and extremely low settings will result in a very slow pitch change.

To modify the shape of the vibrato, move the cursor to Wave and select a different LFO waveform. The selected LFO waveform will be graphically shown in the line below.

Before you proceed to the next section of this example, set P Mod Depth to 0.

Increase the modulation sensitivity for a AWM element

Press EXIT to return to the Element 1 job directory, and select 04:Sensitiv (sensitivity).

```
AWM SENSITIVITY                       ELI 260
VOICEBP1-A01(01) SP:Cosmo (E2/AWM)
Velocity Sens = 5
Rate Vel Switch = on
Amp Mod Sens = +0
Pitch Mod Sens = 4
KUS Rate AMS PMS
```

Pitch Mod Sense (pitch modulation sensitivity) determines how sensitive the pitch will be to modulation from the LFO. Increase the Pitch Mod Sense until you hear vibrato.

Increase the modulation sensitivity for a AFM element

Press EXIT to return to the Element 1 job directory and select 05:Sensitiv (sensitivity).

AFM SENSITIVITY		OP1	OP2	OP3	OP4	OP5	OP6
VOICE	P1-A01(01)						
Velocity		+2	+0	+2	+0	+2	+0
Rate Vel		off	off	off	off	off	off
AModSens		0	0	0	0	0	0
PModSens		1	0	0	3	3	1
Rate	AMS		PMS				AI9

PModSens (pitch modulation sensitivity) is adjustable independently for each operator over a range of 0–7. To create normal vibrato, all operators must be pitch modulated equally by the LFO. Increase the PModSens equally for all operators. (If the LFO affects the pitch of some operators more than others, the harmonic structure of the sound will cyclicly change, which can be an interesting effect in its own right.)

Simple editing: using a controller

Many acoustic instruments allow the musician to modify the volume, tone, or pitch while a note is being played. The controllers on your MIDI keyboard can be used to continuously affect various aspects of the sound for musically expressive control.

Control makes musical expressiveness possible

On instruments such as piano or organ, there is little that the musician can do to modify the sound once the note has been struck. However on instruments such as wind, brass, or strings, the volume, tone, or pitch can be continuously and freely modified even while sound is being produced. The controllers on your MIDI keyboard (pitch and modulation wheels, aftertouch, foot controllers, etc.) can be used to control various aspects of the sound over the duration of a note. This allows the TG77 to be played with the musical expressiveness of an acoustic instrument.

Note:

The MIDI implementation chart in the back of the owners manual for your MIDI keyboard or other controller device will tell you which messages the device is able to transmit. The following explanation assumes that your keyboard has a modulation wheel which transmits MIDI control change number 1, a pitch bend wheel, and is able to transmit Channel Aftertouch.

Assign a controller to regulate vibrato

In the voice edit job directory, press F2 to get the Common data job directory and select 12:Cntrlr (controller). In this example, press F2 (Mod) to get the LFO modulation controller assignment job.

CONTROLLER SET		ELI	226
VOICE P1-A01(01) SP:Cosmo			
Modulation Depth			
	Depth	MIDI Ctrl No.	Device
Pitch	127	001	Modulation
Amplitude	0	012	Non-assigned no.
Filter	0	013	Non-assigned no.
PB	Mod	Pan	Othr

Move the cursor to the Pitch row. Set Depth to its maximum value of 127 and set 001 Modulation. With this setting, the modulation wheel will regulate the depth of pitch modulation over its full range. Move the modulation wheel and notice that vibrato deepens as you move the wheel forward. You will probably find that when the wheel is fully forward, the effect is too extreme to be musically useful. Decrease the Depth setting so that the full range of the wheel is musically useful.

In this example, you assigned the modulation wheel to control pitch modulation, but any other controller could have been used instead. It is also possible to assign two or more parameters to be regulated by the same controller.

Adjust the pitch bend range

The control assignments for pitch bend are fixed; you can bend the pitch of a TG77 voice using the pitch bend wheel and/or channel aftertouch. Press F1 (PB) to get the following display.

CONTROLLER SET	ELI	225
VOICEP1-A01(01) SPiCosmo		
Pitch Bend Range		
Pitch Bend Wheel	=	2
After Touch Pitch Bend	=	+ 8
PB Mod Pan Othr		

With the settings as shown in the display, the pitch bend wheel will bend the pitch up or down by two half steps, and aftertouch will have no effect on pitch. Modify the Pitch Bend Wheel value in the display, and move the pitch bend wheel up and down to hear how the the pitch is affected.

Next move the cursor to After Touch Pitch Bend and try out both positive and negative settings while playing a note and then varying the pressure on the keyboard.

Other controller assignments

F3 (Pan) allows you to set make controller assignments for pan, and F4 (Othr) for various other parameters.

Except for pitch bend, a different controller can be freely assigned to each parameter.

Simple editing: attack (EG)

The Envelope Generator (EG) determines how a sound attacks (begins) and decays (ends).

What is an envelope generator

Most instruments have a characteristic pattern in which the volume or tone changes over time. In electronic instruments, this is determined by the envelope generator (EG). The EG produces a fixed pattern of change over time. For example to simulate the attack and decay of a piano, you would set the volume EG to be loud when the note is first played and then gradually diminish in volume. The EGs of the TG77 allow you to specify a change over time by settings Levels and Rates. The levels are volume levels, and the rates determine the speed of change that leads to the next level.

In this example, we will be adjusting only R1 (rate 1) to change the attack of the sound.

AWM element EGs are slightly different from AFM element EGs. If you are editing an AWM element, continue to the next section "Adjusting the attack of an AWM element". If you are editing an AFM element, skip to the last section "Adjusting the attack of an AFM element".

Adjusting the attack of an AWM element

For an AWM element, the amplifier block EG determines how the volume of each note will change over time. From the AWM element 1 job directory, select 02:EG. If the Mode is set to "hold", change it to "attack".

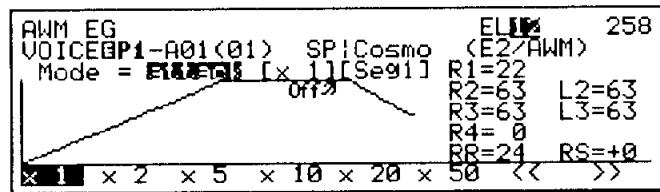

Move the cursor to R1 (rate 1) and decrease the value while repeatedly playing notes. Notice that as R1 decreases, the attack becomes slower.

Adjusting the attack of an AFM element

For an AFM element, the EG of each operator determines how each note will change over time. From the AFM element 1 job directory, select 03:EG. Press F2 (All) and then press F3 (OnR) (key-on rates).

AFM OPERATOR EG														OP	ELI
VOICEBP1-A01(01)														SP:Cosmo	(E1/AFM)
Keyon Rates & Rate Scaling															
	HT	R1	R2	R3	R4	RS		HT	R1	R2	R3	R4	RS		
1	0	30	63	63	63	+0	4	0	63	63	63	63	+0		
2	0	63	63	63	63	+0	5	0	30	63	63	63	+0		
3	0	30	63	63	63	+0	6	0	63	63	63	63	+0		
Each All OnR OnL K-of															A19

The EGs of carrier operators determine how the volume will change over time, and the EGs of modulator operators determine how the tone will change over time. To see which operators are acting as carriers, press F8 (Alg) to get a graphic display of the algorithm. The operators in the bottom row are acting as carriers.

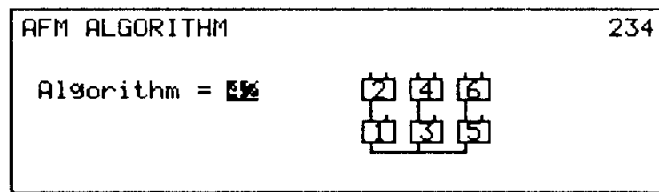

Move the cursor to R1 (rate 1) of the carrier operator(s), and decrease the value while repeatedly playing notes. Notice that as R1 decreases, the attack becomes slower.

Depending on how the modulator operators are being used, it may be necessary to decrease R1 for modulator operators as well.

How to name and store your new voice

If you have followed along with the last five “Simple editing” sections, the voice is now probably quite different than when you first selected it. Even if the voice sounds rather strange, give it a new name and store it as explained in this section.

Enter a 10-character voice name

From the voice edit Common data job directory, select 13:Name.

```
VOICE NAME                               229
VOICE#P1-A01(01)
      ↓
    [SP:Cosmo ]
-----
Clr  Uppr Lowr
```

Press F1 (Clr) to clear the currently set voice name, and use the numeric keypad to enter the characters printed below each key. Press F2 to select uppercase characters and press F3 to select lowercase characters. Use <▷> to move the cursor.

For example to enter the voice name “New1”, use <▷> to move the cursor to the beginning of the line, and press the following buttons; F2 to select uppercase, 4 three times to enter “N”, ▷, F3 to select lowercase, 1 three times to enter “e”, ▷, 7 three times to enter “w”, ▷, and 1 once to enter “1”.

Store the edited voice

When you have finished entering the voice name, press the mode select key VOICE to exit to the voice edit Common job directory, and press EXIT once again to exit voice edit mode. Since the voice data has been edited, the top line of the display will blink “AUTO-STORE VOICE”

```
AUTO-STORE VOICE
BP1-A01(01) New1
INTERNAL Bank A
01
0:SP:Cosm 05:SP:Aria 09:SP:Padf 13:AP:CP77
02:SP:Metr 06:SP:Sawp 10:SP:Twil 14:AP:Brig
03:SP:Diam 07:SP:Dark 11:SP:Anna 15:Slow Pi
04:SP:Scrp 08:SP:Myst 12:AP:Ivor 16:AP:Gran
Ret Quit Go
```

Note:

Voices which use voice mode 3 (4AFM mono), 8 (4AWM poly), and 10 (2AFM&2AWM) occupy extra memory, and can be stored only in bank D. The AUTO-STORE display for such voices will automatically show bank D, and blink “Use bank D” in the bottom line as a reminder.

Voices which use other voice modes can be stored in bank D as well.

The LCD will show the first seven characters of the voicenames in the currently selected bank of voices. The voice name displayed in inverse indicates the voice memory into which the edited data will be stored.

Press MEMORY to select internal or card memory (if a RAM card is inserted into the DATA slot). Then select a voice memory in which to store your newly edited voice by pressing BANK/SELECT to select a bank A–D and pressing –1 +1 or using the numeric keypad to directly specify a voice 1–16 in that bank.

For example to store your new voice in Internal memory bank C memory number 16, press MEMORY so that the LCD shows "INTERNAL", press BANK/SELECT so that the LCD shows "Bank C", and use the numeric keypad to enter 1, then 6.

```

AUTO-STORE VOICE
[P1-A01(01) New1
INTERNAL Bank C
01:ME:St.M 05:ME:Pick1 09:WN:Bluh 13:WN:Moot
02:ME:Blad 06:ME:Aqua 10:WN:Teno 14:WN:Saxi
03:ME:Fore 07:ME:Alps 11:WN:Clar 15:WN:Flut
04:ME:Gar9 08:ME:Cycl 12:WN:Alto 16:WN:HOSE
Ret Quit Go
    
```

The voice will be stored into this memory

Press F8 (Go), and the bottom line will ask "Are you sure ? (Yes or No)". If you are sure you want to store the edited voice, press +1/YES. You will then return to voice play mode, and the bottom line of the LCD will show "Store completed".

```

VOICE•I -C16(48) 100
New1 1AFM&1AWM
MD= 1 Mod1:Flange Rev1:Rev Hall
Mod2:Sympho Rev2:Delay L,R
Store completed !
    
```

If you decide not to store, then press F7 (Quit) to return to voice play mode.

How to edit a drum voice

A drum voice is a special type of voice which plays a different AWM sampled wave from each of the 61 notes C1-C6. This is normally used to assign drums and percussion sounds to the keyboard when creating rhythm accompaniments.

Set the voice mode to Drum Voice

In the top level of voice edit mode, press F1 (Mode) to get the voice mode job and select 11:Drum Set.

```
VOICE EDIT - Drum Set - 200
BI -C16(48) New1 11
01:1AFM mono 05:2AFM poly 09:1AFM&1AWM
02:2AFM mono 06:1AWM poly 10:2AFM&2AWM
03:4AFM mono 07:2AWM poly 11:Drum Set
04:1AFM poly 08:4AWM poly
Mode Com
```

Drum voice parameters

Press F2 (Com) to get the voice common data job directory. All drum voice parameters are contained in this job directory.

```
VOICE EDIT - Drum Set - 272
BI -C16(48) New1 01
01:Voice Volume 05:Name
02:Wave Data Set 06:-----
03:Effect Set 07:Initialize
04:Controller Set 08:Recall
Mode Com
```

As when editing a normal voice, a drum voice allows you to set the overall volume of the voice (01:Voice volume), make settings for the DSP effect units (03:Effect Set), specify the controller which will regulate the volume of the voice (04:Controller Set), and assign a name (05:Drum Set Name).

A drum voice differs from other voices mainly in the second parameter job, 02:Wave Data Set.

Wave Data Set — select a wave for each key

From the voice common data job directory, select 02:Wave Data Set.

```
WAVE DATA SET 274
VOICEBI -C16(48) New1 (Drum Set)
C 1 : Wave = Preset 96 BD 4
Level = 127 Note Shift = - 5
Alternate = off Fine Tune = + 0
Output Group = both Static Pan = + 0
Ind. Out Port = off
K-Dn K-Up Pre Card
```

This job is where you specify the AWM wave played by each key. Adjustments for level, pan, etc. can also be made independently for each key.

Press the C1 key on your MIDI keyboard, or press F1 (K-Dn) or F2 (K-Up) to select C1. Move the cursor to Waveform and select preset wave number 93 BD 1 (bass drum).

```

WAVE DATA SET
VOICE#1 -C16(48) New1 (Drum Set) 274
C 1 : Wave = Preset 93 SD 1
Level = 127 Note Shift = - 5
Alternate = off Fine Tune = + 0
Output Group = both Static Pan = + 0
Ind. Out Port = off
K-Dn K-Up Pre Card

```

Next select note C#1 and specify preset wave number 97 SD 1 (snare drum).

```

WAVE DATA SET
VOICE#1 -C16(48) New1 (Drum Set) 274
C#1 : Wave = Preset 97 SD 1
Level = 127 Note Shift = + 5
Alternate = off Fine Tune = + 0
Output Group = both Static Pan = + 0
Ind. Out Port = off
K-Dn K-Up Pre Card

```

In this way, make the following settings for notes C1-F# to create the simple seven-instrument drum set shown in the table below. For notes F and F# set Alternate to "on".

Note	Wave no.	Wave name	Alternate
C1	93	BD 1	off
C#1	97	SD 1	off
D1	102	Tom 1	off
D#1	103	Tom 2	off
E1	107	Ride	off
F1	104	HH closed	on
F#1	105	HH open	on

Alternate On/Off

Play notes C1-F#1 to play your new drum set. Notice that when you play F#1 (hi-hat open) and then quickly play F1 (hi-hat closed), the open hi-hat will stop sounding when the closed hi-hat sound begins. It is impossible for a real hi-hat to produce closed and open sounds at the same time, and this is the reason that we set these two waves to Alternate On. When two or more waves are set to alternate On, the last-played wave will take priority and the previously played wave will be turned off.

Other wave data settings

The volume of each note is adjusted by Level. The tuning of each note is adjusted in half steps by Note Shift and finely by Fine Tune. The stereo position of each note is determined by Static Pan.

The *Voice edit mode*, *Drum set data* section explains the details of these and other parameters.

Name and store your new drum voice

As explained in the previous section, give your newly created drum voice a name and store it into memory.

