

BLIMP

Suspension Windshield System

PRODUCT MANUAL



RØDE[®]
MICROPHONES



The RØDE Blimp

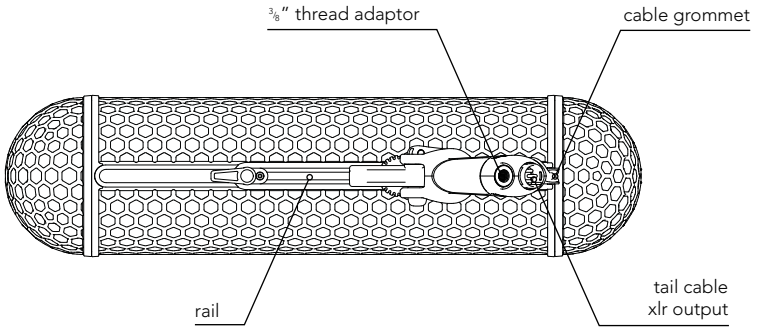
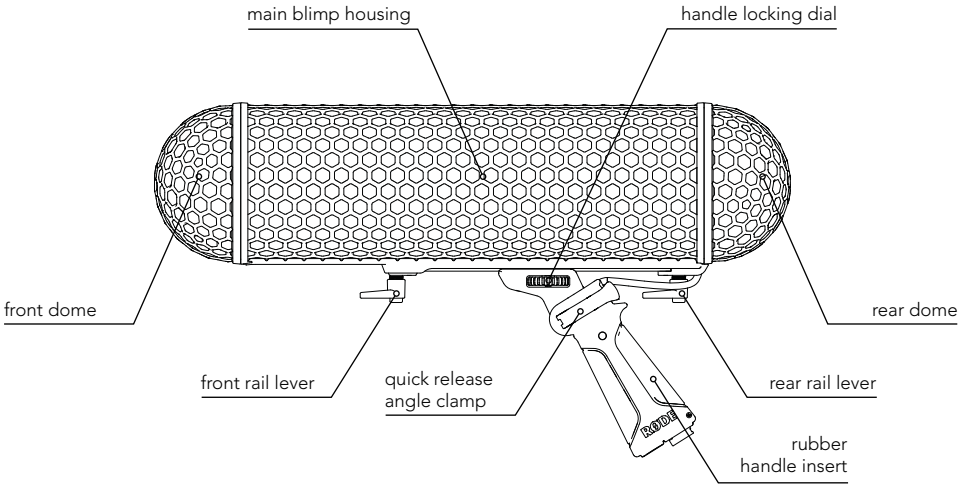

The RØDE Blimp

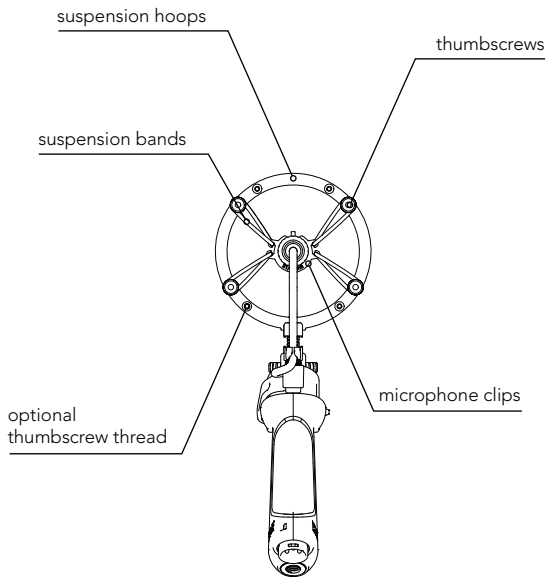
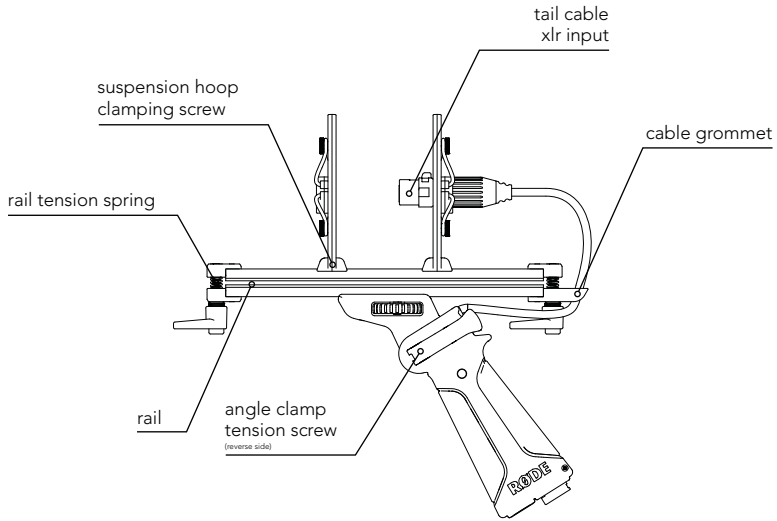

Included Accessories



The RØDE Blimp shown with standard accessories



Included Accessories

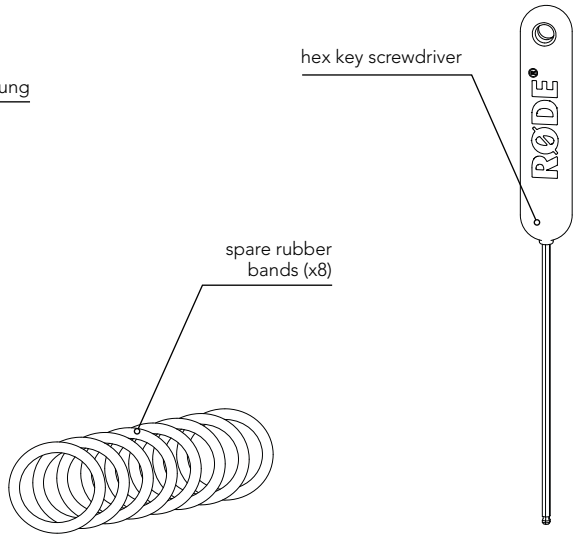
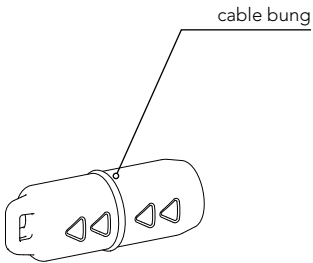
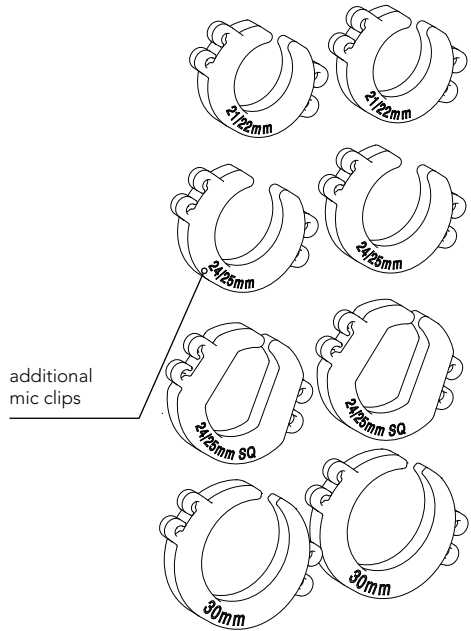
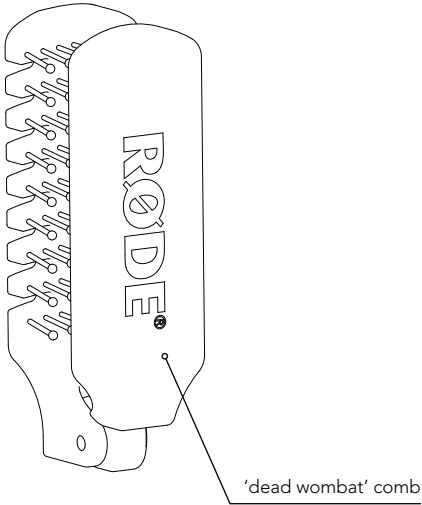

Adjusting the handle

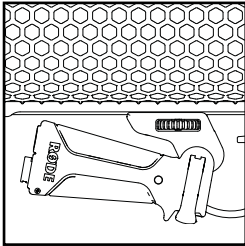

As the RØDE Blimp ships with the handle collapsed and a loose angle-clamp setting, you will need to adjust the strength of the handle angle setting.

It is recommended that you collapse the handle during transportation and storage.

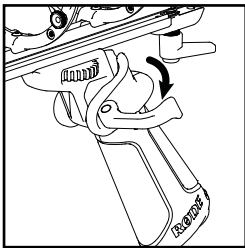

Open the 'quick release' angle clamp that can be found on the left hand side of the handle and move the handle to the desired angle.

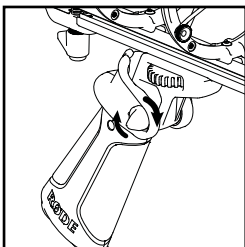

Tighten the angle clamp tension screw that can be found on the right hand side of the handle.

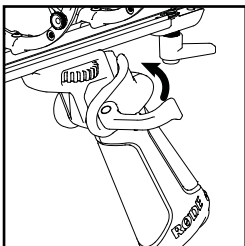

Close the angle clamp on the left hand side of the handle.

Adjusting the handle

The handle can be relocated up and down the rails to a position that offers the best weight balance & handling for the installed microphone.

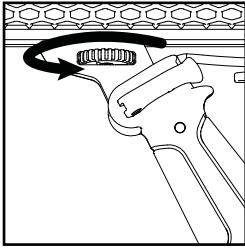

Turn the handle locking dial to the left several times to loosen the handle.

Ensure that you are supporting the blimp housing so that it does not become unstable if the locking dial is overly loosened.

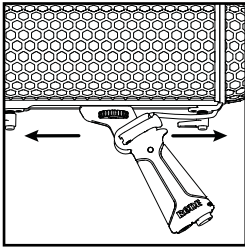

The handle can now be easily slid up or down the rail to achieve the desired balance.

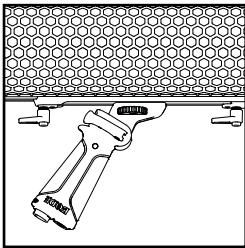

In addition to being slid up and down the rail, the handle can also be rotated 180° for greater flexibility of use.

Note that you may have to loosen the handle locking dial several turns to allow the handle to rotate.

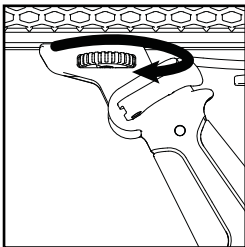

Turn the handle locking dial back to the right to tighten.

Inserting your microphone

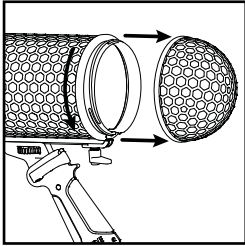

Unscrew and remove the rear dome.

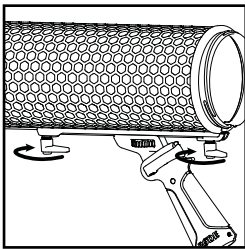

Loosen the front and rear rail levers (approximately 1-2 turns).

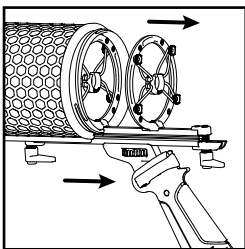

Slide the suspension body out of the Blimp housing.

To achieve optimum balance and shock mounting you may need to adjust the suspension hoop location. Instructions for this can be found later in the manual.

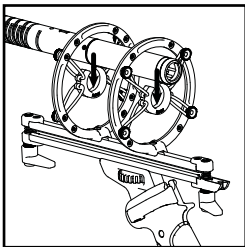

Place your microphone above the mic clips and gently push the microphone body in to the mic clips until the microphone is securely in place.

Inserting your microphone

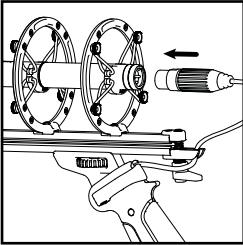

Plug the tail cable in to the microphone.

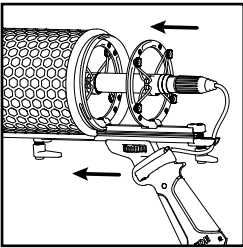

Taking care to align the rails with the main Blimp housing, slide the suspension assembly back in to the main Blimp housing.

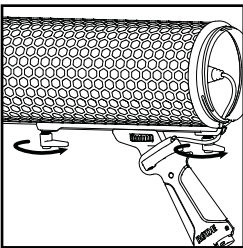

Tighten the front and rear rail levers.

Note that the levers angle itself can be adjusted independently of the screw mechanism, simply by pulling the lever itself downwards and rotating to the desired angle.

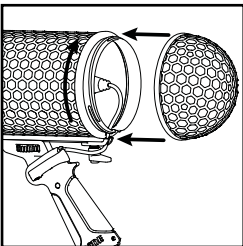

Screw the rear dome back in to place.

Adjusting the suspension mounts

The RØDE Blimp is supplied with a suspension mount setting designed to accommodate a wide range of shotgun microphones, however you may from time to time need to adjust both the microphone mounts and the suspension hoop spacing to achieve optimal balance and shock mounting.

Firstly test the additional microphone clips to find the best match to your microphone. Included sizes are:



21/22mm



24/25mm



24/25mm
Square

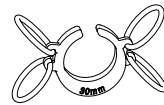

30mm

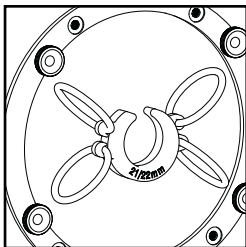

Remove existing mic clips and bands from suspension hoops, by lifting them off the thumbscrews.

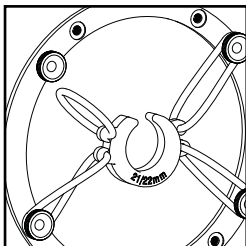

Attach the rubber bands to the desired microphone clips. All clips require four rubber bands.

Clip the rubber bands over the thumbscrews.

Adjusting the suspension mounts

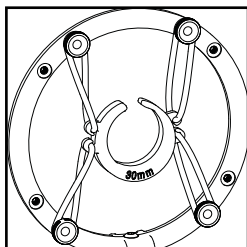

If using the 30mm clip for a significantly larger or heavier microphone (eg. NT4) the thumbscrew will need to be moved to the 'tall and narrow' configuration.

Note: When changing the position of the thumbscrews take care not to misplace the spring washer.

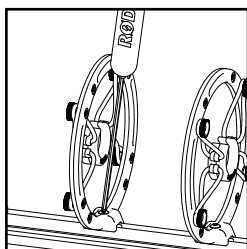

Some microphones will require the suspension hoops to be shifted forwards or backwards along the rail.

To do this, use the supplied 2mm hex screwdriver to loosen the clamp screw (no more than 2-3 turns should be necessary).

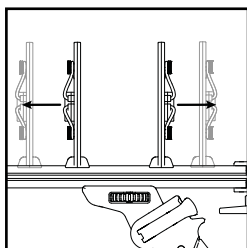

Holding the base of the suspension hoop and the rail, gently slide the hoop to the desired location.

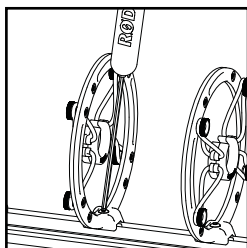

Ensuring that the hoop is centred and sitting straight up-and-down on the rail, re-tighten the clamp screw.

Removing pre-installed tail cable

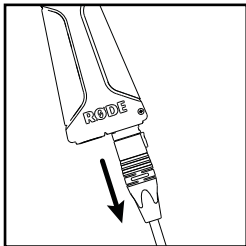

Attach an XLR cable to the tail cable output and twist while pulling to extract the tail cable socket.

Slowly extract the cable until the entire cable socket housing is exposed, then disconnect the additional cable.

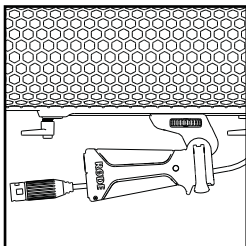

Open quick release angle clamp and collapse handle.

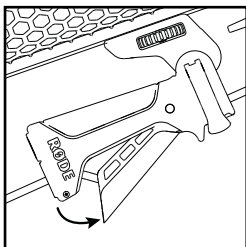

Squeezing the rubber handle insert, pull from base to remove and expose the internal cabling.

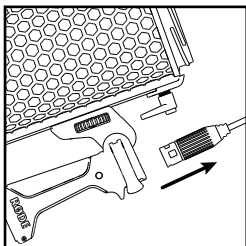

Remove the cable completely through the top of the handle.

Fitting a cable

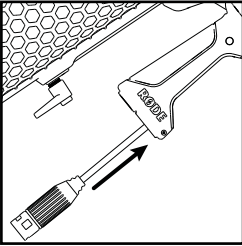

Insert microphone end of the cable in to the handle from the bottom and feed completely upwards

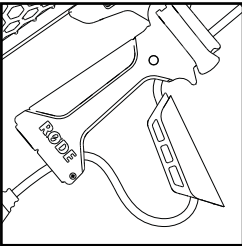

Attach the rubber handle insert to the cable.

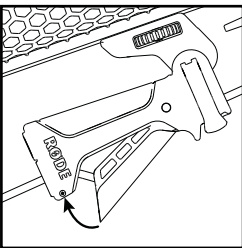

Place the rubber handle insert into the handle.

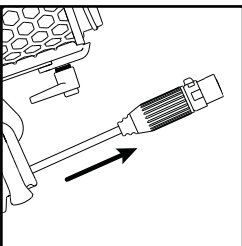

Pull the cable from the top to achieve the desired length to comfortably connect to the microphone.

Fitting a cable

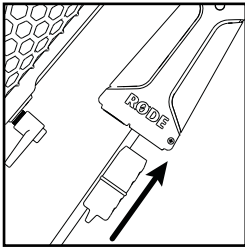

Align the bung with the cable underneath the handle and push it in to the cavity of the handle to secure the cable tightly in place.

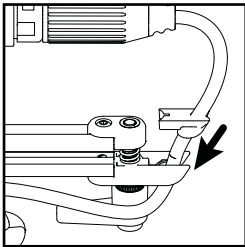

Place the cable in the grommet and place the grommet in its seating.

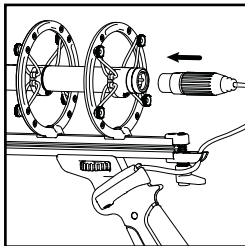

Connect the cable to the microphone and adjust the handle to the desired angle for use.

Using the 'Dead Wombat'



Insert the Blimp head-first, taking care to align the seam on the dead wombat with the rail on the underside of the Blimp.



Loosen the drawstring on the dead wombat and carefully stretch the dead wombat over the rear dome.



Straighten the dead wombat, then tighten and lock the drawstring.

It is recommended to hook the drawstring over the front rail lever to prevent any handling noise.



Brush the dead wombat from front to back to lift the hair and prevent matting.

This greatly assists in wind noise protection as well as extends the life of the dead wombat.

The cable grommet

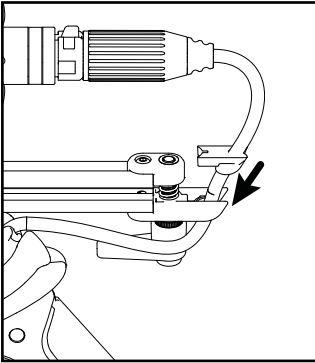

The cable grommet serves two purposes – to prevent wind noise from entering the Blimp, and to isolate and reduce any handling noise that may otherwise be transferred from the cable to the microphone.

If using a thicker cable (7mm+ diameter) the grommet may not be required.

Laundering Instructions for Dead Wombat

We recommend that the Blimp DeadWombat be dry cleaned, however it can be hand washed in mild soapy water, rinsed well and air dried.

Once dry, thoroughly comb the synthetic fur to remove any knots and maximise product life.

RØDE[®]
MICROPHONES



Australia

107 Carnarvon st, Silverwater NSW 2128 Australia
Ph: +61 2 9648 5855 Fx: +61 2 9648 2455

USA

PO Box 4189, Santa Barbara CA 93140 USA
Ph: +1 805 566 7777 Fx: +1 805 566 0071