

YAMAHA[®]

**AUTHORIZED
PRODUCT MANUAL**

SPX1000

Professional Multi-effect Processor

YAMAHA

SPX1000

Professional Multi-effect Processor

Operation Manual

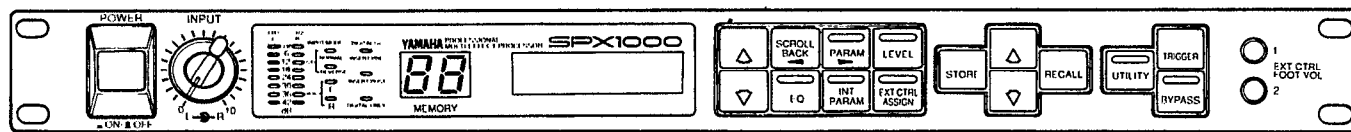

INTRODUCTION

Congratulations on your acquisition of a Yamaha SPX1000 Professional Multi-effect Processor. The SPX1000 is a highly sophisticated digital reverberation and effects system which offers 40 preset effect programs including accurate simulations of natural reverberation and early-reflections, delay and echo effects, gated effects, modulation effects, a versatile compressor, a low-level expander, a harmonic exciter, multiple effects which function as several SPX000 units in one, independent 2-channel effects, freeze (sampling) programs and others. With a sampling frequency of 44.1 kHz, it delivers full, flat frequency response from 20 Hz to 20 kHz for exceptionally clean, "transparent" effect sound, and direct digital interfacing capability makes it compatible with the most up-to-date sound systems. The preset effect programs can be edited, re-titled, and stored in any of 59 RAM user memory locations. Individual two-band parametric EQ and dynamic filter parameters are provided for each effect program for precise tonal tailoring. In addition to the basic effect and EQ parameters, the SPX1000 offers a list of "internal parameters" which provide exacting control over the effect sound. The SPX1000 is also MIDI compatible, with a MIDI IN terminal that allows MIDI selection of effect programs, and a switchable MIDI THRU/OUT terminal. When switched to OUT, edited programs stored in internal RAM can be dumped to a MIDI data recorder or other data storage device. Programs thus stored can be reloaded when necessary via the MIDI IN terminal. As an extra touch of convenience the SPX1000's analog input and output terminals can be switched to match -20 dBm or +4 dBm line levels + providing compatibility with a broader range of sound equipment.

In order to fully take advantage of all the capability offered by the SPX1000 Professional Multi-effect Processor, we urge you to read this operation manual thoroughly—and keep it in a safe place for later reference.

FCC INFORMATION

While the following statements are provided to comply with FCC Regulations in the United States, the corrective measures listed below are applicable worldwide.

This series of Yamaha professional music equipment uses frequencies that appear in the radio frequency range and if installed in the immediate proximity of some types of audio or video devices (within three meters), interference may occur. This series of Yamaha combo equipment have been type tested and found to comply with the specifications set for a class B computing device in accordance with those specifications listed in subpart J of part 15 of the FCC rules. These rules are designed to provide a reasonable measure of protection against such interference. However, this does not guarantee that interference will not occur. If your professional music equipment should be suspected of causing interference with other electronic devices, verification can be made by turning your combo equipment off and on. If the interference continues when your equipment is off, the equipment is not the source of interference. If your equipment does appear to be the source of the interference, you should try to correct the situation by using one or more of the following measures:

Relocate either the equipment or the electronic device that is being affected by the interference. Utilize power outlets for the professional music equipment and the device being affected that are on different branch (circuit breaker or fuse) circuits, or install AC line filters.

In the case of radio or TV interference, relocate the antenna or, if the antenna lead-in is 300 ohm ribbon lead, change the lead-in to co-axial type cable.

If these corrective measures do not produce satisfactory results, please contact your authorized Yamaha professional products dealer for suggestions and/or corrective measures.

If you cannot locate a franchised Yamaha professional products dealer in your general area contact the professional products Service Department, Yamaha Music Corporation, 6600 Orangethorpe Ave., Buena Park, CA 90620, U.S.A.

If for any reason you should need additional information relating to radio or TV interference, you may find a booklet prepared by the Federal Communications Commission helpful:

"How to identify and Resolve Radio-TV Interference Problems". This booklet is available from the U.S. Government Printing Office, Washington D.C. 20402 - Stock No. 004-000-00345-4.

TABLE OF CONTENTS

PRECAUTIONS

1: CONTROLS AND CONNECTIONS	3
THE FRONT PANEL	3
THE CONNECTOR PANEL	5
2: THE SPX1000 SYSTEM	6
MEMORY CONFIGURATION	6
INPUT MODE AND DIGITAL I/O CONFIGURATIONS	6
INPUT MODES	6
DIGITAL I/O MODES.....	7
3: GENERAL OPERATION	9
SELECTING AN EFFECT/MEMORY LOCATION	9
BYPASSING THE EFFECT	9
ACCESSING & EDITING THE PROGRAM PARAMETERS	9
STORING EFFECTS.....	10
EXTERNAL CONTROL ASSIGNMENT	10
4: THE PROGRAMS & PARAMETERS	12
PARAMETERS PROVIDED FOR ALL PROGRAMS..	12
LEVEL PARAMETERS (Accessed via LEVEL key)	12
EQ PARAMETERS (Accessed via EQ key)	12
REVERB PROGRAMS	13
■ 1. REV 1 HALL	13
■ 2. REV 2 ROOM	13
■ 3. REV 3 VOCAL	13
■ 4. REV 4 PLATE	14
■ 5. REV 5 ECHO ROOM	15
EARLY REFLECTION PROGRAMS.....	15
■ 6. EARLY REF. 1	15
■ 7. EARLY REF. 2	15
■ 8. EARLY REF. 3	15
■ 9. GATE REVERB	15
■ 10. REVERSE GATE.....	15
DELAY PROGRAM	17
■ 11. DELAY L,C,R.....	17
ECHO PROGRAM.....	17
12. STEREO ECHO.....	17
MODULATION PROGRAMS	18
■ 13. STEREO FLANGE A	18
■ 14. STEREO FLANGE B.....	18
■ 15. CHORUS	18
■ 16. STEREO PHASING.....	18
■ 17. TREMOLO.....	18
■ 18. SYMPHONIC.....	18
NOISE GATE	19
■ 19. ADR-NOISE GATE.....	19

PITCH CHANGE PROGRAMS.....	19
■ 20. PITCH CHANGE 1.....	20
■ 21. PITCH CHANGE 2.....	20
■ 22. PITCH CHANGE 3.....	20
■ 39. STEREO PITCH.....	21
FREEZE PROGRAMS	21
■ 23. FREEZE 1	21
■ 24. FREEZE 2	23
■ 40. STEREO FREEZE	23
PAN PROGRAMS.....	23
■ 25. PAN	24
■ 26. TRIGGERED PAN	24
DISTORTION PROGRAM.....	24
■ 27. DISTORTION	24
MULTI-EFFECT PROGRAMS.....	25
■ 28. MULTI (CHO&REV)	25
■ 29. MULTI (SYM+REV).....	26
■ 30. MULTI (EXC&REV)	26
2-CHANNEL PROGRAMS	26
■ 31. PLATE + HALL	26
■ 32. ER + REV	27
■ 33. ECHO + REV	27
■ 34. CHORUS + REV	28
■ 35. PAN + PAN	28
COMPRESSOR & EXPANDER PROGRAMS.....	29
■ 36. COMPRESSOR	29
■ 37. LO LVL EXPANDER	30
EXCITER PROGRAM.....	30
■ 38. EXCITER.....	30
5: UTILITY FUNCTIONS	31
TITLE EDIT.....	31
INPUT MODE	31
A/D I/O MODE	31
DIGITAL IN ATT	31
USER ER EDIT	31
MEMORY PROTECT	32
MIDI CONTROL & MIDI PGM CHANGE	32
MIDI CTRL ASSIGN	33
BULK OUT 1 & BULK OUT 2.....	33
F.SW MEMORY RCL	34
6: DATA & SPECIFICATIONS	Add-1
ROM CONTENTS AND CONTROLLABLE PARAMETERS	Add-1
MIDI DATA FORMAT	Add-15
MIDI IMPLEMENTATION CHART	Add-28
BLOCK DIAGRAM.....	Add-29
DIMENSIONS	Add-30
SPECIFICATIONS	Add-31

PRECAUTIONS

1. AVOID EXCESSIVE HEAT, HUMIDITY, DUST AND VIBRATION

Keep the unit away from locations where it is likely to be exposed to high temperatures or humidity – such as near radiators, stoves, etc. Also avoid locations which are subject to excessive dust accumulation or vibration which could cause mechanical damage.

2. AVOID PHYSICAL SHOCKS

Strong physical shocks to the unit can cause damage. Handle it with care.

3. DO NOT OPEN THE CASE OR ATTEMPT REPAIRS OR MODIFICATIONS YOURSELF

This product contains no user-serviceable parts. Refer all maintenance to qualified Yamaha service personnel. Opening the case and/or tampering with the internal circuitry will void the warranty.

4. MAKE SURE POWER IS OFF BEFORE MAKING OR REMOVING CONNECTIONS

Always turn the power OFF prior to connecting or disconnecting cables. This is important to prevent damage to the unit itself as well as other connected equipment.

5. HANDLE CABLES CAREFULLY

Always plug and unplug cables – including the AC cord – by gripping the connector, not the cord.

6. CLEAN WITH A SOFT DRY CLOTH

Never use solvents such as benzine or thinner to clean the unit. Wipe clean with a soft, dry cloth.

7. ALWAYS USE THE CORRECT POWER SUPPLY

Make sure that the power supply voltage specified on the rear panel matches your local AC mains supply.

8. ELECTRICAL INTERFERENCE

Since the SPX000 contains digital circuitry, it may cause interference and noise if placed too close to TV sets, radios or similar equipment. If such a problem does occur, move the SPX1000 further away from the affected equipment.

9. BACKUP BATTERY

The SPX1000 contains a long-life lithium battery which maintains the contents of the buffer and user memory locations even when the unit is turned OFF. With normal use the battery should last for approximately 5 years. If the battery voltage falls below the safe level, however, the "*** WARNING *** LOW BATTERY" display will appear on the LCD when the power is first turned ON. If this occurs, have the battery replaced by a qualified Yamaha service center. Do not attempt to replace the battery yourself!

IMPORTANT NOTICE FOR THE UNITED KINGDOM

Connecting the Plug and Cord

WARNING : THIS APPARATUS MUST BE EARTHED

IMPORTANT. The wires in this mains lead are coloured in accordance with the following code:

GREEN-AND-YELLOW : EARTH
BLUE : NEUTRAL
BROWN : LIVE

As the colours of the wires in the mains lead of this apparatus may not correspond with the coloured markings identifying the terminals in your plug proceed as follows:

The wire which is coloured GREEN-AND-YELLOW must be connected to the terminal in the plug which is marked by the letter E or by the safety earth symbol  or coloured GREEN or GREEN-AND-YELLOW.

The wire which is coloured BLUE must be connected to the terminal which is marked with the letter N or coloured BLACK.

The wire which is coloured BROWN must be connected to the terminal which is marked with the letter L or coloured RED.

CANADA

THIS APPARATUS COMPLIES WITH THE "CLASS B" LIMITS FOR RADIO NOISE EMISSIONS SET OUT IN RADIO INTERFERENCE REGULATIONS.

CET APPAREIL EST CONFORME AUX NORMES "CLASSE B". POUR BRUITS RADIO-ELECTRIQUES. TEL QUE SPECIFIER DANS LE REGLEMENT SUR LE BROUILLAGE RADIOELECTRIQUE.

1: CONTROLS AND CONNECTIONS

THE FRONT PANEL

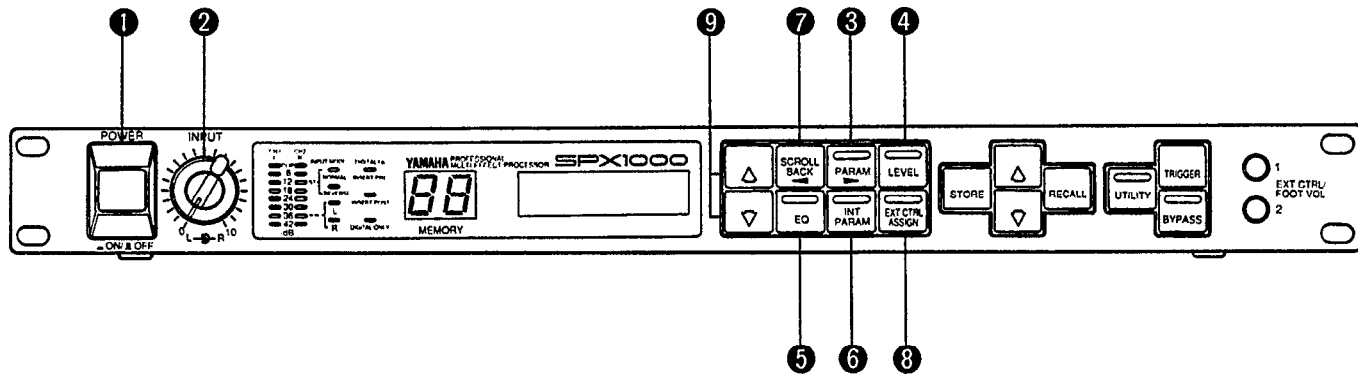

1 Power ON/OFF Switch

Press to turn power ON, press again to turn power OFF. When the power is turned ON, the last program and parameter selected will be automatically recalled.

2 Input Level Controls

These concentric controls vary the input level of the analog inputs from approximately -90 dB to +10 dB when the rear-panel input level switch is set to +4 dB, and between approximately -110 dB and -14 dB when the input level switch is set to -20 dB. The inner control adjusts the left channel and the outer control adjusts the right channel.

3 PARAM Key ▶

Accesses the main effect parameters for each program. Each time the PARAM key is pressed the next parameter in the selected program's "parameter set" is called. It is also possible to scroll backward through the parameter set by using the SCROLL BACK key (7). Once the desired parameter has been selected its value or setting can be changed using the parameter Δ and ∇ keys (9). The PARAM key is also used for cursor control (forward cursor movement) in some utility functions.

- Details under "THE PROGRAMS & PARAMETERS" starting on page 12

4 LEVEL Key

Accesses the output level and balance parameters for each program. Once the LEVEL key has been pressed, both the LEVEL key and SCROLL BACK (7) key can be used to select parameters. Once the desired parameter has been selected its value or setting can be changed using the parameter Δ and ∇ keys (9).

- Details on page 12

5 EQ Key

Accesses the digital equalizer or dynamic filter parameters for each program. Once the EQ key has been pressed, both the EQ key and SCROLL BACK (7) key can be used to select parameters. Once the desired parameter has been selected its value or setting can be changed using the parameter Δ and ∇ keys (9).

- Details on page 12

6 INT PARAMETER Key

Accesses a special set of internal parameters for each effect program. Once the INT PARAM key has been pressed, both the INT PARAM key and SCROLL BACK (7) key can be used to select parameters. Once the desired parameter has been selected its value or setting can be changed using the parameter Δ and ∇ keys (9).

- Details under "THE PROGRAMS & PARAMETERS" starting on page 12

7 SCROLL BACK Key ◀

When any set of parameters is selected – PARAM, LEVEL, EQ, or INT PARAM – the SCROLL BACK key can be used to scroll backward through the available parameters while the PARAM (3), LEVEL (4), EQ (5) or INT PARAMETER (6) key scrolls forward, according to the parameter set selected. The preceding parameter in the current set is selected each time the SCROLL BACK key is pressed. The SCROLL BACK key is also used for cursor control (backward cursor movement) in some utility functions.

8 EXT CTRL ASSIGN Key

This key makes it possible to assign any parameters (PARAM, LEVEL, EQ or INT PARAM) to external controllers connected to the front-panel EXT CTRL/ FOOT VOL 1 and 2 jacks (21). These controllers can then be used to control the assigned parameter in real time. Yamaha FC7 Foot Controllers are recommended.

- Details on page 10

9 Parameter Δ and ∇ Keys

These keys are used to change parameter values when parameters are selected for editing (after the PARAM, LEVEL, EQ or INT PARAM key has been pressed). The parameter Δ and ∇ keys are also used to program several UTILITY functions. The Δ and ∇ keys can be pressed briefly to change values in single steps, or held down for rapid continuous incrementing or decrementing of the selected value. While holding down either the Δ or ∇ key, pressing the other key (Δ or ∇) causes the incrementing or decrementing process to be carried out more rapidly.

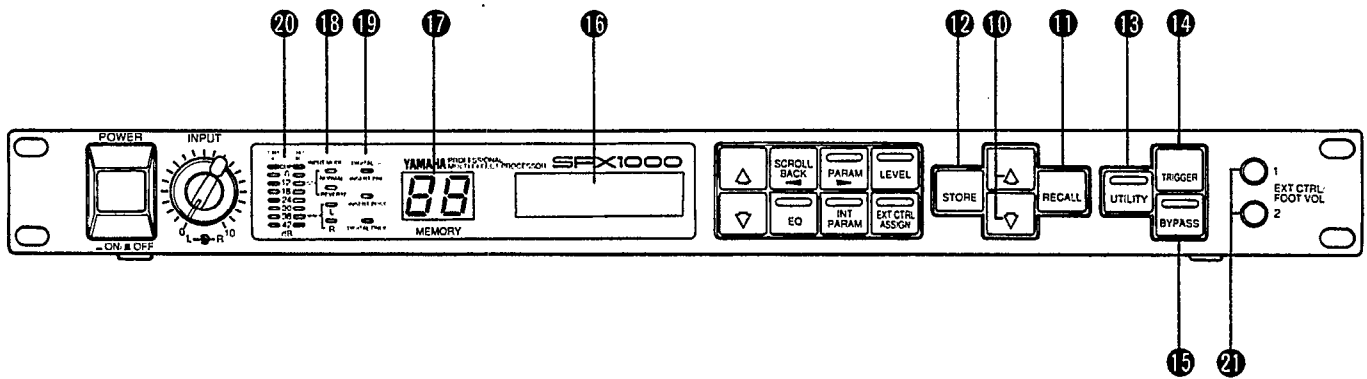

10 Program Select Δ and ∇ Keys

These keys are used to select any of the SPX1000's memory locations. The Δ key increments (increases) the memory location number while the ∇ key decrements (decreases) the memory location number. Holding either key down causes continuous scrolling in the specified direction.

- Details on page 9

11 RECALL Key

When a new memory location number has been selected using the program select Δ and ∇ keys, the RECALL key must be pressed to activate the selected effect.

- Details on page 9

12 STORE Key

This key is used to store edited effect programs into one of the user memory locations between 41 and 99.

- Details on page 10

13 UTILITY Key

This key accesses a set of utility functions allowing selection of the SPX1000's input/output mode, editing of effect titles, creation of original early-reflection patterns, MIDI control programming, footswitch recall range programming and others.

- Details on page 31

14 TRIGGER Key

The TRIGGER key allows manual triggering of any SPX1000 effect program that has trigger parameters. The reverb programs, for example, include a triggerable gate, and the freeze programs allow triggering of recording and playback. The TRIGGER key has the same function as a footswitch plugged into the rear-panel TRIGGER 1 SW jack (THE CONNECTOR PANEL, 6).

15 BYPASS Key

The BYPASS key switches the selected effect ON or OFF, leaving only the direct signal when BYPASS is active. The BYPASS key has the same function as a footswitch plugged into the rear-panel BYPASS jack (THE CONNECTOR PANEL, 4).

- Details on page 9

16 LCD (Liquid Crystal Display)

This 16-character x 2-line liquid crystal display panel normally displays the title of the selected effect on the top line and a selected parameter and its value on the bottom line. One or both lines may also be used to display error messages or warnings. "M" will be displayed in the upper right corner after receiving the MIDI data.

17 LED Memory Number Display

This 2-digit numeric display shows the number of the currently selected memory location (1 – 99). When the LED display is continuously lit the effect corresponding to the number displayed is active. When the LED display is flashing, this indicates that a new memory location has been selected but has not yet been recalled, leaving the previously selected effect active.

18 INPUT MODE Indicators

Indicate the selected input mode.

- Details on page 6

19 DIGITAL I/O Indicators

Indicate the selected DIGITAL I/O mode.

- Details on page 7

20 Input Level Meter

The stereo input level meter consists of eight LED segments per channel, corresponding to -42 dB, -36 dB, -30 dB, -24 dB, -18 dB, -12 dB, -6 dB and CLIP input level.

21 EXT CTRL/FOOT VOL 1 and 2 Jacks

Optional Yamaha FC7 Foot Controllers plugged into these jacks can be used to directly control SPX1000 effect program parameters. The parameters to be controlled are assigned to the controllers using the EXT CTRL ASSIGN key (8).

- Details on page 10

THE CONNECTOR PANEL

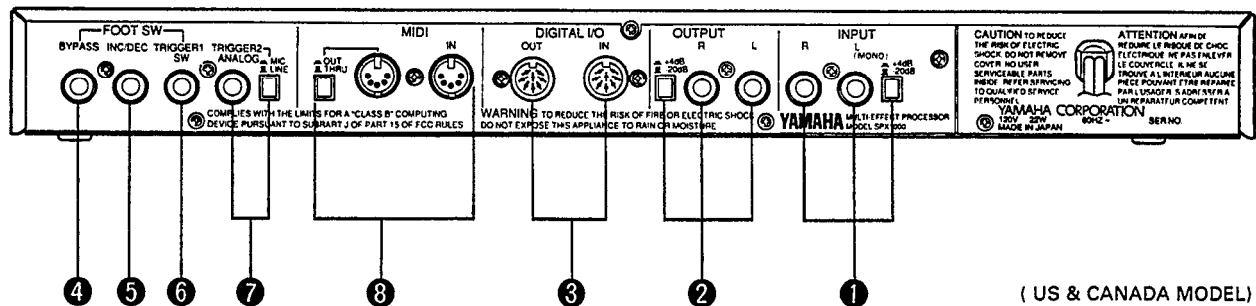

1 L(MONO) & R INPUT Connectors and Level Switch

These are the analog stereo inputs to the SPX1000. The input jacks are standard 1/4" monaural phono types. The level switch selects either -20 dB or +4 dB nominal input level. Please note that the operation of the INPUT jacks depends on the selected INPUT and DIGITAL I/O modes. Refer to "INPUT MODES" and DIGITAL I/O MODES" on page 6 for details.

When an input mode has not been selected and only one input is being used, input is through L(MONO).

2 L & R OUTPUT Connectors and Level Switch

The stereo analog outputs from the SPX1000. The output jacks are standard 1/4" monaural phono types. The level switch selects either -20 dB or +4 dB nominal output level. Please note that the operation of the OUTPUT jacks depends on the selected DIGITAL I/O mode. Refer to "DIGITAL I/O MODES" on page 7 for details.

3 DIGITAL IN and OUT Connectors

These are the SPX1000's stereo digital inputs and outputs. All digital data is handled in Yamaha format. The DIGITAL IN and OUT connectors are directly compatible with other Yamaha equipment that provides digital I/O capability – the DMP7D Digital Mixing Processor and DEQ7 Digital Equalizer are excellent examples. The Yamaha FMC1 Format Converter can also be used to convert the SPX1000's digital output to virtually all popular digital formats, allowing direct connection to standard digital recorders, etc. Please note that the operation of the DIGITAL IN and OUT jacks depends on the selected DIGITAL I/O mode. Refer to "DIGITAL I/O MODES" on page 7 for details.

4 BYPASS Footswitch Jack

An optional Yamaha FC5 footswitch or equivalent connected to this jack can be used for foot control of the BYPASS function.

- Details on page 9

5 INC/DEC Footswitch Jack

An optional Yamaha FC5 footswitch or equivalent connected to this jack can be used to recall a range of programs specified by the UTILITY mode F.SW MEMORY RECALL RANGE function.

- Details on page 34

6 TRIGGER 1 SW Footswitch Jack

The TRIGGER 1 SW footswitch jack accepts a Yamaha FC5 or equivalent footswitch for foot-controlled triggering of any SPX1000 effect program that has trigger parameters. The reverb programs, for example, include a triggerable gate, and the freeze programs allow triggering of recording and playback. A footswitch connected to the TRIGGER 1 SW jack has the same function as the front-panel TRIGGER key (THE FRONT PANEL, 14).

7 TRIGGER 2 ANALOG Jack & MIC/LINE Switch

The triggerable SPX1000 effect programs (gate programs, freeze programs, etc.) can be triggered by the front-panel TRIGGER key, a footswitch connected to the TRIGGER 1 SW jack, or an input signal appearing at the INPUT L and R or DIGITAL IN connectors. The TRIGGER 2 ANALOG jack offers a fourth triggering method: triggering can be accomplished by applying an analog signal of sufficient amplitude to this jack. The MIC/LINE switch changes the sensitivity of the TRIGGER 2 ANALOG input to accept microphone or line-level signals.

8 MIDI IN and THRU/OUT Terminals

MIDI signals from external MIDI devices can be fed to the MIDI IN terminal to remotely select effects, set the pitch shift of the pitch change effects and set the pitch of freeze-program playback. When the switch controlling the remaining MIDI terminal is set to THRU, the terminal simply re-transmits data received at the MIDI IN terminal allowing daisy-chaining of MIDI devices. When set to OUT, the internal RAM memory contents may be dumped to a MIDI data recorder for large-volume, long-term storage. Program data thus stored can be reloaded later via the MIDI IN terminal (see BULK OUT 1 & BULK OUT 2 on page 33).

(US & CANADA MODEL)

2: THE SPX1000 SYSTEM

MEMORY CONFIGURATION

The SPX1000 has a total of 99 internal memory locations. Locations 1 through 40 are READ-ONLY MEMORY containing 40 preset effect programs. These locations cannot be written to or changed in any way. The preset effect programs contained in memory locations 1 through 40 are:

- | | |
|---------------------|---------------------|
| 1. REV 1 HALL | 21. PITCH CHANGE 2 |
| 2. REV 2 ROOM | 22. PITCH CHANGE 3 |
| 3. REV 3 VOCAL | 23. FREEZE 1 |
| 4. REV 4 PLATE | 24. FREEZE 2 |
| 5. REVS ECHO ROOM | 25. PAN |
| 6. EARLY REF. 1 | 26. TRIGGERED PAN |
| 7. EARLY REF. 2 | 27. DISTORTION |
| 8. EARLY REF. 3 | 28. MULTI (CHO&REV) |
| 9. GATE REVERB | 29. MULTI (SYM+REV) |
| 10. REVERSE GATE | 30. MULTI (EXC&REV) |
| 11. DELAY L,C,R | 31. PLATE + HALL |
| 12. STEREO ECHO | 32. ER + REV |
| 13. STEREO FLANGE A | 33. ECHO + REV |
| 14. STEREO FLANGE B | 34. CHORUS + REV |
| 15. CHORUS | 35. PAN + PAN |
| 16. STEREO PHASING | 36. COMPRESSOR |
| 17. TREMOLO | 37. LO LVL EXPANDER |
| 18. SYMPHONIC | 38. EXCITER |
| 19. ADR-NOISE GATE | 39. STEREO PITCH |
| 20. PITCH CHANGE 1 | 40. STEREO FREEZE |

Locations 41 through 99 are READ/WRITE MEMORY which can be used to store your own edited versions of the preset programs.

INPUT MODE AND DIGITAL I/O CONFIGURATIONS

The SPX1000 offers a choice of input modes as well as analog and digital input/output configurations, providing extraordinary flexibility in “adapting” to various systems and requirements.

INPUT MODES

The SPX1000 offers the following input modes, regardless of the selected DIGITAL I/O mode:

STEREO NORMAL

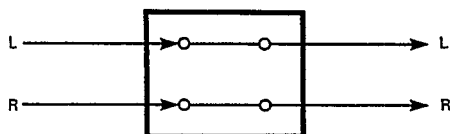

This is the normal mode of operation in which left- and right-channel signals received at the left- and right-channel inputs are passed on to the SPX1000 processing circuitry on the same channels as which they were received.

STEREO REVERSE

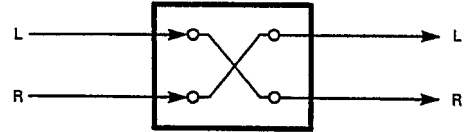

In this input mode the received left- and right-channel signals are switched to the opposite channels. The left-channel input is fed to the right-channel processing circuitry and the right-channel input signal is fed to the left-channel processing circuitry.

MONO LEFT

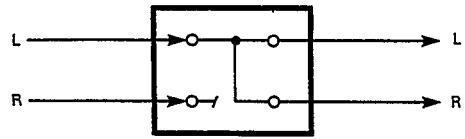

This and the MONO R mode described below are ideal for use with monaural input signals. In the MONO L mode a monaural signal received at the INPUT L jack is fed to both the left- and right-channel processing circuitry.

MONO RIGHT

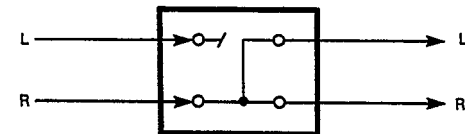

A monaural signal received at the INPUT R jack is fed to both the left- and right-channel processing circuitry.

Selecting an Input Mode

Input modes are selected using the utility-mode INPUT MODE function.

1. Press the UTILITY key twice to call the INPUT MODE function.

INPUT MODE
STEREO NORMAL

- Use the parameter select Δ and ∇ keys to select the desired input mode. The name of the selected input mode should now be flashing on the LCD.
- Press the STORE key to activate the selected input mode. The name of the selected mode will stop flashing and the corresponding INPUT MODE indicator LED will light (ST NORMAL, ST REVERSE, MONO L or MONO R).
- Press and hold the UTILITY key until its indicator goes out and the utility mode is exited.

DIGITAL I/O MODES

The SPX1000 has the following DIGITAL I/O modes which determine the operation of its analog and digital inputs and outputs.

ANALOG

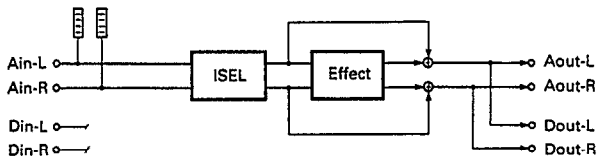

In this mode the DIGITAL IN connector is inactive and the SPX1000 receives input via the analog INPUT L and R jacks. Both the analog OUTPUT L and R and DIGITAL OUT connectors are active so that the SPX1000's output can be simultaneously fed to analog and digital equipment if required.

PRE(INSERT PRE)

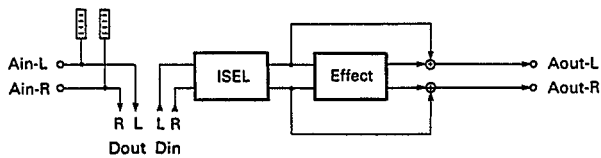

In this mode the SPX1000 receives input via the analog INPUT L and R jacks. The DIGITAL IN and OUT jacks function as a pre-effect insert point, allowing a second SPX1000 or other Yamaha-format digital device to be inserted into the signal path prior to both the input selector and effect processor. Output is delivered via the analog OUTPUT L and R jacks.

POST(INSERT POST)

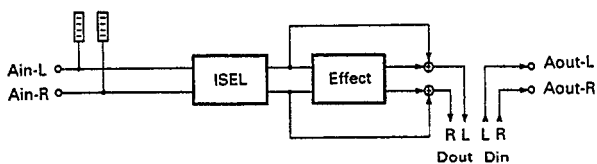

In this mode the SPX1000 receives input via the analog INPUT L and R jacks. The DIGITAL IN and OUT jacks function as a post-effect insert point, allowing a second SPX1000 or other Yamaha-format digital device to be inserted into the signal path after the effect processor. Output is delivered via the analog OUTPUT L and R jacks.

DIGITAL(DIGITAL ONLY)

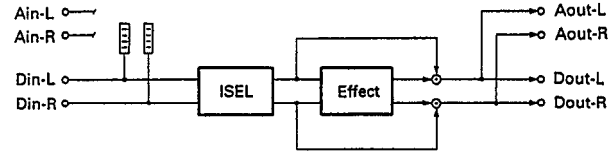

In this mode the analog INPUT L and R jacks are inactive and the SPX1000 receives input via the DIGITAL IN connector. Both the analog OUTPUT L and R and DIGITAL OUT connectors are active so that the SPX1000's output can be simultaneously fed to analog and digital equipment if required.

Selecting a DIGITAL I/O Mode

DIGITAL I/O modes are selected using the utility-mode A/D I/O MODE function.

- Press the UTILITY key three times to call the A/D I/O MODE function. This function has two parameters: MODE and CLK (clock). The MODE parameter can be set to any of the four DIGITAL I/O modes described above: ANA (Analog), PRE, PST (Post), or DIG (Digital). When the DIG, PRE or PST mode is selected, the CLK parameter can be set to INT (Internal) or EXT (External), determining whether the digital clock signal is derived from the SPX1000's own internal clock generator (INT) or the clock signal included in the digital input signal received via the DIGITAL IN connector (EXT). When the ANA mode is selected the CLK parameter is fixed at INT.
- Use the parameter select Δ and ∇ keys to select the desired DIGITAL I/O MODE. The name of the selected mode should now be flashing on the LCD.
- If necessary, press the PARAM Δ key to move the underline cursor to the CLK parameter and use the parameter select Δ and ∇ keys to select the desired CLK setting. The SCROLL BACK ∇ key can be used to move the underline cursor back to the MODE parameter if necessary.
- Press the STORE key to activate the selected DIGITAL I/O mode and CLK setting. The name of the selected mode will stop flashing and the corresponding DIGITAL I/O indicator LED will light (INSERT PRE, INSERT POST or DIGITAL ONLY). None of the DIGITAL I/O indicators will light if the ANA mode is selected.

- Press and hold the UTILITY key until its indicator goes out and the utility mode is exited.

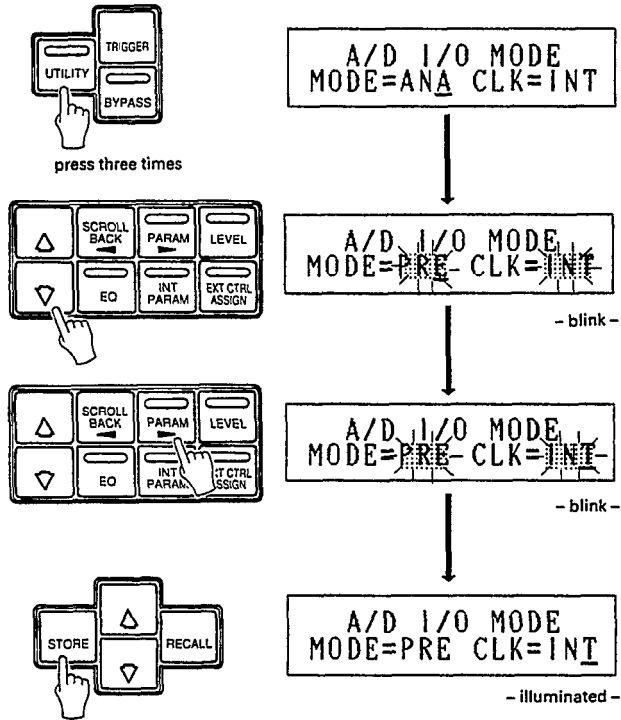

CAUTION!

When the SPX1000 clock (CLK) mode is switched from internal (INT) to external (EXT), or vice-versa, a noise pulse may appear at the outputs. This also occurs if the SPX1000 is switched from digital to analog input while CLK is set to EXT (CLK is automatically reset to INT in this case).
 Be sure to lower the volume level of equipment connected to the SPX1000 outputs when performing any of above operations.

3: GENERAL OPERATION

SELECTING AN EFFECT/MEMORY LOCATION

- Effects and memory locations can only be selected when the utility mode is not active (the UTILITY KEY indicator is not lit). If the UTILITY key indicator is lit, press and hold the UTILITY key until its indicator goes out and the utility mode is exited.
- Press the program select Δ or ∇ key to increment or decrement the memory location number shown on the LED display. Hold either of these keys down for continuous incrementing or decrementing. The name of the program corresponding to the currently selected memory location will be shown on the LCD, or "*** NO DATA ***" will be displayed if a memory location between 41 and 99 is selected into which an edited effect program has not been stored. Note that at this stage the LED memory number display is flashing, indicating that although a new location has been selected, its contents have not yet been recalled.
- When the desired memory location/effect has been selected, press the RECALL key. The LED memory number display will stop flashing and the selected effect will be engaged.

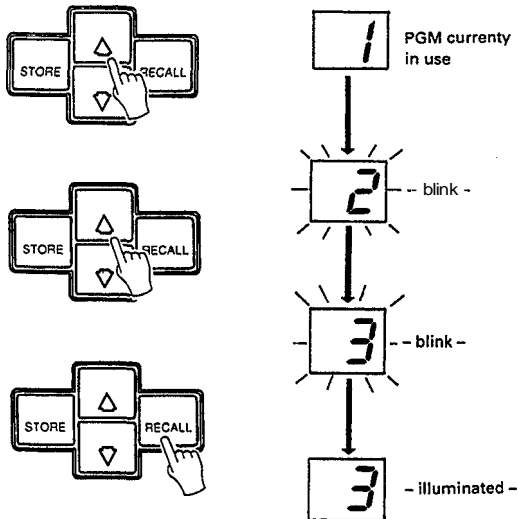

BYPASSING THE EFFECT

There are two ways to switch the selected effect in and out: 1) with the control panel BYPASS switch and 2) with a footswitch connected to the connector-panel BYPASS footswitch jack. An optional Yamaha FC5 Footswitch can be used for foot-bypass control. In either case + when the control-panel BYPASS key or BYPASS footswitch is pressed + the LED in the BYPASS key will light to indicate that the selected program is currently being bypassed and the input signal is directly routed to the output terminals (i.e. the effect is OFF). Press the BYPASS key or footswitch a second time to turn off the BYPASS Key LED and turn the effect back ON.

ACCESSING & EDITING THE PROGRAM PARAMETERS

Each SPX1000 program has 4 different groups of parameters which are accessed by pressing the corresponding parameter select keys:

KEY	ACCESSES
PARAM	The main effect parameters for each program. These parameters will vary according to the type of program.
LEVEL	The BALANCE and OUT LVL parameters for each program.
EQ	The equalization or dynamic filter parameters for each program.
INT. PARAM.	Special "fine control" parameters for each program. These parameters will vary according to the type of program.

To call a specific group of parameters for the currently selected effect program, press the appropriate parameter select key. The next parameter within the group is called each time the parameter select key for that group is pressed. In any parameter group, the SCROLL BACK key can be used to scroll backwards through the parameters. For example, subsequent presses on the LEVEL parameter select key call the following parameters:

BALANCE -> OUT LVL -> BALANCE -> etc.

The complete procedure for calling and editing parameters is:

- Select and recall the program to be edited.
- Press the parameter select key corresponding to the group of parameters to be edited (PARAM, LEVEL, EQ or INT PARAM) and the first of the selected group's parameters will appear on the bottom line of the LCD.
- Once the desired parameter has been called, its value can be edited using the parameter Δ and ∇ keys. The Δ key increases (increments) the value while the ∇ key decreases (decrements) the value. Either key can be held down for continuous incrementing or decrementing. While holding down either the Δ or ∇ key, pressing the other key (Δ or ∇) causes the incrementing or decrementing process to be carried out more rapidly.

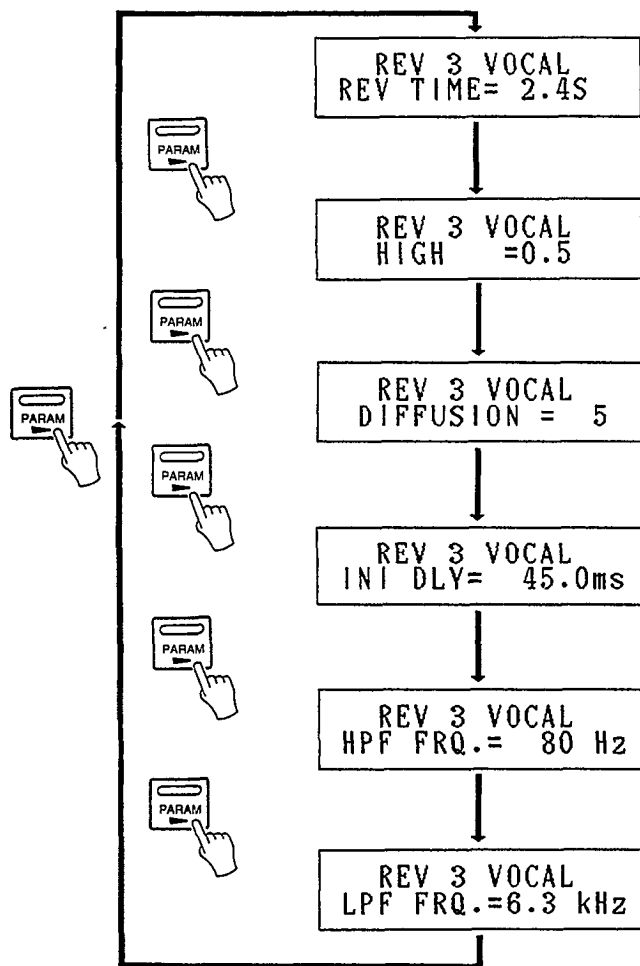

In this way you can go through and edit any number of the parameters to create the required effect. If, however, you select and recall a new program without first storing your edited parameters in a memory location between 41 and 99, any changes you have made will be lost and will have to be re-programmed. If you want to keep an edited program, use the STORE operation described below.

STORING EFFECTS

In order to store an edited effect for later recall you need to do the following:

1. Make sure that the SPX1000 MEMORY PROTECT function is OFF. Press the UTILITY key a few times until the MEMORY PROTECT function appears. If it is ON, press the parameter ∇ key to turn it OFF. Press and hold the UTILITY key until its indicator goes out and the utility mode is exited.
2. After editing the effect, select a memory location between 41 and 99 by using the program select Δ and ∇ keys. Do not recall the selected memory location. If an edited program has previously been stored in the selected memory location, its title will be displayed on the LCD.

3. Press the STORE key to store the edited effect in the selected memory location. The title of the effect stored will appear on the LCD (this may later be edited to create your own effect title using the UTILITY mode TITLE EDIT function described on page 31). The LED memory number display will stop flashing and the stored memory location will become the active effect.

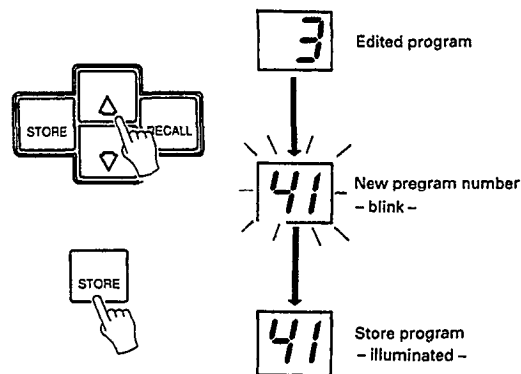

NOTE:

You CANNOT store edited data to memory locations 1 through 40. If you attempt to do this the LCD will show "*** READ ONLY ***".

NOTE:

Once an effect has been stored in a memory location between 41 and 99, its parameters can be further edited in the new memory location. Such changes will be lost if a different effect is selected and recalled, however, unless the STORE function is used to store the changes. Changes may be stored to the current memory location number (41 - 99) simply by pressing the STORE key.

EXTERNAL CONTROL ASSIGNMENT

The SPX1000 allows two different parameters of a selected effect to be controlled by optional foot controllers (Yamaha FC7) connected to the front-panel EXT CTRL/FOOT VOL1 and 2 jacks. The EXT CTRL ASSIGN key is used to assign the desired effect parameters to the foot controllers used, and to set the required control range. External control assignments made for an effect program can be stored in the user memory area (41 - 99) along with the effect (using the STORE function described above), so that the assignments made are recalled whenever that memory location is selected.

1. Select the desired effect program.
2. Select the parameter to be assigned to an external foot controller (PARAM, LEVEL, EQ or INT PARAM parameters can be assigned).
3. Press the EXT CTRL ASSIGN key. The name of the selected effect program will remain on the upper line of the LCD, and one of the following parameters will appear on the lower line:

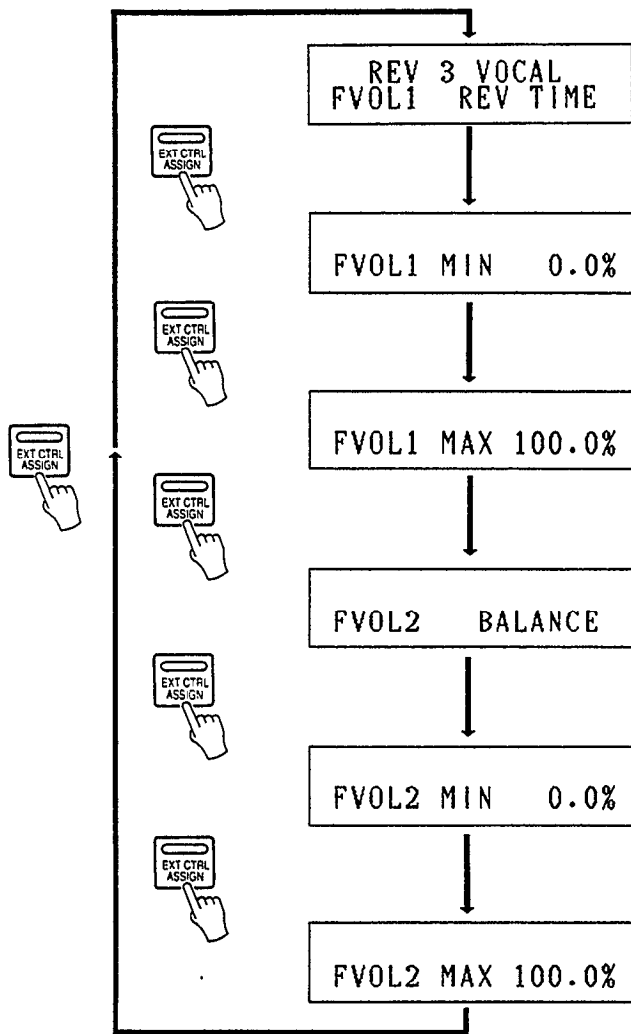

In the actual display, “XXXXXXXX” will be the name of the default parameter for the selected effect program. The EXT CTRL ASSIGN key can be used to scroll forward through the above parameters, and the SCROLL BACK key can be used to scroll backwards.

4. To assign the selected parameter to the EXT CTRL/FOOT VOL 1 or EXT CTRL/FOOT VOL 2 controller, use the EXT CTRL ASSIGN or SCROLL BACK key to call the “FVOL1 XXXXXXXX” or “FVOL2 XXXXXXXX” parameter.
5. Press either the parameter Δ or ∇ key and the parameter you called within the selected effect program will be assigned to the foot controller indicated on the display (FVOL 1 or FVOL 2).

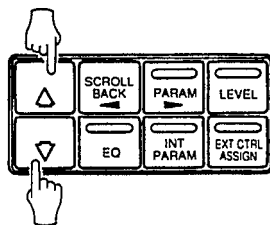

6. Use the “MIN” and “MAX” parameters for the appropriate controller to set the control range. If the parameter to be controlled has a range of 0 to 100%, for example, setting the MIN parameter to 20 and the MAX parameter to 80 will allow the foot controller to vary the selected parameter from 20% to 80% of its total range.

NOTE:
 Either or both controllers may be assigned. When both controllers are used, each can be assigned a different parameter within the selected effect program.

NOTE:
 External control assignments will be lost if a different memory location is selected without first storing the assigned effect program into one of the user memory locations (41 — 99) using the STORE function..

NOTE:
 MIDI control change messages received via the MIDI IN connector can also be used to control assigned parameters. See “MIDI CTRL ASSIGN” on page 63.

CAUTION!
 When setting the range and storing it in the program, always make sure the preset values for the assigned parameters are included within the set range. When setting the range, confirm the values for MIN and MAX with the controller, and always make sure the preset values are inside the externally set values. If the preset values are outside the specified range, there may be no response to the controller when a recall operation is carried out.

4: THE PROGRAMS & PARAMETERS

PARAMETERS PROVIDED FOR ALL PROGRAMS

LEVEL PARAMETERS (Accessed via LEVEL key)

Effect/Direct Signal Balance (BALANCE): 0 – 100%

This parameter adjusts the balance between the direct sound and effect signals. At 100% only the effect sound is delivered from the SPX1000 outputs, while at 0% only the direct sound is output. At a setting of 50%, the direct and effect sounds are output in approximately equal proportions.

Effect Output Level (OUT LVL): 0 – 200%

This parameter sets the overall output level of the effect program. This is particularly handy for matching levels between different effects.

2-CHANNEL PROGRAM (PROGRAMS 31 – 35) LEVEL PARAMETERS

The level parameters available for the 2-channel programs (programs 31 – 35) are the same as those for the other programs, except that separate parameters are provided for the left and right channels.

BALANCE 1 = 1 (Left)-channel Balance

BALANCE 2 = 2 (Right)-channel Balance

OUT LVL 1 = 1 (Left)-channel Output Level

OUT LVL 2 = 2 (Right)-channel Output Level

EQ PARAMETERS (Accessed via EQ key)

When the EQ key is pressed, you are presented with three choices: "OFF" (the default setting), "EQ" (2-band parametric equalizer mode), or "D.FLT" (Dynamic Filter mode). Use the parameter Δ and ∇ keys to select the desired mode of operation. The EQ mode provides 2-band parametric equalization, while the Dynamic Filter mode provides a filter which can be automatically swept across a specified frequency range by the SPX1000's internal low frequency oscillator or the level of the input signal.

● PARAMETERS AVAILABLE IN THE "EQ" MODE

**Low EQ Peaking or Shelving Response (LOW EQ.):
PEAK, SHLV**

**High EQ Peaking or Shelving Response (HIGH EQ):
PEAK, SHLV**

These parameters determine whether the corresponding band has a peaking or shelving filter response.

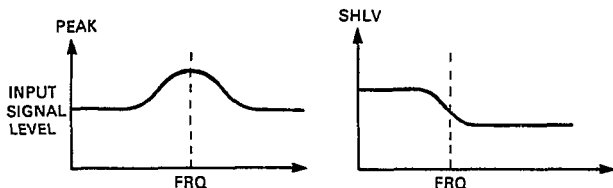

Low EQ Frequency (LOW FRQ): 32 Hz – 2.2 kHz

High EQ Frequency (HIGH FRQ): 500 Hz – 16 kHz

These parameters determine the center frequency for equalization in the corresponding band. In the shelving mode, these parameters represent the turn over frequency rather than the center frequencies.

Low EQ Gain (LOW GAIN): -15 – + 15 dB

High EQ Gain (HIGH GAIN): -15 – + 15 dB

These parameters determine the amount of boost or cut applied to the corresponding EQ band.

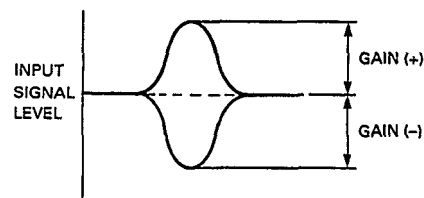

Low EQ Bandwidth (LOW Q): 0.1 – 5.0 (PEAK mode only)

High EQ Bandwidth (HI Q): 0.1 – 5.0 (PEAK mode only)

These parameters determine the bandwidth of the corresponding EQ band. A setting of 5.0 produces the narrowest bandwidth (sharpest response), and the minimum setting of 0.1 produces the widest bandwidth (broadest response). Note that the "Q" parameters for the low and high bands only function when the corresponding band is set to the PEAK mode.

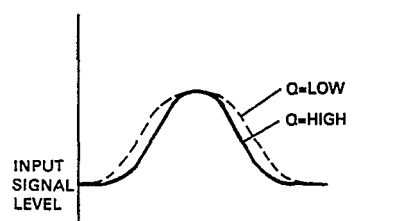

● PARAMETERS AVAILABLE IN THE "D.FLT" MODE

Control Type (CTL TYPE): LFO, LEVEL

Determines whether the sweep of the dynamic filter is controlled by the SPX1000's LFO (Low Frequency Oscillator) or the level of the input signal to analog trigger.

Filter Type (FLT TYPE): LPF, HPF, BPF, PEQ

Determines the response of the dynamic filter:

- LPF = Low Pass Filter
- HPF = High Pass Filter
- BPF = Band Pass Filter
- PEQ = Parametric EQ

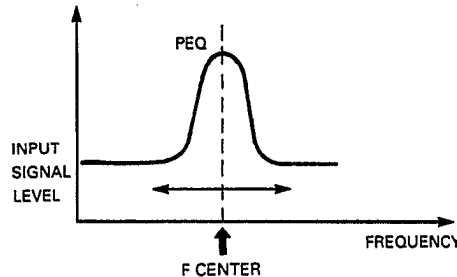
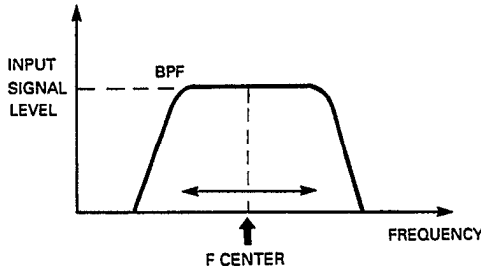
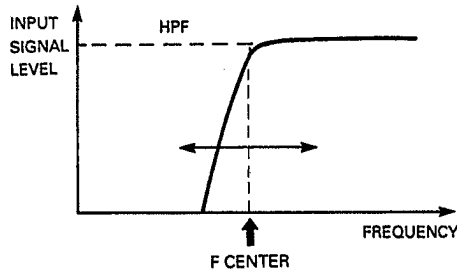
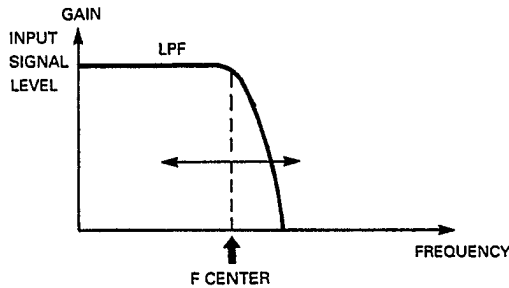

Center Frequency (F CENTER): 32 Hz – 16 kHz

Sets the starting center frequency of the dynamic filter.

Frequency Depth (F DEPTH): 0 – 8 octaves

Determines the maximum sweep range of the dynamic filter.

Filter Gain (GAIN): -18, -12, -6, 6, 12, 18 dB (when FLT TYPE = PEQ only)

Determines the gain of the dynamic filter when the PEQ filter type is selected. Minus values create a notch response while positive values create a peaking response.

Bandwidth (Q): LOW, HIGH

Sets the bandwidth of the dynamic filter.

Filter Shift Direction (SHIFT): UP, DOWN

Determines which direction the dynamic filter will sweep in from the starting point.

Filter Sensitivity (SENSITIVITY): 1 – 10

Adjusts the sensitivity of the dynamic filter. Higher settings create a greater degree of sweep for the same change in input level (LEVEL control type).

Filter Decay (DECAY): 1 – 10

Determines the speed at which the dynamic filter will return to the starting frequency after activation.

Low Frequency Oscillator Frequency (LFO FRQ): 0.1 – 10.0 Hz

Sets the LFO frequency and thus the speed of dynamic filter sweep when the LFO control type is selected.

2-CHANNEL PROGRAM (PROGRAMS 31 – 35) EQ PARAMETERS

The EQ parameters for the 2-channel programs (programs 31 – 35) are the same as for the other programs, except that separate EQ parameters are provided for the left and right channels when the “EQ” mode is selected.

- L LOW EQ = Left-channel Low EQ
- L LOW F = Left-channel Low Frequency
- L LOW G = Left-channel Low Gain
- L LOW Q = Left-channel Low Bandwidth
- L HI EQ = Left-channel High EQ
- L HI F = Left-channel High Frequency
- L HI G = Left-channel High Gain
- L HI Q = Left-channel High Bandwidth
- R LOW EQ = Right-channel Low EQ
- R LOW F = Right-channel Low Frequency
- R LOW G = Right-channel Low Gain
- R LOW Q = Right-channel Low Bandwidth
- R HI EQ = Right-channel High EQ
- R HI F = Right-channel High Frequency
- R HI G = Right-channel High Gain
- R HI Q = Right-channel High Bandwidth

REVERB PROGRAMS

- 1. REV1 HALL
- 2. REV2 ROOM
- 3. REV3 VOCAL
- 4. REV4 PLATE
- 5. REV5 ECHO ROOM

Reverberation is the warm musical “ambience” you experience when listening to music in a hall or other properly-designed acoustic environment. The SPX1000 offers several different reverb effects, simulating types of reverberation you would experience in a hall (REV 1 HALL), in a smaller room (REV 2 ROOM), a reverb effect ideally suited to vocals (REV 3 VOCAL), the type of reverberation produced artificially by

a plate reverberator (REV 4 PLATE), and a special echo room (REV 5 ECHO ROOM) in which you have extensive control over the room's dimensions and other parameters.

PARAMETERS ACCESSED BY THE PARAM KEY

(Except 5. REV5 ECHO ROOM)

Reverb Time (REV TIME):

0.3 – 480 seconds (1 REV1 HALL, 3 REV3 VOCAL)

0.1 – 480 seconds (2 REV2 ROOM, 4 REV4 PLATE)

The length of time it takes for the level of reverberation at 1 kHz to decrease by 60 dB + virtually to silence. In a live setting, this depends on several factors: room size, room shape, type of reflective surfaces, and others.

High Frequency Reverb Time Ratio (HIGH): 0.1 – 1.0

Natural reverberation varies according to the frequency of the sound. The higher the frequency, the more sound tends to be absorbed by walls, furnishings and even air. These two parameters allow alteration of the high-frequency and low-frequency reverb times in relation to the overall reverb time.

Diffusion (DIFFUSION): 0 – 10

The complexity of the many reflections that make up reverberation varies according to the shape of the room and its contents. In the SPX1000 the term "diffusion" refers to the complexity of these reflections. If the DIFFUSION parameter is set to "0," minimum complexity and therefore a clearer, more straightforward reverb effect is produced. As the DIFFUSION value is increased, the complexity of the reflections increases producing a thicker, richer sound.

Initial Delay (INI DLY): 0.1 – 1000 milliseconds

This represents the time delay between the direct sound of an instrument in a concert hall and the first of the many reflections that make up reverberation.

High-pass Filter Frequency (HPF FRQ): THRU, 32 Hz – 1 kHz

Permits rolling off the low-frequency content of the reverb signal above the set frequency. The HPF is OFF when set to THRU.

Low-pass Filter Frequency (LPF FRQ): 1 – 16 kHz, THRU

Permits rolling off the high-frequency content of the reverb signal above the set frequency. The LPF is OFF when set to THRU.

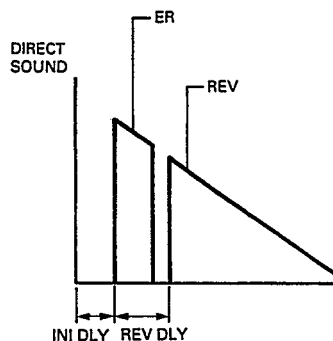

■ 5. REV5 ECHO ROOM

Reverb Time (REV TIME): 0.3 – 480 seconds

The length of time it takes for the level of reverberation at 1 kHz to decrease by 60 dB + virtually to silence. In a live setting, this depends on several factors: room size, room shape, type of reflective surfaces, and others.

Room Width (WIDTH): 0.5 – 100.0 meters

Room Height (HEIGHT): 0.5 – 100.0 meters

Room Depth (DEPTH): 0.5 – 100.0 meters

These parameters make it possible to specify the main dimensions of the echo room in meters. Basically, the larger the dimensions of the room the longer the reverb sound.

Wall Variance (WALL VARY): 0 – 30

Irregularity factor refers to the relationship of the wall surfaces in the echo room. At a setting of 1 all walls are parallel. Higher settings increase the angles between the wall surfaces, causing a distinct change in the reverb sound.

Listening Position (LIS. POSI.): FRONT, CENT., REAR

Allows position the "listener" to the front, center or rear of the echo room in relation to the source sound.

High Frequency Reverb Time Ratio (HIGH): 0.1 – 1.0

Natural reverberation varies according to the frequency of the sound. The higher the frequency, the more sound tends to be absorbed by walls, furnishings and even air. These two parameters allow alteration of the high-frequency and low-frequency reverb times in relation to the overall reverb time.

Diffusion (DIFFUSION): 0 – 10

The complexity of the many reflections that make up reverberation varies according to the shape of the room and its contents. In the SPX1000 the term "diffusion" refers to the complexity of these reflections. If the DIFFUSION parameter is set to "0," minimum complexity and therefore a clearer, more straightforward reverb effect is produced. As the DIFFUSION value is increased, the complexity of the reflections increases producing a thicker, richer sound.

Initial Delay (INI DLY): 0.1 – 1000 milliseconds

This represents the time delay between the direct sound of an instrument in a concert hall and the first of the many reflections that make up reverberation.

High-pass Filter Frequency (HPF FRQ): THRU, 32 Hz – 1 kHz

Low-pass Filter Frequency (LPF): 1 – 16 kHz, THRU

Same as other reverbs.

Width fine: -100 – +100

This sets the value specified with WIDTH as the reference value (0) and is the parameter for fine adjustment.

Height Fine: -100 – +100

This sets the value specified with HEIGHT as the reference value (0) and is the parameter for further fine adjustment.

Depth Fine: -100 – +100

This sets the value specified with DEPTH as the reference value (0) and is the parameter for further fine adjustment.

Wall Vary Fine (W. VARY FINE): -100 – +100

This sets each of the value specified with WIDTH, HEIGHT, DEPTH, and WALL VARY as the reference value (0) and is the parameter for further fine adjustment.

W. Decay: $RT \times 0.1 - 1.0$

Among the REV components, this sets the reverberation time of the REV components specified with WIDTH to a multiplier value corresponding to the REV TIME. It simulates the acoustic properties of the side walls.

H. Decay: $RT \times 0.1 - 1.0$

D. Decay: $RT \times 0.1 - 1.0$

In the same way as for W. Decay, this sets a multiplier value corresponding to REV TIME for reverberation time felt in relation to the HEIGHT (vertical direction) in the height direction and that felt for the DEPTH in the front-to-back direction. It also simulates the acoustic properties of the walls in the vertical and front-to-back directions.

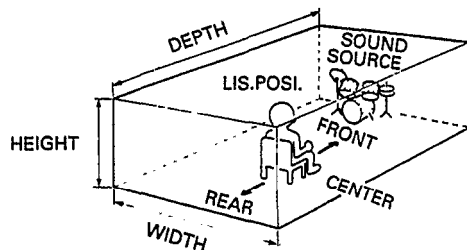

PARAMETERS ACCESSED BY THE INT PARAM KEY

Early Reflection/Reverb Balance (ER/REV BAL.): 0 – 100%

This parameter determines the level balance between the early-reflection portion and final reverberation portion of the reverb sound. At 100% only the early-reflection sound will be produced. At 0% only the final reverberation sound will be produced. A setting of about 50% produces both the early-reflection and final reverberation sounds at equal level.

Reverb Delay (REV DLY): 0.1 – 300.0 milliseconds

Sets the delay between the beginning of the early reflections – the initial group of sparse reflections that precede the dense reverb sound – and the beginning of the reverb sound.

Density (DENSITY): 0 – 4

This parameter determines the density of the reverb reflections (i.e. the average amount of time between reflections). A setting of 1 produces minimum reverb density for a more spacious sound, while a setting of 4 produces the most dense, “tightest” reverberation.

Trigger Level (TRG. LEVEL): 0 – 100%

Determines the level of the input signal required to trigger “opening” of the reverb program gate. At 100% only very high-level input signals will trigger the gate, while at 1% even the tiniest input signal will trigger the gate.

Trigger Delay (TRG. DLY): -100 – +100 milliseconds

Produces a delay between the time at which the gate is triggered and that at which it actually opens.

Hold Time (HOLD): 1 – 24,000 milliseconds

Determines how long the gate stays open, allowing the signal to pass.

Release Time (RELEASE): 3 – 24,000 milliseconds

Determines how long it takes for the gate to close fully after the HOLD TIME has ended.

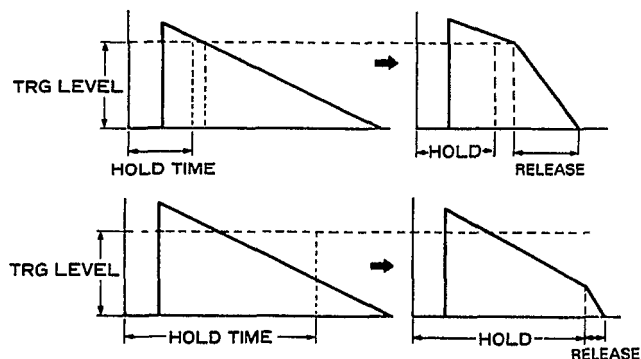

Analog Trigger Level (A. TRG LVL): 0 – 100

When an analog signal applied to the rear-panel TRIGGER 2 ANALOG jack is used to trigger the gate, this parameter determines the level of the input signal required to trigger “opening” of the reverb program gate. At 100% only very high-level input signals will trigger the gate, while at 1% even the tiniest input signal will trigger the gate. When this function is used the TRG. LEVEL parameter should be set to the highest value (100%) so that only signals applied to the TRIGGER 2 ANALOG jack will activate the gate.

MIDI Trigger (MIDI TRG.): OFF, ON

When this parameter is turned ON, a KEY ON EVENT message from an external MIDI keyboard can be used to trigger the gate. A KEY ON EVENT message is transmitted whenever a note on a MIDI keyboard is played.

NOTE:

This effect can also be triggered by the front-panel TRIGGER key or a footswitch plugged into the rear-panel TRIGGER 1 SW jack.

EARLY REFLECTION PROGRAMS

- 6. EARLY REF. 1
- 7. EARLY REF. 2
- 8. EARLY REF. 3
- 9. GATE REVERB
- 10. REVERSE GATE

These effects are created using different groupings of “early reflections” – the first cluster of reflections that occurs after the direct sound but before the dense reflections that are known as reverberation begin.

PARAMETERS ACCESSED BY THE PARAM KEY

Early Reflection Pattern Type (TYPE):

EARLY REF. 1 & 2: S-HALL, L-HALL, RANDOM, REVERSE, PLATE, SPRING

EARLY REF. 3: USER-A, USER-B, USER-C, USER-D

GATE REVERB & REVERSE GATE: TYPE A, TYPE B

In the EARLY REF. 1 and EARLY REF. 2 programs the TYPE parameter selects one of six different patterns of early reflections. S-HALL produces a typical grouping of early reflections that would occur in a performing environment such as a small hall. L-HALL simulates the early reflection pattern of a larger hall. RANDOM produces an irregular series of reflections that could not occur naturally. REVERSE generates a series of reflections that increase in level – like the effect produced by playing a recorded reverberation sound backwards. PLATE produces a typical grouping of reflections that would occur in a plate reverb unit, and SPRING produces the same for spring type reverb unit.

In the EARLY REF. 3 program the TYPE parameter selects one of the four user-programmed early reflection patterns: USER-A, USER-B, USER-C or USER-D. The USER early reflection patterns are programmed using the utility-mode “USER ER EDIT” function (see “USER ER EDIT” on page 31 for details).

In the GATE REVERB and REVERSE GATE programs the TYPE parameter selects either TYPE-A or TYPE-B.

Room Size (ROOM SIZE): 0.1 – 25

This parameter sets the time intervals between the early reflections + a feature of natural early reflections which is directly proportional to the size of the room.

Liveness (LIVENESS): 0 – 10

“Liveness” refers to the rate at which the reflected sounds fade. An acoustically “dead” room is simulated by setting this parameter to zero. Increasing the value of this parameter creates an increasingly “live” sound, simulating an increasing area of reflective surfaces in the room.

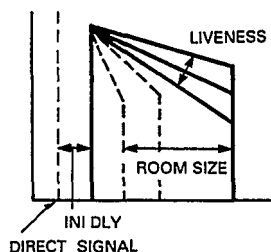

Diffusion (DIFFUSION): 0 – 10

The complexity of the many reflections that make up reverberation varies according to the shape of the room and its contents. In the SPX1000 the term “diffusion” refers to the complexity of these reflections. If the DIFFUSION parameter is set to “0,” minimum complexity and therefore a clearer, more straightforward early reflection effect is produced. As the DIFFUSION value is increased, the complexity of the reflections increases producing a thicker, richer sound.

Initial Delay (INI DLY): 0.1 – 1000 milliseconds

Initial delay is the time between the beginning of the direct sound and the beginning of the early reflections.

High-pass Filter Frequency (HPF FRQ): THRU, 32 Hz – 1 kHz

Permits rolling off the low-frequency content of the reverb signal above the set frequency. The HPF is OFF when set to THRU.

Low-pass Filter Frequency (LPF FRQ): 1 – 16 kHz, THRU

Permits rolling off the high-frequency content of the reverb signal above the set frequency. The LPF is OFF when set to THRU.

PARAMETERS ACCESSED BY THE INT PARAM KEY

Number of Early Reflections (ER NUMBER): 1 – 19

This parameter directly sets the number of early reflections produced from 1 to 19.

Feedback Delay (FB DELAY): 0.1 – 26000 milliseconds

Feedback Gain (FB GAIN): -99 – +99%

Feedback High-frequency Ratio (FB HIGH): 0.1 – 1.0

The feedback parameters permit thickening and/or extending the early reflection sound. Feedback causes the early reflections to generate more early reflections of themselves, thus the FB GAIN parameter determines how many times (for how long) the early reflections are repeated. The FB DELAY parameter sets a delay time between the beginning of the original early-reflections and the first of the repeats caused by feedback. Shorter FB DELAY times simply thicken the early-reflection sound, while longer FB DELAY times can create extended or repeated early reflection effects. FB HIGH determines how much of the high-frequency content of the original early reflections is fed back. The lower the setting, the less of the original high frequencies are fed back. This causes a gradual decrease in high frequency content at each repeat.

Density (DENSITY):

EARLY REF. 2: 1 – 3

EARLY REF. 3, GATE REVERB, REVERSE GATE:

0–3

Please note that the DENSITY parameter is not provided in the EARLY REF. 1 program. This parameter determines the density of the reverb reflections (i.e. the average amount of time between reflections). A setting of 0 or 1 produces minimum reverb density for a more spacious sound, while a setting of 3 produces the most dense, “tightest” reverberation.

DELAY PROGRAM

■ 11. DELAY L,C,R

This sophisticated delay effect offers independently variable left, right and center channel delays.

PARAMETERS ACCESSED BY THE PARAM KEY

Left Channel Delay (Lch DLY): 0.1 – 5200 milliseconds

Right Channel Delay (Rch DLY): 0.1 – 5200 milliseconds

Center Channel Delay (Cch DLY): 0.1 – 5200 milliseconds

These parameters individually set the time between the direct sound of the instrument and the first repeat heard from the left, right and center channels.

Center Channel Level (Cch LVL): -200 – +200%

Adjusts the level of the center-channel delay signal.

PARAMETERS ACCESSED BY THE INT PARAM KEY

High-pass Filter Frequency (HPF FRQ): THRU, 32 Hz – 1 kHz

Permits rolling off the low-frequency content of the reverb signal above the set frequency. The HPF is OFF when set to THRU.

Low-pass Filter Frequency (LPF FRQ): 1 – 16 kHz, THRU

Permits rolling off the high-frequency content of the reverb signal above the set frequency. The LPF is OFF when set to THRU.

Feedback 1 Delay (FB1 DLY): 0.1 – 5200 milliseconds

Feedback 2 Delay (FB2 DLY): 0.1 – 5200 milliseconds

Two separate feedback loops are provided in the delay program, and these parameters determine the amount of delay applied to each feedback signal.

Feedback 1 Gain (FB1 GAIN): -99% – +99%

Feedback 2 Gain (FB2 GAIN): -99% – +99%

Set the amount of delay signal fed back to the input of the processor. The higher the feedback gain setting, the greater the number of delayed repeats produced by the corresponding feedback loop.

High Frequency Feedback (HIGH): x0.1 – x1.0

Controls feedback in the high-frequency range. The high-frequency feedback is reduced as the value of this parameter is decreased.

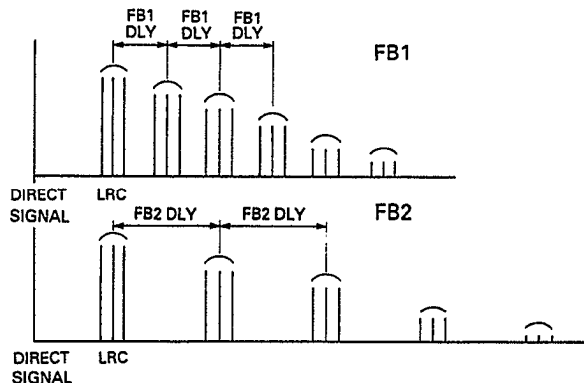
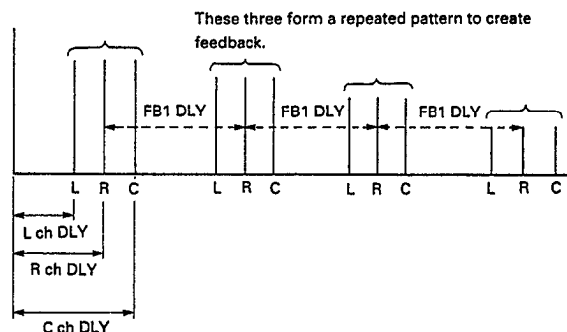
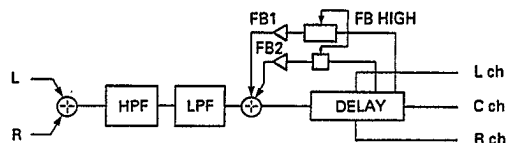

ECHO PROGRAM

■ 12. STEREO ECHO

The stereo echo effect offers independently variable left and right channel initial delays and echo intervals.

PARAMETERS ACCESSED BY THE PARAM KEY

Left Channel Feedback Delay (LFB DLY): 0.1 – 2600 milliseconds

Right Channel Feedback Delay (RFB DLY): 0.1 – 26000 milliseconds

After the initial delay produced by the INI DLY parameters, the time between subsequent repeats is determined by the left and right channel interval parameters.

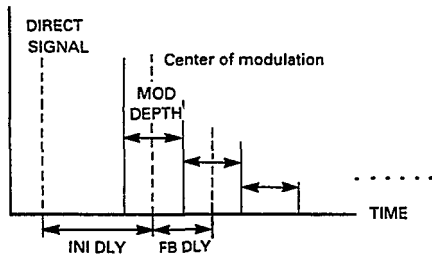

Left Channel Feedback Gain (Lch F.B): -99% — +99%
Right Channel Feedback Gain (Rch F.B): -99% — +99%

Individually set the amount of the left or right channel delay signal fed back to the input of the processor. The higher the feedback gain setting, the greater the number of delayed repeats produced for the corresponding channel.

High Frequency Feedback (HIGH): x0.1 — x1.0

Controls feedback in the high-frequency range. The high-frequency feedback is reduced as the value of this parameter is decreased.

PARAMETERS ACCESSED BY THE INT PARAM KEY

Left Channel Initial (L INI DLY): 0.1— 2600 milliseconds

Right Channel Initial (R INI DLY): 0.1— 2600 milliseconds

These parameters individually set the time between the direct sound of the instrument and the first repeat heard from the left and right channels.

High-pass Filter Frequency (HPF FRQ): THRU, 32 Hz — 1.0 kHz

Permits rolling off the low-frequency content of the reverb signal above the set frequency. The HPF is OFF when set to THRU.

Low-pass Filter Frequency (LPF FRQ): 1 — 16 kHz, THRU

Permits rolling off the high-frequency content of the reverb signal above the set frequency. The LPF is OFF when set to THRU.

MODULATION PROGRAMS

- 13. STEREO FLANGE A
- 14. STEREO FLANGE B
- 15. CHORUS
- 16. STEREO PHASING
- 17. TREMOLO
- 18. SYMPHONIC

The stereo flange effects produce a pleasant "swirling" sound which can effectively thicken and add warmth to the sound of an instrument. The flanging effect is produced by varying the delay between two identical signals, thus producing a complex varying "comb filter" effect.

Phasing is basically a "gentler" version of the flange effect, lending a smooth, animated quality to the original sound.

The tremolo effect is produced in the same way as the flange effect, but has a "bigger," more sweeping sound. The symphonic effect adds richness and life to the sound.

PARAMETERS ACCESSED BY THE PARAM KEY

Please note that STEREO PHASING does not have the F.B GAIN parameter listed below, while TREMOLO and SYMPHONIC have only the MOD FRQ and MOD DEPTH parameters.

Modulation Frequency (MOD. FRQ): 0.05 Hz — 40 Hz

Sets the speed of modulation, and hence the rate at which the effect varies.

Modulation Depth (1, 2) (MOD. DEPTH): 0% — 100%

Sets the amount of delay time variation, thus adjusting the depth of the effect.

Modulation Delay (1, 2) (MOD. DLY): 0.1— 100 milliseconds

This sets the basic delay time from the initial direct sound to the beginning of the flange effect.

Feedback Gain (F.B. GAIN): 0% — 99%

Determines the amount of flange signal which is fed back to the input of the processor for further modulation. More feedback increases the overall complexity, "strength" and decay time of the effect.

Phase (PHASE): -180.0 deg — +180.0deg

(14. STEREO FLANGE B) Sets the phase between MOD. DLY1 and 2.

Delay Time Modulation Depth (DM DEPTH): 0% — 100%

(15. CHORUS) Sets the amount of the width of the shaking between L and R channel.

Amplitude Modulation Depth (AM DEPTH): 0% — 100%

(15. CHORUS) Sets the amount of the width of amplitude variation.

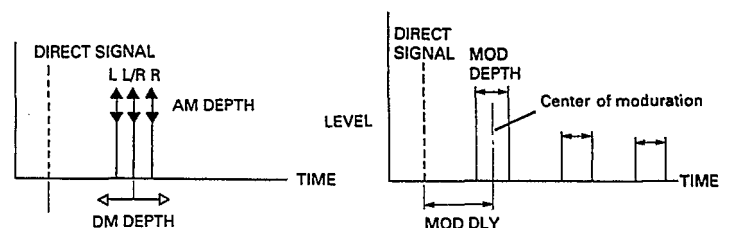

PARAMETERS ACCESSED BY THE INT PARAM KEY

High-pass Filter Frequency (HPF FRQ): THRU, 32 Hz – 1.0 kHz

Permits rolling off the low-frequency content of the reverb signal above the set frequency. The HPF is OFF when set to THRU.

Low-pass Filter Frequency (LPF FRQ): 1 – 16 kHz, THRU

Permits rolling off the high-frequency content of the reverb signal above the set frequency. The LPF is OFF when set to THRU.

NOISE GATE

19. ADR-NOISE GATE

This program uses a “gate” to pass or shut off the input signal in a number of ways. It can be used to pass just a short segment of a longer input signal, or it can be set up to pass only signals that exceed a specified level. In the latter case this program functions as a “noise gate.” It is also possible to create reverse gate type effects in which the gain increases gradually after the effect is triggered.

PARAMETERS ACCESSED BY THE PARAM KEY

Trigger Level (TRG. LEVEL): 0 – 100%

Determines the level of the input signal required to trigger “opening” of the gate. At 100% only very high-level input signals will trigger the gate, while at 0% even the tiniest input signal will trigger the gate.

Trigger Delay (TRG. DLY): -100 – +100 milliseconds

Produces a delay between the time at which the gate is triggered and that at which it actually opens. If a minus value is programmed, the input signal is delayed so that, effectively, the gate opens before the signal appears.

Trigger Mask (TRG. MSK): 3 – 24000 milliseconds

This parameter makes it impossible to re-trigger the gate function until the programmed time has elapsed.

Attack Time (ATTACK): 3 – 24000 milliseconds

Determines how long it takes for the gate to open fully from the time it begins to open.

Decay Time (DECAY): 3 – 24000 milliseconds

Determines the length of time it takes for the gate envelope to fall to DECAY LEVEL after it is fully open.

Decay Level (DECAY LVL): 0 – 100%

Determines the level at which the gate remains open for the HOLD TIME. The lower the value, the lower the HOLD gate level.

Hold Time (HOLD): 1 – 24000 milliseconds

Determines how long the gate stays open, allowing the signal to pass at the DECAY LEVEL, after the first decay and prior to beginning of the RELEASE TIME.

Release Time (RELEASE): 3 – 24000 milliseconds

Determines how long it takes for the gate to close fully after the HOLD TIME has ended.

Analog Trigger Level (A. TRG LVL): 0 – 100%

When an analog signal applied to the rear-panel TRIGGER 2 ANALOG jack is used to trigger the gate, this parameter determines the level of the input signal required to trigger “opening” of the gate. At 100% only very high-level input signals will trigger the gate, while at 1% even the tiniest input signal will trigger the gate. When this function is used the TRG. LEVEL parameter should be set to the highest value (100%) so that only signals applied to the TRIGGER 2 ANALOG jack will activate the gate.

MIDI Trigger (MIDI TRG.): OFF, ON

When this parameter is turned ON, a KEY ON EVENT message from an external MIDI keyboard can be used to trigger the gate. A KEY ON EVENT message is transmitted whenever a note on a MIDI keyboard is played.

NOTE:

This effect can also be triggered by the front-panel TRIGGER key or a footswitch plugged into the rear-panel TRIGGER 1 SW jack.

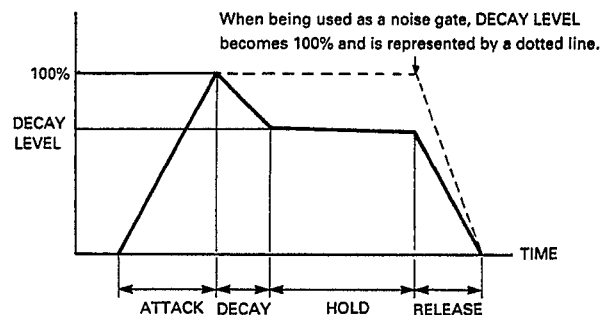

PARAMETERS ACCESSED BY THE INT PARAM KEY

High-Pass Filter Frequency (HPF FRQ): THRU, 32 Hz – 1.0 kHz

Low-Pass Filter Frequency (LPF FRQ): 1 – 16 kHz, THRU

PITCH CHANGE TYPE PROGRAMS

- 20. PITCH CHANGE 1
- 21. PITCH CHANGE 2
- 22. PITCH CHANGE 3
- 39. STEREO PITCH

PARAMETERS ACCESSED BY THE PARAM KEY

■ 20. PITCH CHANGE 1

PITCH CHANGE 1 makes it possible to produce two independently pitch-shifted output notes in addition to the direct signal, so you can create three-part harmonies with a single input note. Both pitch-shifted notes appear at the center of the stereo sound field.

1st Pitch Shift (1 PITCH): -24 – +24

2nd Pitch Shift (2 PITCH): -24 – +24

Set the pitch of the first or second pitch-shifted note between two octaves below (-24) and two octaves above (+24) the input note.

1st Fine Tuning (1 FINE): -100 – +100

2nd Fine Tuning (2 FINE): -100 – +100

Permit fine tuning of the first or second pitch-shifted note in 1-cent steps.

1st Delay Time (1 DLY): 0.1 – 2300 milliseconds

2nd Delay Time (2 DLY): 0.1 – 2300 milliseconds

Determines the time delay between input of the original note and output of the first or second pitch-shifted note.

1st Feedback Gain (1 F.B.): -99 – +99

2nd Feedback Gain (2 F.B.): -99 – +99

When this parameter is set to 0, only a single pitch-shifted sound is produced after the DELAY time has elapsed. As the value of this parameter is increased, however, more and more delayed repeats are produced, each pitch-shifted up or down from the previous repeat according to the setting of the PITCH parameter.

1st Level (1 LEVEL): 0 – 100%

2nd Level (2 LEVEL): 0 – 100%

These parameters determine the levels of the first and second pitch-shifted notes.

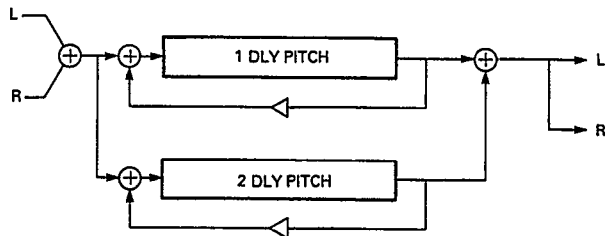

■ 21. PITCH CHANGE 2

Like the PITCH CHANGE 1 program, PITCH CHANGE 2 produces 2 pitch-shifted notes in addition to the original input note. In this program, however, the two pitch-shifted notes are independently fed to the left and right channel outputs (the direct sound is positioned at the center of the stereo sound field) for a true stereo harmony effect.

Left Pitch Shift (L PITCH): -24 – +24

Right Pitch Shift (R PITCH): -24 – +24

Set the pitch of the left or right channel pitch-shifted note between two octaves below (-24) and two octaves above (+24) the input note.

Left Fine Tuning (L FINE): -100 – +100

Right Fine Tuning (R FINE): -100 – +100

Permit fine tuning of the left or right channel pitch-shifted note in 1-cent steps.

Left Delay Time (L DLY): 0.1 – 2300 milliseconds

Right Delay Time (R DLY): 0.1 – 2300 milliseconds

Determine the time delay between input of the original note and output of the left or right channel pitch-shifted note.

Left Feedback Gain (L.F.B.): -99 – +99

Right Feedback Gain (R.F.B.): -99 – +99

When this parameter is set to 0, only a single pitch-shifted sound is produced after the DELAY time has elapsed. As the value of this parameter is increased, however, more and more delayed repeats are produced, each pitch-shifted up or down from the previous repeat according to the setting of the PITCH parameter.

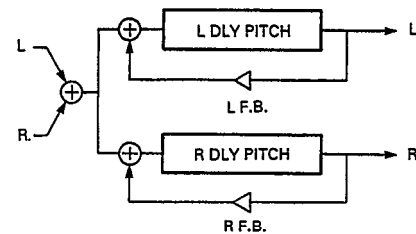

■ 22. PITCH CHANGE 3

PITCH CHANGE 3 offers the “thickest” and most complex sound by allowing the creation of three pitch-shifted notes in addition to the direct sound.

1st Pitch Shift (1 PITCH): -24 – +24

2nd Pitch Shift (2 PITCH): -24 – +24

3rd Pitch Shift (3 PITCH): -24 – +24

Set the pitch of the first, second or third pitch-shifted note between two octaves below (-24) and two octaves above (+24) the input note.

1st Fine Tuning (1 FINE): -100 – +100

2nd Fine Tuning (2 FINE): -100 – +100

3rd Fine Tuning (3 FINE): -100 – +100

Permit fine tuning of the first, second or third pitch-shifted note in 1-cent steps.

1st Delay Time (1 DLY): 0.1 – 4600 milliseconds

2nd Delay Time (2 DLY): 0.1 – 4600 milliseconds

3rd Delay Time (3 DLY): 0.1 – 4600 milliseconds

Determines the time delay between input of the original note and output of the first, second or third pitch-shifted note.

1st Level (1 LEVEL): 0 – 100%

2nd Level (2 LEVEL): 0 – 100%

3rd Level (3 LEVEL): 0 – 100%

These parameters determine the levels of the first, second and third pitch-shifted notes.

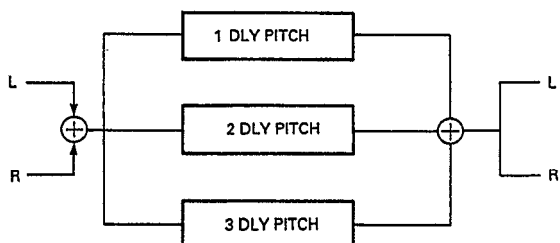

■ 39. STEREO PITCH

The STEREO PITCH program produces a smooth pitch shift effect rather than an abrupt shift from note to note. The parameters affect both the left and right channels simultaneously.

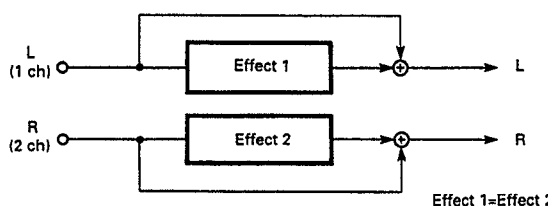

Pitch Shift (PITCH): -24 – +24

Set the pitch of the pitch-shifted note between two octaves below (-24) and two octaves above (+24) the input note.

Fine Tuning (PITCH FINE): -100 – +100

Permit fine tuning of the pitch-shifted note in 1-cent steps.

Delay Time (DELAY): 0.1 – 2300 milliseconds

Determine the time delay between input of the original note and output of the pitch-shifted note.

Feedback Gain (FB GAIN): -99 – +99

When this parameter is set to 0, only a single pitch-shifted sound is produced after the DELAY time has elapsed. As the value of this parameter is increased, however, more and more delayed repeats are produced, each pitch-shifted up or down from the previous repeat according to the setting of the PITCH parameter.

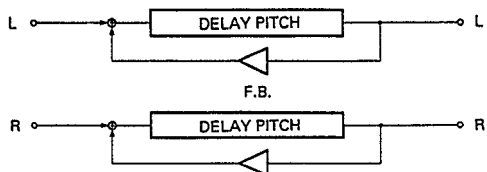

PARAMETERS ACCESSED BY THE INT PARAM KEY

Base Key (BASE KEY): OFF, C1 – C6

This parameter sets the “BASE KEY” for an external MIDI synthesizer used to control the PITCH parameter (the MIDI OUT terminal of the synthesizer must be connected to the SPX1000 MIDI IN terminal, and the SPX1000 must be set to receive on the MIDI channel on which the synthesizer is transmitting). If, for example, the BASE KEY parameter is set to C4, pressing the C3 key on the synthesizer (C3 is one octave lower than C4) will set the pitch change value to -12. Pressing D4 on the keyboard would produce a pitch increase of one whole-tone (+2). When two keys are pressed, the highest note determines the pitch of the 1 PITCH or L PITCH sound, and the lower note determines the pitch of the 2 PITCH or R PITCH sound. With the STEREO PITCH program the last note pressed takes priority. If a key more than two octaves higher or lower than the BASE KEY is pressed, the resultant pitch change setting will still be within the -24 to +24 range, as shown in the illustration below. If the BASE KEY parameter is set OFF, pitch cannot be controlled via the MIDI IN terminal.

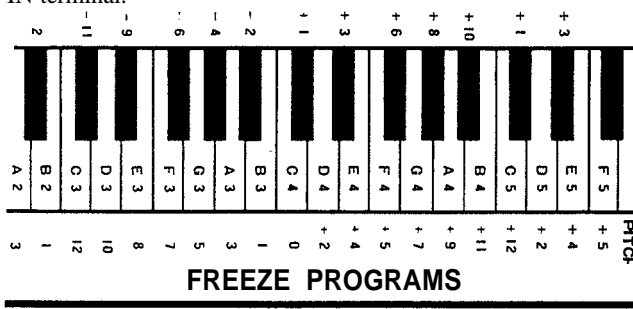

23. FREEZE 1

24. FREEZE 2

40. STEREO FREEZE

The FREEZE programs allow sampling (digital recording) and playback of sounds received at the SPX1000's inputs. The FREEZE 1 and FREEZE 2 programs permit sampling for a maximum of 5.8 seconds, while the STEREO FREEZE program allows sampling for a maximum of 2.9 seconds. The FREEZE 1 and FREEZE 2 programs differ only in the playback functions provided.

PARAMETERS ACCESSED BY THE PARAM KEY

■ **23. FREEZE 1**

The FREEZE 1 program allows single playback of the sampled sound, with adjustable start and end points.

Record Mode (REC. MODE): MANUAL, AUTO

Determines how sampling is to be triggered. If MANUAL is selected, sampling is initiated either by pressing the parameter Δ key, the TRIGGER key, or a footswitch connected to the rear-panel TRIGGER 1 SW jack. If AUTO is selected, sampling is automatically triggered by any input signal of sufficient level.

Trigger Delay (TRG. DLY): -5800 – +1000 milliseconds

This parameter sets a delay between triggering and actual initiation of the sampling process. If a negative value is specified, input signals are temporarily stored and the sound is sampled from the specified time before the trigger occurs.

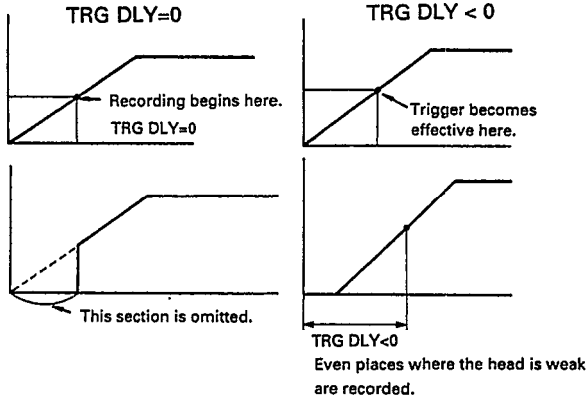

Record Ready (RECORD):

The RECORD display must be called before sampling can begin. With the RECORD display showing, press the parameter key and display will change to RECORD READY. Sampling can now be starting using either the MANUAL or AUTO method described above. The display changes to “- - - - -” while sampling is in progress, and then to “OK” when sampling is complete. Any previous data in the freeze memory is erased when the RECORD function is executed.

The sampled sound can now be played back by pressing the TRIGGER key or a footswitch connected to the rear-panel TRIGGER 1 SW jack. Playback can also be triggered by an input signal of sufficient amplitude if the INPUT TRG parameter is ON OR BY A SIGNAL APPLIED TO THE REAR-PANEL TRIGGER 2 ANALOG JACK IF THE ANALOG TRG PARAMETER IS ON (see PARAMETERS ACCESSED BY THE INT PARAM KEY). Pitched playback of the sampled sound is possible by transmitting MIDI note ON messages to the SPX1000’s MIDI IN connector from a MIDI keyboard or other device (e.g. play a key on the keyboard).

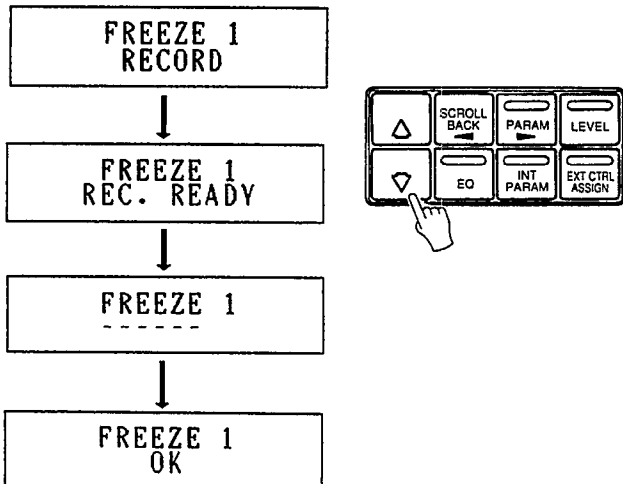

Overdub Ready (OVERDUB):

RECORD (see above) is used to sample a new sound. OVERDUB is used to record a new sound over a previously recorded sound. Call the OVERDUB display and begin overdubbing by using either the MANUAL or AUTO method described above. The display changes to “_____” while overdubbing is in progress, and then to “OK” when overdubbing is complete. OVERDUB can be repeated as many times as necessary.

The initially recorded and overdubbed sound can now be played back by pressing the TRIGGER key or a footswitch connected to the rear-panel TRIGGER 1 SW jack. Playback can also be triggered by an input signal of sufficient amplitude if the INPUT TRG parameter is on or by a signal applied to the rear-panel trigger 2 analog jack if the analog trg parameter is on (see PARAMETERS ACCESSED BY THE INT PARAM KEY). Pitched playback of the sampled sound is possible by transmitting MIDI note ON messages to the SPX1000’s MIDI IN connector from a MIDI keyboard or other device (e.g. play a key on the keyboard).

Playback Start Point (START): 0 – 5800 milliseconds

Total sample time is 5800 milliseconds (5.8 seconds). This parameter determines at what point playback will begin when a trigger occurs.

Playback End Point (END): 0 – 5800 milliseconds

This parameter determines at what point playback will end. If the END point is set to a time earlier than the START point (above), the sampled sound will be played back in reverse.

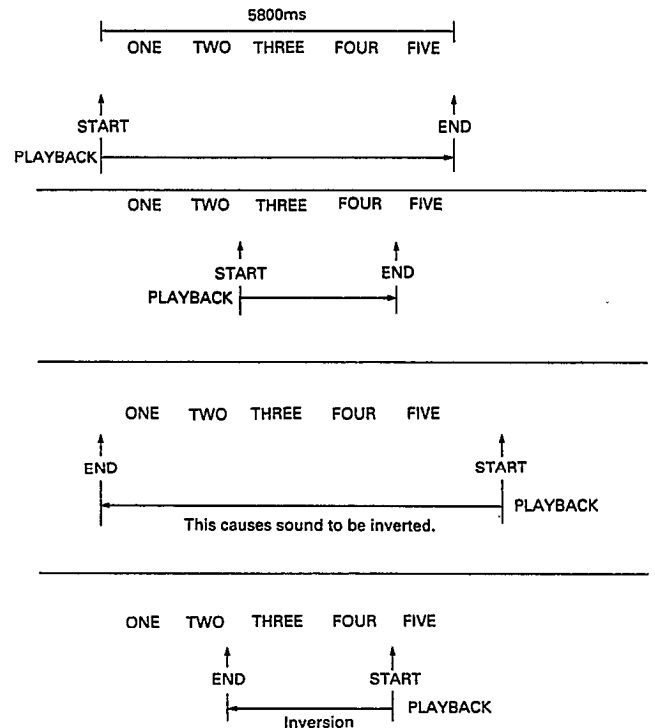

Playback Pitch (PITCH): -24 – +24

Determines the pitch of the playback sound in semitone increments. PITCH can be varied from two octaves below (-24) to two octaves above (+24) the original pitch of the sampled sound.

Playback Pitch Fine Tuning (PITCH FINE): -100 – +100

Permits fine tuning of the playback pitch in one-cent increments (a cent is 1/100th of a semitone).

24. FREEZE 2

The FREEZE 2 program allows looped playback of the sampled sound.

The REC. MODE, TRG. DLY, RECORD, OVERDUB, START, END, PITCH and PITCH FINE parameters of the FREEZE 2 program are exactly the same as those of the FREEZE 1 program. Only the following parameters are different.

Playback Loop Point (LOOP): 0 – 5800 milliseconds

As in the END parameter of FREEZE 1, this parameter sets the end point of the sampled sound, but in the FREEZE 2 program playback is immediately resumed from the START point as soon as the LOOP point is reached. The sampled sound will therefore play continuously as long as the trigger is held ON.

Loop Fine Adjust (LOOP FINE): -200 – +200

This parameter allows fine adjustment of the LOOP end point, making it possible to create the smoothest transition between the LOOP and START points.

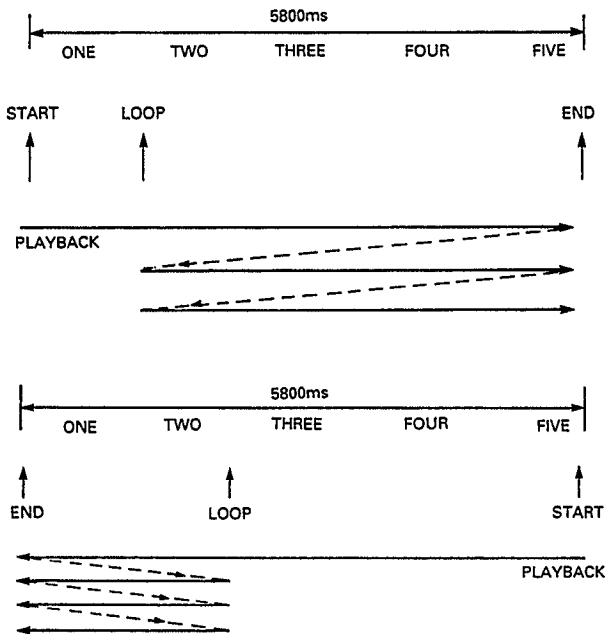

40. STEREO FREEZE

STEREO FREEZE has the same parameters as the FREEZE 1 program, but has shorter TRG. DLY, START and END parameter ranges to allow independent sampling of left and right channel signals.

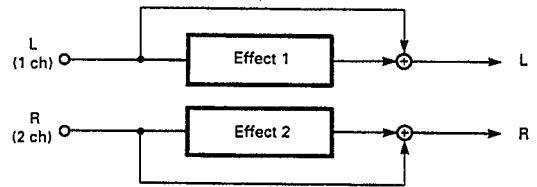

TRG. DLY: -2900 – +1000 milliseconds
START, END: 0 – 2900 milliseconds

PARAMETERS ACCESSED BY THE INT PARAM KEY

Please note that the FREEZE 2 program has only the BASE KEY internal parameter.

Input Trigger (INPUT TRG): OFF, ON

Determines whether playback can be triggered by an input signal of sufficient level.

Analog Trigger (ANALOG TRG): OFF, ON

Determines whether playback can be triggered by an analog signal applied to the rear-panel TRIGGER 2 ANALOG jack.

Trigger Mask (TRG. MSK): 3 – 30000 milliseconds

This parameter makes it impossible to re-trigger playback function until the programmed time has elapsed.

Base Key (BASE KEY): OFF, C1 – C6

This parameter sets the “BASE KEY” for an external MIDI synthesizer used to control pitched playback of the sampled sound (the MIDI OUT terminal of the synthesizer must be connected to the SPX1000 MIDI IN terminal, and the SPX1000 must be set to receive on the MIDI channel on which the synthesizer is transmitting). If, for example, the BASE KEY parameter is set to C4, pressing the C3 key on the synthesizer (C3 is one octave lower than C4) will cause the sampled sound to play one octave lower than its normal pitch. If a key more than two octaves higher or lower than the BASE KEY is pressed, the resultant pitch change setting will still be within the -24 to +24 range, as shown in the illustration below. If the BASE KEY parameter is set OFF, pitch cannot be controlled via the MIDI IN terminal.

PAN PROGRAMS

25. PAN

26. TRIGGERED PAN

There are two Pan Programs:

PARAMETERS ACCESSED BY THE PARAM KEY

■ 25. PAN

This is a very sophisticated pan program that allows creation of “rotary” pan in addition to straightforward pan effects.

Pan Type (TYPE): $L \rightarrow R$, $L \leftarrow R$, $L \leftrightarrow R$, **L-TURN**, **R-TURN**

Determines the direction in which the sound sweeps across the stereo sound field. The L-TURN and R-TURN parameters produce a pan which seems to rotate toward and away from the listener in the specified direction.

Pan Speed (PAN SPEED): 0.05 – 40 Hz

Sets the speed of the PAN effect (i.e. how rapidly the signal sweeps from channel to channel).

Front/Rear Depth (F/R DEPTH): 0 – 100%

When the L-TURN or R-TURN pan type is selected, this parameter sets the apparent depth of the sweep from front to rear.

Left/Right Depth (L/R DEPTH): 0 – 100%

Sets the “depth” of the pan sweep from left to right and right to left.

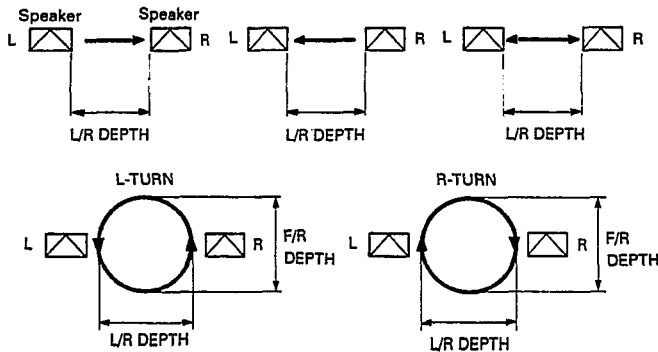

■ 26. TRIGGERED PAN

When triggered, this program automatically pans the sound image between left and right or right and left in the stereo sound field – with programmable attack, pan and release rates.

Trigger Level (TRG. LEVEL): 1 – 100%

Determines the level of the input signal required to trigger the panning effect. At 100% only very high-level input signals will trigger the pan, while at 0% even the tiniest input signal will trigger the pan.

Trigger Delay (TRG. DLY): -100 – +100 milliseconds

Produces a delay between the time at which the effect is triggered and that at which it actually begins. If a minus value is programmed, the input signal is delayed so that, effectively, the effect begins before the signal appears.

Trigger Mask (TRG. MSK): 3 – 24000 milliseconds

This parameter makes it impossible to re-trigger the effect until the programmed time has elapsed.

Attack Time (ATTACK): 3 – 24000 milliseconds

Determines how rapidly the panning effect begins.

Panning Time (PANNING): 3 – 24000 milliseconds

Determines how long it takes to complete the main portion of the pan.

Release Time (RELEASE): 3 – 24000 milliseconds

Determines the speed of the end of the pan.

Pan Direction (DIRECTION): $L \rightarrow R$, $L \leftarrow R$

Determines the direction in which the sound sweeps across the stereo sound field.

Left/Right Channel Balance (L/R BALANCE): 0 – 100%

Determines the maximum extent of the pan sweep. For example, a setting of 100% produce a full pan from the extreme left to right or vice versa, while a setting of 50% a pan that is more restricted in its width across the stereo sound field.

Analog Trigger Level (A. TRG LEVEL): 0 – 100%

When an analog signal applied to the rear-panel TRIGGER 2 ANALOG jack is used to trigger the pan effect, this parameter determines the level of the input signal required to trigger the effect. At 100% only very high-level input signals will trigger the effect, while at 1% even the tiniest input signal will trigger the effect. When this function is used the TRG. LEVEL parameter should be set to the highest value (100%) so that only signals applied to the TRIGGER 2 ANALOG jack will activate the effect.

MIDI Trigger (MIDI TRG.): OFF, ON

When this parameter is turned ON, a KEY ON EVENT message from an external MIDI keyboard can be used to trigger the pan. A KEY ON EVENT message is transmitted whenever a note on a MIDI keyboard is played.

NOTE:

This effect can also be triggered by the front-panel TRIGGER key or a footswitch plugged into the rear-panel TRIGGER 1 SW jack.

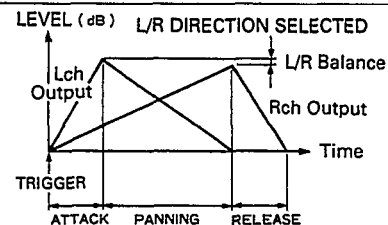

PARAMETERS ACCESSED BY THE INT PARAM KEY

HPF FRQ, LPF FRQ

DISTORTION PROGRAM

■ 27. DISTORTION

The distortion program is capable of producing an extremely broad range of distortion sounds.

PARAMETERS ACCESSED BY THE PARAM KEY

Distortion (DISTORTION): 0 – 100%

This parameter sets the “degree” of distortion produced. A setting of 0 produces a perfectly clean sound, while a setting of 100 produces the most heavily distorted sound.

Midrange EQ Frequency (MID FRQ.): 250 Hz – 5.6 kHz

Sets the mid-frequency range to be boosted or cut using the next parameter: MID GAIN.

Midrange EQ Gain (MID GAIN): -12 – +12 dB

Boosts or cuts response in the frequency range set by the MID FRQ parameter (above). A setting of 0 produces no boost or cut. Minus settings (e.g. -6 dB) cut response in the selected frequency range, while plus settings (e.g. +12 dB) boost response.

Treble Boost/Cut (TREBLE): -12 – +12 dB

Permits boosting or cutting the high-frequency range. Minus settings (e.g. -6 dB) reduce the high-frequency content of the sound, while plus settings (e.g. +6 dB) emphasize the high-frequencies.

Distortion Delay (DELAY): 0.1 – 1000 milliseconds

Sets the delay between the direct sound and the beginning of the distortion effect.

PARAMETERS ACCESSED BY THE INT PARAM KEY

Trigger Level (TRG. LEVEL) : 0 – 100

The level of the input signal which allows the gate to open (or applies a trigger, in other words) can be set. The larger the value, the larger the input signal needed to open the gate. If this is not specified, the gate will not open.

Release Time (RELEASE) : 3ms – 2400ms

This is the time between the point where the gate begins to close and the point where it is fully closed. The larger the value, the smoother the cut-off of the reverberation sound becomes.

MULTI-EFFECT PROGRAMS

■ 28. MULTI (CHO&REV)

■ 29. MULTI (SYM+REV)

■ 30. MULTI (EXC&REV)

The SPX1000 multi-effect programs combine compressor, distortion, equalizer or dynamic filter (access via EQ key), reverb and chorus or exciter effects. Refer to the effect configuration diagram for each program to understand how the various effects are “connected.”

In all cases the first parameter display allows turning each effect ON or OFF. Use the PARAM and SCROLL BACK keys to move the underline cursor to the desired effect, then use the parameter Δ or ∇ key to turn the effect ON or OFF:

MULTI(CHO&REV)
●CO ○DI ●CH ●RV

“○” = OFF. “●” = ON. In this example display COMPRESSOR (CO), CHORUS (CH) and REVERB (RV) are ON, while DISTORTION (DI) is OFF.

Once the desired effects have been selected, use the PARAM key to move on to the main parameters. Only parameters for effects that are turned ON will appear.

PARAMETERS ACCESSED BY THE INT PARAM KEY

All of the multi-effect programs have both COMPRESSOR and DISTORTION: however, all parameters for these are accessed through the INT PARAM key.

Compressor Attack (CO. ATTACK): Refer to COMPRESSOR on page 29.

Compressor Release (CO. RELS): Refer to COMPRESSOR on page 29.

Compressor Threshold (CO. THRSLD): Refer to COMPRESSOR on page 29.

Compressor Ratio (CO. RATIO): Refer to COMPRESSOR on page 29.

Distortion (DI.DIST): Refer to Distortion on page 25.

Distortion Mid Frequency (DI. MID F): Refer to DISTORTION on page 25.

Distortion Mid Gain (DI. MID G): Refer to DISTORTION on page 25.

Distortion Treble (DI. TREBLE): Refer to DISTORTION on page 25.

Trigger Level (TRG. LEVEL) : Refer to COMPRESSOR on page 29.

Release Time (Release) : Refer to COMPRESSOR on page 29.

PARAMETERS ACCESSED BY THE PARAM KEY

■ 28. MULTI (CHO&REV)

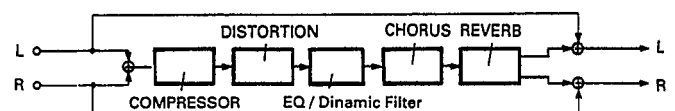

Chorus Frequency (CH. FRG): 0.05 – 40 Hz

Chorus Delay Modulation Depth (DM DEPTH): 0% – 100%

This sets the amount by which the delay time of one delay signal is varied in relation to the other, and thus the depth of the CHORUS effect.

Chorus Amplitude Modulation Depth (AM DEPTH): 0% – 100%

Sets the amount by which the amplitude (level) of the input signal is varied.

Reverb Time (RV. RT): Refer to REV 1 HALL on page 14.

High Frequency Reverb Time Ratio (RV. HIGH): Refer to REV 1 HALL on page 14.

Reverb Initial Delay (RV. DLY): Refer to REV 1 HALL on page 14.

Reverb Mix (RV. MIX): 0 – 100%

Determines the mix between the signal entering the reverb processor and the reverb sound.

■ 29. MULTI (SYM+REV)

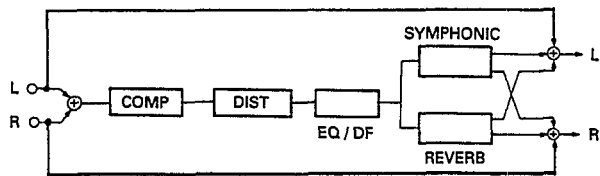

Symphonic Frequency (SY FRQ): Refer to SYMPHONIC on page 18.

Symphonic Depth (SY DEPTH): Refer to SYMPHONIC on page 18.

Reverb Time (RV. RT): Refer to REV 1 HALL on page 14.

High Frequency Reverb Time Ratio (RV. HIGH): Refer to REV 1 HALL on page 14.

Reverb Initial Delay (RV. DLY): Refer to REV 1 HALL on page 14.

Reverb Mix Level (RV MIX): Refer to MULTI (CHO & REV) on page 26.

■ 30. MULTI (EXC&REV)

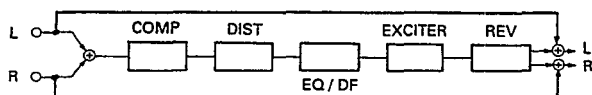

The COMPRESSOR, DISTORTION and REVERB parameters for this program are the same as for MULTI (CHO&REV) and MULTI (SYM+REV), described above. When the EXCITER (EX) effect is turned ON, the following parameters also appear:

EX. HPFF: Refer to EXCITER on page 30.

EX. ENHANCE: Refer to EXCITER on page 30.

EX. MIX LVL: Refer to EXCITER on page 30.

2-CHANNEL PROGRAMS

The 2-channel programs provide different effects for the left (1) and right (2) channels. The input signals to the left (1) and right (2) channels are processed separately. Internal parameters provided for each of the 2-channel programs determine whether the output is mixed and delivered in stereo or each channel functions independently (i.e. mono output x 2).

■ 31. PLATE + HALL

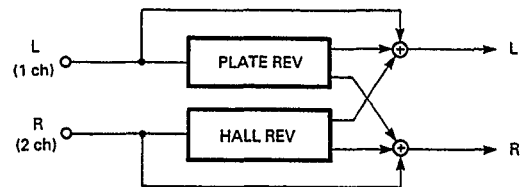

PARAMETERS ACCESSED BY THE PARAM KEY

Plate Reverb Time (PLT RT): Refer to REV 4 PLATE on page 14.

Plate High Frequency Reverb Time Ratio (PLT HIGH): Refer to REV 4 PLATE on page 14.

Plate Diffusion (PLT DIF): Refer to REV 4 PLATE on page 14.

Plate Initial Delay (PLT DLY): Refer to REV 4 PLATE on page 14.

Hall Reverb Time (HAL RT): Refer to REV 1 HALL on page 14.

Hall High Frequency Reverb Time Ratio (HAL HIGH): Refer to REV 1 HALL on page 14.

Hall Diffusion (HAL DIF): Refer to REV 1 HALL on page 14.

Hall Initial Delay (HAL DLY): Refer to REV 1 HALL on page 14.

PARAMETERS ACCESSED BY THE INT PARAM KEY

Stereo or Mono x 2 Output (OUT MODE): ST, MONO x 2

When set to ST (stereo), the output of the left and right-channel processors are mixed and the output signal is delivered in stereo. When MONO x 2 is selected the left and right-channel processors are completely independent.

Plate Low-pass Filter Frequency (PLT LPF): 1 – 16 kHz, THRU

Permits rolling off the high-frequency content of the PLATE signal above the set frequency. The LPF is OFF when set to THRU.

Hall Low-pass Filter Frequency (HAL LPF): 1 – 16 kHz, THRU

Permits rolling off the high-frequency content of the HALL signal above the set frequency. The LPF is OFF when set to THRU.

■ 32. ER + REV

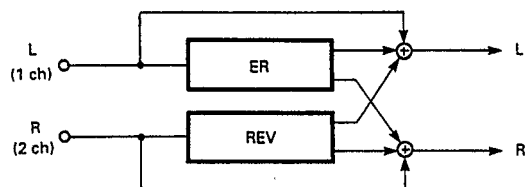

PARAMETERS ACCESSED BY THE PARAM KEY

Early Reflection Type (ER TYPE): Refer to EARLY REF. 1 on page 16.

Early Reflection Room Size (ROOM SIZE): Refer to EARLY REF. 1 on page 16.

Early Reflection Liveness (LIVENESS): Refer to EARLY REF. 1 on page 16.

Early Reflection Diffusion (ER DIF): Refer to EARLY REF. 1 on page 16.

Early Reflection Initial Delay (ER DLY): Refer to EARLY REF. 1 on page 16.

Rev Reverb Time (REV RT): Refer to REV 1 HALL on page 14.

Rev High Frequency Reverb Time Ratio (REV HIGH): Refer to REV 1 HALL on page 14.

Rev Diffusion (REV DIF): Refer to REV 1 HALL on page 14.

Rev Initial Delay (REV DLY): Refer to REV 1 HALL on page 14.

PARAMETERS ACCESSED BY THE INT PARAM KEY

Stereo or Mono x 2 Output (OUT MODE): ST, MONO x 2

When set to ST (stereo), the output of the left and right-channel processors are mixed and the output signal is delivered in stereo. When MONO x 2 is selected the left and right-channel processors are completely independent.

Reverb Low-pass Filter Frequency (REV LPF): 1- 16 kHz, THRU

Permits rolling off the high-frequency content of the REV signal above the set frequency. The LPF is OFF when set to THRU.

■ 33. ECHO + REV

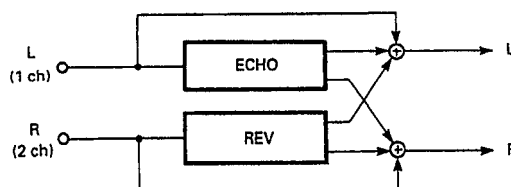

PARAMETERS ACCESSED BY THE PARAM KEY

Echo Left Channel Delay (Lch DLY): Refer to STEREO ECHO on page 17.

Echo Left Channel Feedback (Lch FB): Refer to STEREO ECHO on page 18.

Echo Right Channel Delay (Rch DLY): Refer to STEREO ECHO on page 18.

Echo Right Channel Feedback (Rch FB): Refer to STEREO ECHO on page 18.

Echo High Frequency Feedback (ECHO HIGH): Refer to STEREO ECHO on page 18.

Rev Reverb Time (REV RT): Refer to REV 1 HALL on page 14.

Rev High Frequency Reverb Time Ratio (REV HIGH): Refer to REV 1 HALL on page 14.

Rev Diffusion (REV DIF): Refer to REV 1 HALL on page 14.

Rev Initial Delay (REV DLY): Refer to REV 1 HALL on page 14.

PARAMETERS ACCESSED BY THE INT PARAM KEY

Stereo or Mono x 2 Output (OUT MODE): ST, MONO x 2

When set to ST (stereo), the outputs of the left and right-channel processors are mixed and the output signal is delivered in stereo. When MONO x 2 is selected the left and right-channel processors are completely independent.

Reverb Low-pass Filter Frequency (REV LPF): 1 – 16 kHz, THRU

Permits rolling off the high-frequency content of the REV signal above the set frequency. The LPF is OFF when set to THRU.

■ 34. CHORUS + REV

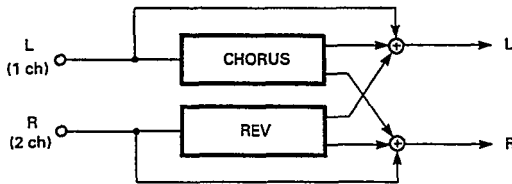

PARAMETERS ACCESSED BY THE PARAM KEY

Chorus Modulation Frequency (MOD FRQ.): Refer to CHORUS on page 18.

Chorus Delay Modulation Depth (DM DEPTH): 0% – 100%

This sets the amount by which the delay time of one delay signal is varied in relation to the other, and thus the depth of the CHORUS effect.

Chorus Amplitude Modulation Depth (AM DEPTH): 0% – 100%

Sets the amount by which the amplitude (level) of the input signal is varied.

Rev Reverb Time (REV TIME): Refer to REV 1 HALL on page 14.

Rev High Frequency Reverb Time Ratio (REV HIGH): Refer to REV 1 HALL on page 14.

Rev Diffusion (REV DIF): Refer to REV 1 HALL on page 14.

Rev Initial Delay (REV DLY): Refer to REV 1 HALL on page 14.

PARAMETERS ACCESSED BY THE INT PARAM KEY

Stereo or Mono x 2 Output (OUT MODE): ST, MONO x 2

When set to ST (stereo), the outputs of the left and right-channel processors are mixed and the output signal is delivered in stereo. When MONO x 2 is selected the left and

right-channel processors are completely independent.

Reverb Low-pass Filter Frequency (REV LPF): 1 – 16 kHz, THRU

Permits rolling off the high-frequency content of the REV signal above the set frequency. The LPF is OFF when set to THRU.

■ 35. PAN + PAN

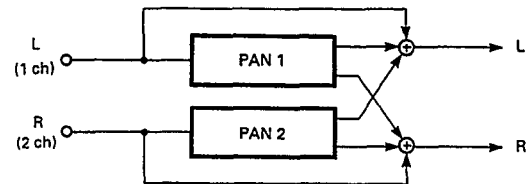

PARAMETERS ACCESSED BY THE PARAM KEY

1 Channel Pan Type (1 PAN TYP): Refer to PAN on page 24.

1 Channel Pan Speed (1 SPEED): Refer to PAN on page 24.

1 Channel Pan Front/Rear Depth (1 F/R DPT): Refer to PAN on page 24.

1 Channel Pan Left/Right Depth (1 L/R DPT): Refer to PAN on page 24.

1 Channel Pan Initial Delay (1 DLY): Refer to PAN on page 24.

2 Channel Pan Type (2 PAN TYP): Refer to PAN on page 24.

2 Channel Pan Speed (2 SPEED): Refer to PAN on page 24.

2 Channel Pan Front/Rear Depth (2 F/R DPT): Refer to PAN on page 24.

2 Channel Pan Left/Right Depth (2 L/R DPT): Refer to PAN on page 24.

2 Channel Pan Initial Delay (2 DLY): Refer to PAN on page 24.

1/2 Channel Pan Phase (PHASE): -180 – +180 degrees

Determines the starting phase of the 2-channel pan (PAN 2) in relation to the left-channel pan (PAN 1).

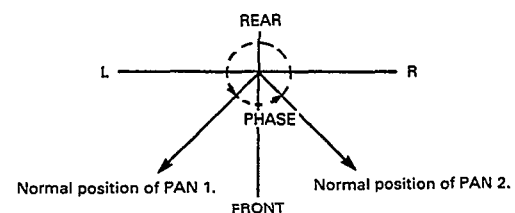

PARAMETERS ACCESSED BY THE INT PARAM KEY

NOT AVAILABLE

COMPRESSOR & EXPANDER PROGRAMS

■ 36. COMPRESSOR

This extremely versatile compressor program allows creation of a wide range of compression and limiting effects. It can simply be used to reduce the dynamic range of a signal, to smooth out the sound of an electric bass or add sustain to an electric guitar. It can help to reduce volume fluctuations as a vocalist moves closer to or away from a microphone, or limit the maximum level of a signal to prevent overloading certain types of amplification of recording equipment. The COMPRESSOR program is a stereo compressor in which the higher signal level + left- or right-channel + is used for gain control.

PARAMETERS ACCESSED BY THE PARAM KEY

Attack Time (ATTACK): 1 – 40 milliseconds

Determines how long it takes for full compression to be reached after the effect is triggered (i.e. the THRESHOLD level is exceeded). The right ATTACK setting is essential to preserve the natural initial attack sound of the instrument used — or modify it as desired.

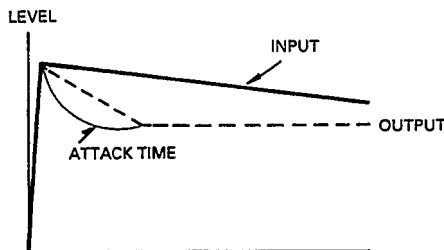

Release Time (RELEASE): 10 – 2,000 milliseconds

Determines how long it takes for compression to be released after the input signal drops below the THRESHOLD level. The RELEASE setting is important to preserve the natural release sound of the instrument used. Too short a RELEASE setting will cause the sound to be cut off unnaturally.

Threshold Level (THRESHOLD): -48 – -6 dB

Determines the level of the input signal at which the compression effect begins. Set at a low level (-48 dB) all input signals will be compressed. At a higher level, only those signals exceeding the THRESHOLD level will be compressed, thus producing a limiting effect. The THRESHOLD level must be set to match the level and characteristics of the instrument being used, as well as the desired effect.

Compression Ratio (RATIO): 1 – 20

This parameter sets the “amount” of compression applied to the input signal. A setting of 1.0 produces no compression, while a setting of 20 produces maximum compression.

Expansion Threshold (EXPAND THRS): -72 – -30 dB

Expansion Ratio (RATIO): 1–5

These parameters can be used to cut out low-level noise.

Expansion is applied to signal levels below the set expander threshold.

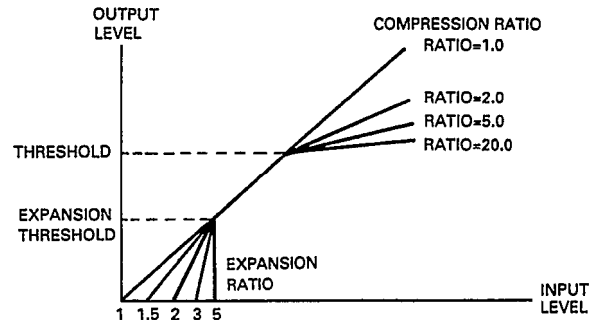

Initial Delay Time (DELAY): 0.1 – 2300 milliseconds

Determines the time delay between the direct sound and the compressed effect sound.

Detect Delay (DET. DLY): -50 – +50 milliseconds

This parameter sets an initial delay between the time the input signal begins (the time the THRESHOLD level is exceeded) and the time the compression effect begins. This delay can be used to allow the initial attack of an instrument to come through completely unaffected while the rest of the signal is compressed. A minus DET DLY setting causes the compressed sound to appear before the direct instrument sound.

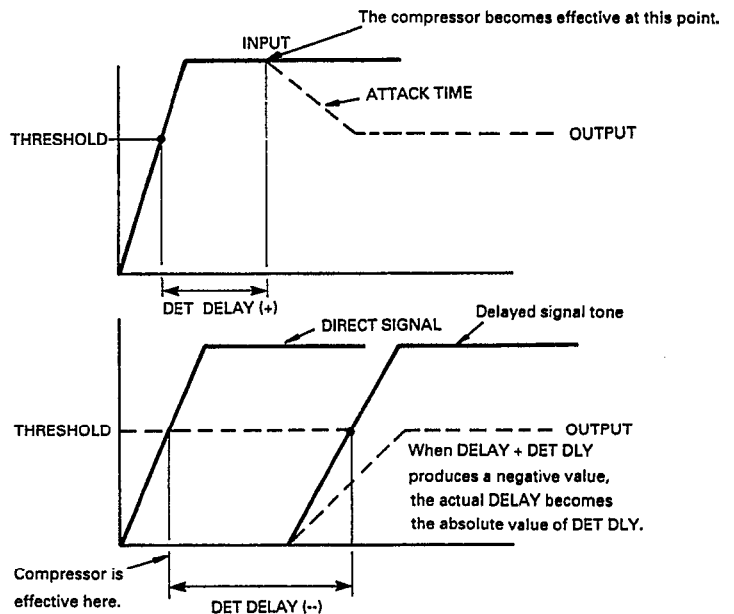

PARAMETERS ACCESSED BY THE INT PARAMETER KEY

Detector High Pass Filter Frequency (DET. HPF): THRU, 500 Hz – 8 kHz

Allows compression to be applied to a specific range of frequencies. Compression is only applied to frequencies higher than the set DET. HPF frequency. Compression is applied to all frequencies when this parameter is set to THRU.

STEREO PROGRAMS

■ 37. LO LVL EXPANDER

The EXPANDER program allows efficient suppression of low-level noise, contributing to a cleaner-sounding overall signal. This is a stereo expander in which the highest signal level – left- or right-channel - is used for gain control.

NOTE:

The EXPANDER program has no internal parameters.

Expansion Threshold (THRESHOLD): -72 – -30 dB

Sets the expansion threshold. Expansion will be applied to all signal levels below the set threshold.

Expansion Ratio (RATIO): 1 – 5

Determines the degree of expansion applied. A setting of 1 produces no expansion, while the maximum setting of 5 produces the greatest degree of expansion (i.e. greatest attenuation of signals below the threshold).

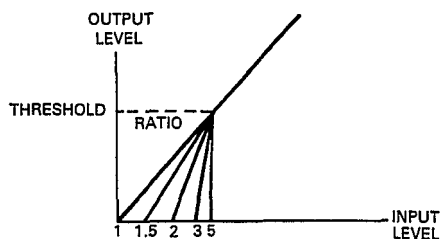

Initial Delay Time (DELAY): 0.1 – 2300 milliseconds

Determines the time delay between the direct sound and the beginning of expander operation.

EXCITER PROGRAM

■ 38. EXCITER

This program artificially adds appropriate harmonics to the input signal, adding luster and effectively bringing “buried” sounds to the foreground.

HPF FRQ: 500Hz – 16kHz

Determines the range of high harmonics added to the input sound. The smaller the value, the greater the range of high harmonics applied.

ENHANCE: 0 – 100%

Sets the level of the harmonics added to the input sound. The higher the value, the greater the exciter effect.

Exciter/Direct Sound Mix (MIX L VL): 0 – 100%

Sets the mixture or balance between the direct input sound and the applied harmonics.

DELAY: 0.1 – 1000.0ms

■ 39. STEREO PITCH

Described under “PITCH CHANGE PROGRAMS” on page 21.

■ 40. STEREO FREEZE

Described under “FREEZE PROGRAMS” on page 23.

5: UTILITY FUNCTIONS

The SPX1000 UTILITY key provides access to a number of important functions. Each press on the UTILITY key advances to the next function until the UTILITY mode is exited:

TITLE EDIT → INPUT MODE → A/D I/O MODE → DIGITAL IN ATT. → USER ER EDIT → MEMORY PROTECT → MIDI CONTROL → MIDI PGM CHANGE → MIDI CTRL ASSIGN → BULK OUT 1 → BULK OUT 2 → F.SW MEMORY RCL → exit UTILITY mode.

It is also possible to scroll forward or backward through the utility functions by using the program select Δ and ∇ keys. The UTILITY mode can be exited at any time by pressing and holding the UTILITY key until its indicator goes out and the UTILITY mode is exited.

TITLE EDIT

This function makes it possible to create original titles for programs you edit and store in memory locations 41 through 99. The TITLE EDIT function is the first one to appear when the UTILITY key is pressed. The "TITLE EDIT" function name appears on the bottom line of the LCD, and an underline cursor appears at the first character position on the top line. The PARAM and SCROLL BACK keys are used to move the cursor back and forth, while the parameter Δ and ∇ keys are used to select a new character for the current cursor position. Simply move the cursor to each character position in turn, selecting the appropriate characters at each position. The available characters are as follows:

#	0	1	2	3	4	5	6	7	8	9	First Space	A	B	C	D	E	F
G	H	I	J	K	L	M	N	O	P	Q	R	S	T	U	V	W	X
Y	Z	a	ä	b	c	d	e	f	g	h	i	j	k	l	m	n	
o	ö	p	q	r	s	t	u	ü	v	w	x	y	z	[]	<	
>	:	.	*	+	-	=	&	/	,	.	%	!	?	←	→		
「	」	"	・	ア	イ	ウ	エ	オ	カ	キ	ク						
ケ	コ	サ	シ	ス	セ	ソ	タ	チ	ツ	ッ	テ	ト	ナ	ニ	ヌ	ネ	ノ
ハ	ヒ	フ	ヘ	ホ	マ	ミ	ム	メ	モ	ヤ	ユ	ヨ	ヨ	ラ	リ		
ル	レ	ロ	ワ	ヲ	ン												

NOTE:

If you attempt to use the TITLE EDIT function while a ROM memory location (1—40) is selected, the "RAM (41—99) ONLY" display will appear on the top line of the LCD and title editing will not be possible.

INPUT MODE

Described under "INPUT MODES" on page 14.

A/D I/O MODE

Described under DIGITAL I/O MODES" on page 15.

DIGITAL IN ATT.

This function makes it possible to vary the input level of the digital input from 0dB to -60dB.

USER ER EDIT

This function makes it possible to create up to four original ER (Early Reflection) patterns — A, B, C and D — that can be selected and used by the EARLY REF. 3 effect program. Each pattern is comprised of up to 19 separate reflections. The delay, level a stereo position (pan) of each reflection can be individually programmed.

1. Use the UTILITY key to call the USER ER EDIT function.
2. Use the parameter Δ and ∇ keys to select the pattern you wish to edit: A, B, C or D.
3. Press the PARAM key to call the "# 1 DLY=" parameter, and use the parameter Δ and ∇ keys to program the delay time for the first early reflection.
4. Press the PARAM key to call the "# 1 LVL=" parameter, and use the parameter Δ and ∇ keys to program the level for the first early reflection.
5. Press the PARAM key to call the "# 1 PAN=" parameter, and use the parameter Δ and ∇ keys to program the pan. (stereo) position from -45 degrees (fully left) to +45 degrees (fully right) for the first early reflection.
6. Press the PARAM key to move on to the DLY, LVL and PAN parameters for the second and subsequent reflections (up to 19) and program each as above. The SCROLL BACK key can be used at any time to scroll backwards through the USER ER EDIT parameters.

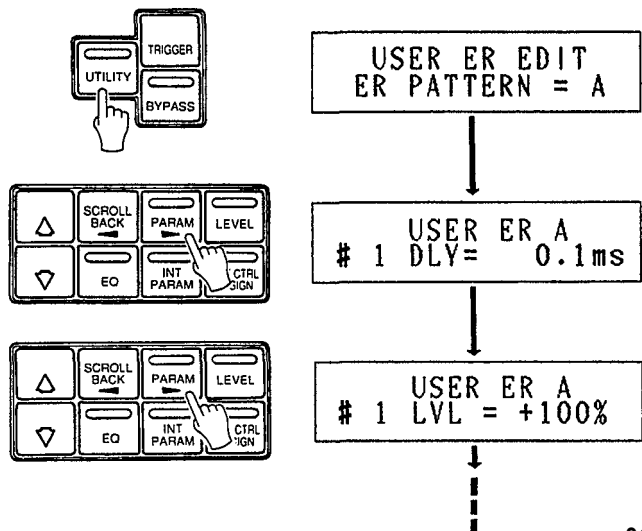

MEMORY PROTECT

The MEMORY PROTECT function must be OFF prior to performing a STORE operation. If you attempt to execute a STORE while MEMORY PROTECT is ON, the "PROTECTED" display will appear and the STORE operation will be aborted.

1. Press the UTILITY key a few times until the MEMORY PROTECT function appears.
2. MEMORY PROTECT can be turned ON by pressing the parameter Δ key and off by pressing the parameter ∇ key.

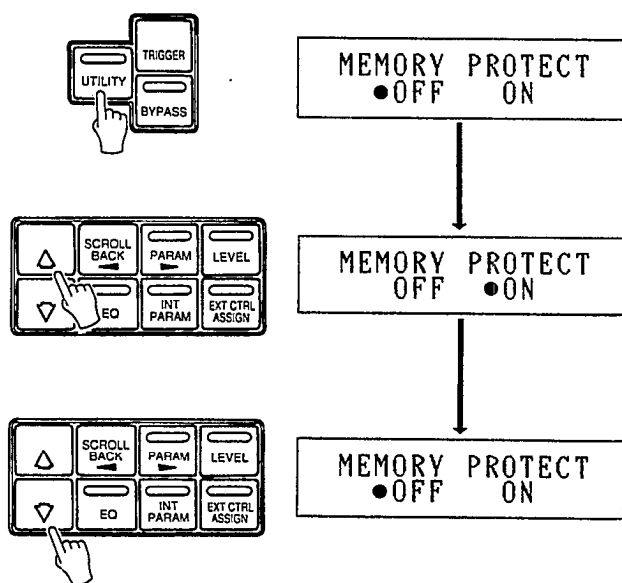

MIDI CONTROL & MIDI PGM CHANGE

The SPX1000 makes it possible to select specific programs via external MIDI control. You can set up the SPX1000 for example, so that when you select a voice on a synthesizer the most appropriate effect for that voice is automatically selected. This is accomplished because each time you select a voice on your MIDI synthesizer it transmits the corresponding MIDI PROGRAM CHANGE NUMBER. The SPX1000 receives this PROGRAM CHANGE NUMBER and selects the effect program that you have assigned to it using the MIDI PROG CHANGE function which will be described below. The SPX1000 also accepts MIDI KEY ON EVENT messages to trigger some of the gate effects, and MIDI KEY ON NUMBERS to set the PITCH parameter of the PITCH CHANGE effects. The SPX1000 actually can be programmed with four completely independent sets of MIDI PROGRAM CHANGE NUMBER/MEMORY NUMBER assignments. Each of these is contained in a different "bank": A, B, C or D. Each BANK may also be programmed to receive on a different MIDI channel. An example of the way the four banks may be programmed with different receive channels and program number/memory number assignments is given below:

Bank Selection and MIDI Channel Programming

1. Press the UTILITY key until the MIDI CONTROL function appears.
2. The underline cursor should be under the BANK parameter. Use the parameter Δ and ∇ keys to select the bank you wish to program.
3. Move the cursor to the "ch=" parameter by pressing the PARAM key, then use the parameter Δ and ∇ keys to set the receive MIDI channel (1 + 16), the OMNI mode (all channels can be received), or turn MIDI reception OFF for the selected bank. The underline cursor can be moved back to the BANK parameter if necessary by pressing the SCROLL BACK key.

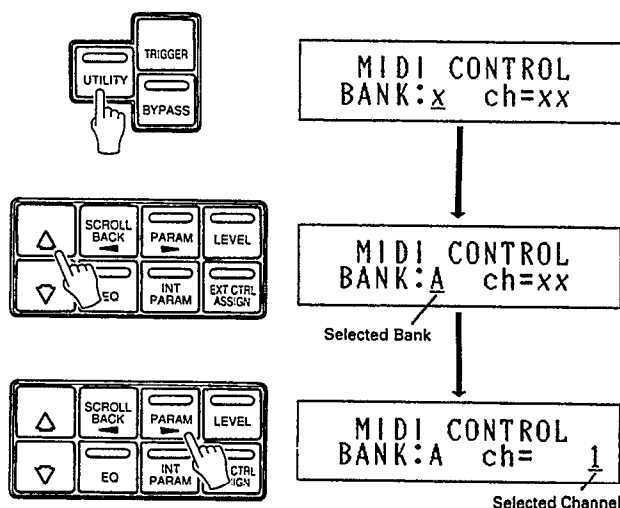

Assigning Effects to MIDI Program Change Numbers

1. Select the MIDI PGM CHANGE function using the UTILITY key or program select Δ and ∇ keys. The underline cursor should be under the PGM parameter.
2. Use the parameter Δ and ∇ keys to select the program change number to which a new SPX1000 memory location is to be assigned. The range of available program change numbers is from 1 to 128.
3. Move the underline cursor to the MEM parameter by pressing the PARAM key. Use the parameter Δ and ∇ keys to select the memory location number containing the effect which is to be assigned to the currently selected program change number.
4. Move the underline cursor back to the PGM parameter and repeat the above steps to assign as many program change numbers as necessary.

NOTE:

The program number/memory number assignments made are stored in the BANK selected in the previous MIDI CONTROL function. To program the program change/memory number assignments for a different BANK, return to the MIDI CONTROL function, select the desired BANK, then program the required assignments.

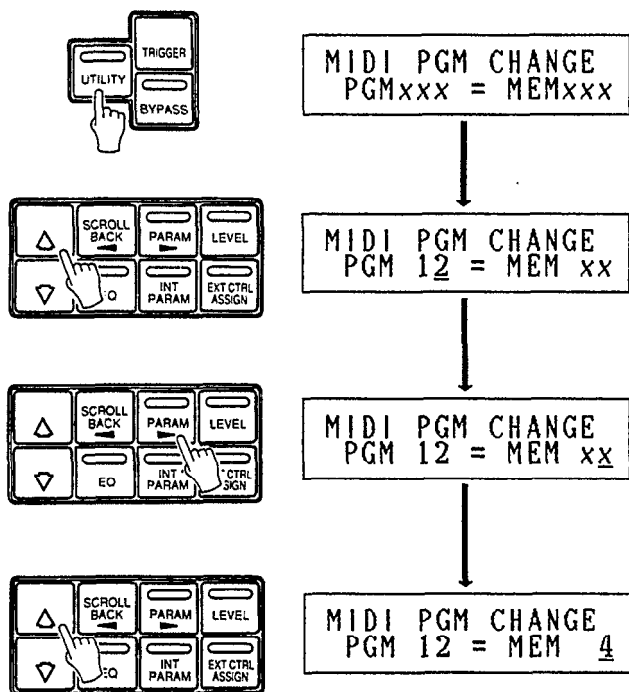

MIDI CTRL ASSIGN

This function makes it possible to use MIDI control change message to control the parameters assigned to the EXT CTRL/ FOOT VOL 1 and 2 controllers (see "EXTERNAL CONTROL ASSIGNMENT" on page 10).

1. Use the UTILITY key to call the MIDI CTRL ASSIGN function.
2. The underline cursor should be under the ASS (Assign) parameter. Use the parameter Δ and ∇ keys to select either ASS 1 for control of the parameter assigned to FVOL1, or ASS2 for control of the parameter assigned to FVOL2.
3. Press the PARAM \blacktriangleright key to move the cursor to the right parameter and select the MIDI control change message you will use to control the assigned parameter by using the program select Δ and ∇ keys.

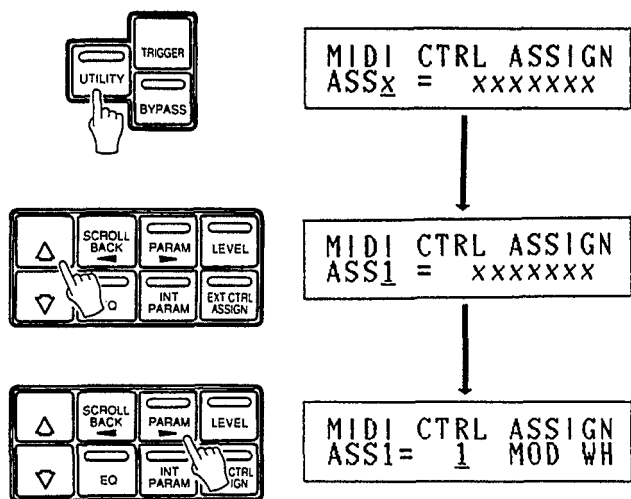

OFF	No control change numbers accepted
0	Control change number 0
1 MOD WH	Modulation Wheel
2 BREATH	Breath Controller
3	Control change number 3
4 FOOT C	Foot Controller
5 PORT T	Portamento Time
6 DATA E	Data Entry
7 VOLUME	Volume
8—63	Control change numbers 8 through 63
64 SUST SW	Sustain Switch
65 PORT SW	Portament Switch
66 SUST P	Sustain Pedal
67 SOFT P	Soft Pedal
68—95	Control change number 68 through 95 (Switch)
96—120	Control change number 96 through 120

If, for example, you select 1 MOD WH, the assigned parameter can be controlled from the modulation wheel of a synthesizer connected to the SPX1000 MIDI IN connector (assuming that the MIDI channels are properly matched). The cursor can be moved back to the ASS parameter if necessary by pressing the SCROLL BACK key.

BULK OUT 1 & BULK OUT 2

This function permits dumping program data and/or BANK MIDI assignments via the MIDI OUT terminal (The MIDI THRU/OUT terminal must be switched to MIDI). This permits transferring data to a second SPX1000 or storing the data on a MIDI data recorder. The SPX1000 automatically reloads data received from a MIDI data recorder into the appropriate memory locations. *

The BULK OUT 1 function permits dumping all SPX1000 memory data (ALL), independent memory locations (MEM), and independent program change assignment banks (BANK). The BULK OUT 2 function permits dumping user early reflection patterns (USER.ER) or all system data (SYSTEM, current system status).

1. Use the UTILITY key to select the BULK OUT 1 or BULK OUT 2 function.
2. Use the PARAM and SCROLL BACK keys to select the data group to be dumped (ALL, MEM, BANK, USER.ER or SYSTEM).
3. If you selected ALL or SYSTEM, simply press the STORE key to execute the bulk dump.
4. If you select MEM, BANK or USER.ER, use the parameter Δ and ∇ keys to select the desired memory location number, bank or user reflection pattern, then press STORE to execute the BULK DUMP operation. Selecting * instead of a number will cause all the memories, all the banks, or all the user reflection patterns to be transmitted.

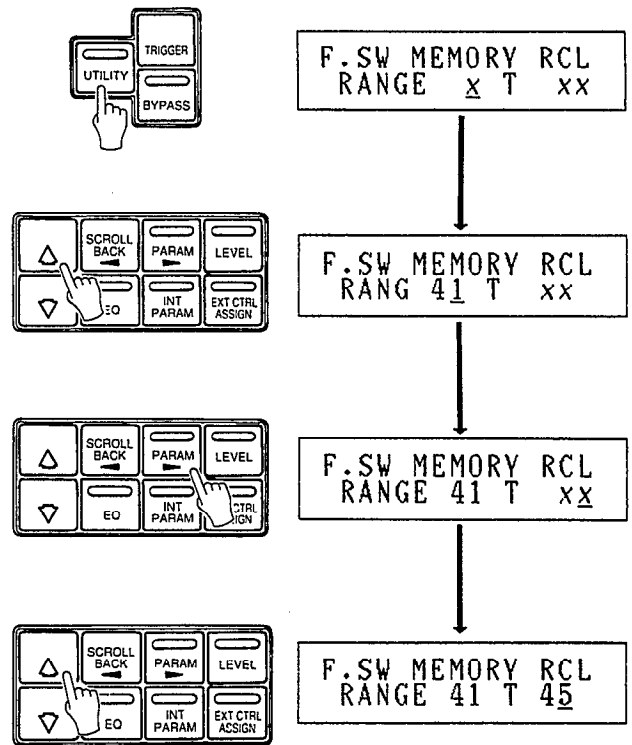
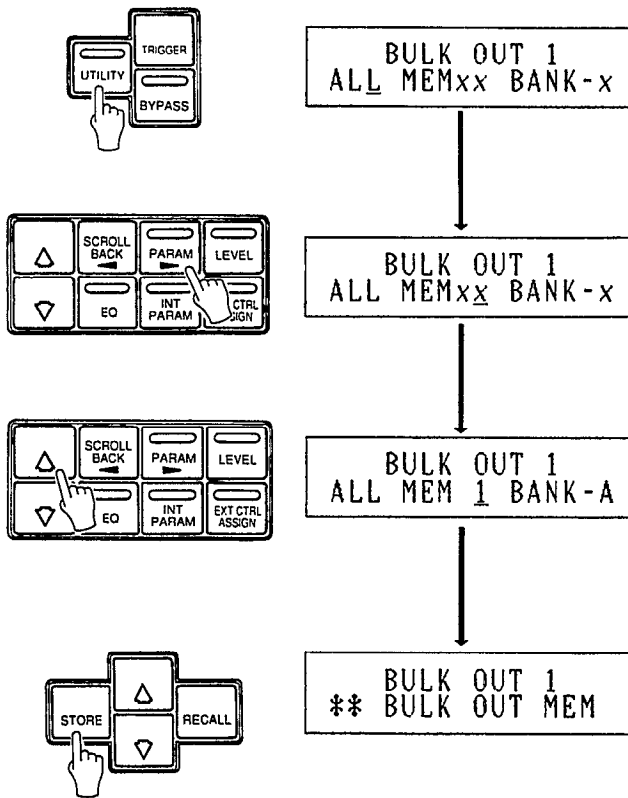

F.S.W. MEMORY RCL RANGE 50 TO 60



If, for example, the RANGE parameter is set to “50 TO 60” as shown in the LCD illustration above, each time the footswitch is pressed the next highest memory location will be selected until the last number in the specified range is reached. After the last number in the specified range, the first (lowest) number is selected and the process repeated.

F.S.W. MEMORY RCL RANGE 44 TO 41

Reverse sequences can be programmed by entering the highest number in the range before the lowest, as shown below.

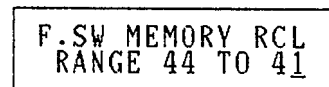

In this case the selection sequence is: 44 → 43 → 42 → 41 → 44, etc.

* A bulk dump will only be received by the SPX1000 if its MEMORY PROTECT function is OFF and the MIDI channel is the same as that of the transmitting equipment. Since bulk data from a second SPX1000, for example, is loaded into the memory location(s) that it was transmitted from, make sure that those locations do not contain important data that will be overwritten.

F.S.W. MEMORY RCL

The SPX1000 permits memory selection via an optional Yamaha FC5 footswitch connected to the “INC/DEC” footswitch jack. The F.S.W. MEMORY RCL function permits setting the range of memory location numbers that will be selected when the footswitch is pressed.

1. Use the UTILITY key to call the F.S.W. MEMORY RCL function. The underline cursor should be located under the first memory number in the range.
2. Use the parameter Δ and ∇ keys to enter the first number in the range.
3. Press the PARAM key to move the cursor to the second number in the range.
4. Use the parameter Δ and ∇ keys to enter the second number in the range.

6: DATA & SPECIFICATIONS

ROM CONTENTS AND CONTROLLABLE PARAMETERS

Memory No.	Program Name	Function Key	Parameter											CTRL No. PARAMETER NAME MIN ~ MAX					
			1	2	3	4	5	6	7	8	9	10	11						
1	REV1 HALL	PARAM	REV TIME	HIGH	DIFFUSION	INI DLY	HPF FRQ.	LPF FRQ.											
				x0.1 ~ x1.0	0 ~ 10	0.1 ~ 1000.0 ms	* 1	* 2											
				x0.6	5	30.0 ms	THRU	8.0 kHz											
			ER/REV BAL	REV DLY	DENSITY	TRG. LEVEL	TRG DLY	HOLD	RELEASE	A TRG. LVL	MIDI TRG.								
			0 ~ 100 %	0.1 ~ 300.0 ms	0 ~ 4	0 ~ 100	-100.0 ~ 100.0ms	1 ~ 24000 ms	3 ~ 24000 ms	0 ~ 100	OFF, ON								
			50 %	0.1 ms	4	0	-7.0 ms	150 ms	5 ms	100	OFF								
2	REV2 ROOM	PARAM	REV TIME	BALANCE															
				0.0 ~ 100.0 %															
			REV TIME	HIGH	DIFFUSION	INI DLY	HPF FRQ.	LPF FRQ.											
			0.1 ~ 480.0 s	x0.1 ~ x1.0	0 ~ 10	0.1 ~ 1000.0 ms	* 1	* 2											
			0.8 s	x0.7	5	20.0 ms	THRU	8.0 kHz											
			ER/REV BAL	REV DLY	DENSITY	TRG. LEVEL	TRG DLY	HOLD	RELEASE	A TRG. LVL	MIDI TRG.								
			0 ~ 100 %	0.1 ~ 300.0 ms	0 ~ 4	0 ~ 100	-100.0 ~ 100.0ms	1 ~ 24000 ms	3 ~ 24000 ms	0 ~ 100	OFF, ON								
			50 %	0.1 ms	4	0	-7.0 ms	150 ms	5 ms	100	OFF								
3	REV3 VOCAL	PARAM	REV TIME	BALANCE															
				0.0 ~ 100.0 %															
			REV TIME	HIGH	DIFFUSION	INI DLY	HPF FRQ.	LPF FRQ.											
			0.3 ~ 480.0 s	x0.1 ~ x1.0	0 ~ 10	0.1 ~ 1000.0 ms	* 1	* 2											
			2.4 s	x0.5	5	45.0 ms	80 Hz	8.0 kHz											
			ER/REV BAL	REV DLY	DENSITY	TRG. LEVEL	TRG DLY	HOLD	RELEASE	A TRG. LVL	MIDI TRG.								
			0 ~ 100 %	0.1 ~ 300.0 ms	0 ~ 4	0 ~ 100	-100.0 ~ 100.0ms	1 ~ 24000 ms	3 ~ 24000 ms	0 ~ 100	OFF, ON								
			50 %	0.1 ms	4	0	-7.0 ms	150 ms	5 ms	100	OFF								
4	REV4 PLATE	PARAM	REV TIME	BALANCE															
				0.0 ~ 100.0 %															
			REV TIME	HIGH	DIFFUSION	INI DLY	HPF FRQ.	LPF FRQ.											
			0.1 ~ 480.0 s	x0.1 ~ x1.0	0 ~ 10	0.1 ~ 1000.0 ms	* 1	* 2											
			1.8 s	x0.7	5	10.0 ms	40 Hz	10 kHz											
			ER/REV BAL	REV DLY	DENSITY	TRG. LEVEL	TRG DLY	HOLD	RELEASE	A TRG. LVL	MIDI TRG.								
			0 ~ 100 %	0.1 ~ 300.0 ms	0 ~ 4	0 ~ 100	-100.0 ~ 100.0ms	1 ~ 24000 ms	3 ~ 24000 ms	0 ~ 100	OFF, ON								
			50 %	0.1 ms	4	0	-7.0 ms	150 ms	5 ms	100	OFF								

* 1: THRU, 32 Hz ~ 1.0 kHz
* 2: 1.0 ~ 16 kHz, THRU

MONO IN [L/R MIX] - SINGLE

Memory No.	Program Name	Function Key	Parameter												
			1	2	3	4	5	6	7	8	9	10	11		
5	REV5 ECHO ROOM	<input type="checkbox"/> PARAM <input type="checkbox"/> INT PARAM <input type="checkbox"/> EXT CTRL ASSIGN	REV TIME	WIDTH	HEIGHT	DEPTH	WALL VARY	US. POSI.	HIGH	DIFFUSION	IDI DLY	HPF FRQ.	LPF FRQ.		
			0.3 ~ 480.0 s	0.5 ~ 100.0 m	0.5 ~ 100.0 m	0.5 ~ 100.0 m	0 ~ 30	* 1	0.1 ~ 1.0	0 ~ 10	0.1 ~ 1000.0 ms	* 2	THRU	* 3	
			1.5 s	19.4 m	8.3 m	13.7 m	7	FRONT	0.7	5	25.0 ms			8.0 kHz	
			12	13	14	15	16	17	18						
			WIDTH FINE	HEIGHT FINE	DEPTH FINE	W. VARY FINE	W DECAY	H DECAY	D DECAY						
			-100 ~ 100	-100 ~ 100	-100 ~ 100	-100 ~ 100	RT x 0.1 ~ 10.0	RT x 0.1 ~ 10.0	RT x 0.1 ~ 10.0						
			0	0	0	0	1.0	1.0	1.0						
			ER/REV BAL	REV DLY	DENSITY	TRG. LEVEL	TRG DLY	HOLD	RELEASE	A TRG. LVL	MIDI TRG.				
			0 ~ 100 %	0.1 ~ 300.0 ms	0 ~ 4	0 ~ 100	-100.0 ~ 100.0 ms	1 ~ 24000 ms	3 ~ 24000 ms	0 ~ 100	OFF, ON				
			50 %	50.0 ms	4	0	-7.0 ms	150 ms	5 ms	100	OFF				
			1	2											
REV TIME	BALANCE														
0.0 ~ 100.0 %	0.0 ~ 100.0 %														
6	EARLY REF. 1	<input type="checkbox"/> PARAM <input type="checkbox"/> INT PARAM <input type="checkbox"/> EXT CTRL ASSIGN	EQ TYPE = 1	BALANCE TYPE = 1											
			TYPE	ROOM SIZE	LIVENESS	DIFFUSION	INI DLY	HPF FRQ.	LPF FRG.						
			* 4	0.1 ~ 25.0	0 ~ 10	0 ~ 10	0.1 ~ 1000.0 ms	* 2	* 3						
			S - HALL	2.0	5	5	10.0 ms	THRU	10 kHz						
			ER NUMBER	FB DLY	FB GAIN	FB HIGH									
			1 ~ 19	0.1 ~ 2600.0 ms	-99 ~ 99 %	0.1 ~ 1.0									
			19	150.0 ms	0 %	0.7									
			1	2											
			REV TIME	BALANCE											
			0.0 ~ 100.0 %	0.0 ~ 100.0 %											
			7	EARLY REF. 2	<input type="checkbox"/> PARAM <input type="checkbox"/> INT PARAM <input type="checkbox"/> EXT CTRL ASSIGN	EQ TYPE = 1	BALANCE TYPE = 1								
TYPE	ROOM SIZE	LIVENESS				DIFFUSION	INI DLY	HPF FRQ.	LPF FRG.						
* 4	0.1 ~ 25.0	0 ~ 10				0 ~ 10	0.1 ~ 1000.0 ms	* 2	* 3						
S - HALL	2.0	5				5	10.0 ms	THRU	10 kHz						
ER NUMBER	FB DLY	FB GAIN				FB HIGH	DENSITY								
1 ~ 19	0.1 ~ 2600.0 ms	-99 ~ 99 %				0.1 ~ 1.0	1 ~ 3								
19	150.0 ms	0 %				0.7	3								
1	2														
REV TIME	BALANCE														
0.0 ~ 100.0 %	0.0 ~ 100.0 %														
8	EARLY REF. 3	<input type="checkbox"/> PARAM <input type="checkbox"/> INT PARAM <input type="checkbox"/> EXT CTRL ASSIGN				EQ TYPE = 1	BALANCE TYPE = 1								
			TYPE	ROOM SIZE	LIVENESS	DIFFUSION	INI DLY	HPF FRQ.	LPF FRG.						
			* 5	0.1 ~ 25.0	0 ~ 10	0 ~ 10	0.1 ~ 1000.0 ms	* 2	* 3						
			USER - A	1.0	5	0	10.0 ms	THRU	10 kHz						
			ER NUMBER	FB DLY	FB GAIN	FB HIGH	DENSITY								
			1 ~ 19	0.1 ~ 2600.0 ms	-99 ~ 99 %	0.1 ~ 1.0	0 ~ 3								
			19	150.0 ms	0 %	0.7	0								
			1	2											
			REV TIME	BALANCE											
			0.0 ~ 100.0 %	0.0 ~ 100.0 %											

* 1: FRONT, CENT., REAR
 * 2: THRU, 32 Hz ~ 1.0 kHz
 * 3: 1.0 ~ 16 kHz, THRU

* 4: S - HALL, L - HALL, RANDOM, REVERSE, PLATE, SPRING
 * 5: USER - A, USER - B, USER - C, USER - D

MONO IN [L/R MIX] - SINGLE

Memory No.	Program Name	Function Key	Parameter											
			1	2	3	4	5	6	7	8	9	10	11	
9	GATE REVERB	PARAM	TYPE	ROOM SIZE	LIVENESS	DIFFUSION	INI DLY	HPF FRQ.	LPF FRG.					
			TYPE A, B	0.1 ~ 25.0	0 ~ 10	0 ~ 10	0.1 ~ 1000.0 ms	* 1	* 2					
			TYPE - A	2.0	5	5	10.0 ms	THRU	10 kHz					
			ER NUMBER	FB DLY	FB GAIN	FB HIGH	DENSITY							
			1 ~ 19	0.1 ~ 2600.0 ms	-99 ~ 99 %	0.1 ~ 1.0	0 ~ 3							
			19	150.0 ms	0 %	0.7	2							
			1	2	EQ TYPE = 1 BALANCE TYPE = 1									
			TYPE	BALANCE										
			0.0 ~ 100.0 %	0.0 ~ 100.0 %										
			TYPE	ROOM SIZE	LIVENESS	DIFFUSION	INI DLY	HPF FRQ.	LPF FRG.					
TYPE A, B	0.1 ~ 25.0	0 ~ 10	0 ~ 10	0.1 ~ 1000.0 ms	* 1	* 2								
TYPE - A	2.0	5	5	10.0 ms	THRU	10 kHz								
ER NUMBER	FB DLY	FB GAIN	FB HIGH	DENSITY										
1 ~ 19	0.1 ~ 2600.0 ms	-99 ~ 99 %	0.1 ~ 1.0	0 ~ 3										
19	150.0 ms	0 %	0.7	2										
10	REVERSE GATE	PARAM	TYPE	ROOM SIZE	LIVENESS	DIFFUSION	INI DLY	HPF FRQ.	LPF FRG.					
			TYPE A, B	0.1 ~ 25.0	0 ~ 10	0 ~ 10	0.1 ~ 1000.0 ms	* 1	* 2					
			TYPE - A	2.0	5	5	10.0 ms	THRU	10 kHz					
			ER NUMBER	FB DLY	FB GAIN	FB HIGH	DENSITY							
			1 ~ 19	0.1 ~ 2600.0 ms	-99 ~ 99 %	0.1 ~ 1.0	0 ~ 3							
			19	150.0 ms	0 %	0.7	2							
			1	2	EQ TYPE = 1 BALANCE TYPE = 1									
			TYPE	BALANCE										
			0.0 ~ 100.0 %	0.0 ~ 100.0 %										
			TYPE	ROOM SIZE	LIVENESS	DIFFUSION	INI DLY	HPF FRQ.	LPF FRG.					
TYPE A, B	0.1 ~ 25.0	0 ~ 10	0 ~ 10	0.1 ~ 1000.0 ms	* 1	* 2								
TYPE - A	2.0	5	5	10.0 ms	THRU	10 kHz								
ER NUMBER	FB DLY	FB GAIN	FB HIGH	DENSITY										
1 ~ 19	0.1 ~ 2600.0 ms	-99 ~ 99 %	0.1 ~ 1.0	0 ~ 3										
19	150.0 ms	0 %	0.7	2										
11	DELAY L, C, R	PARAM	TYPE	BALANCE										
			0.0 ~ 100.0 %	0.0 ~ 100.0 %										
			Lch DLY	Rch DLY	Cch DLY	Cch LVL								
			0.1 ~ 5200.0 ms	0.1 ~ 5200.0 ms	0.1 ~ 5200.0 ms	-200 ~ 200 %								
			100.0 ms	200.0 ms	0.1 ms	0 %								
			FB1 DLY	FB1 GAIN	FB2 DLY	FB2 GAIN	HIGH	HRF FRQ.	LPF FRG.					
			0.1 ~ 5200.0 ms	-99 ~ 99 %	0.1 ~ 5200.0 ms	-99 ~ 99 %	x 0.1 ~ x 1.0	* 1	* 2					
			100.0 ms	0 %	200.0 ms	0 %	1.0	THRU	THRU					
			1	2	EQ TYPE = 1 BALANCE TYPE = 1									
			Lch DLY	BALANCE										
0.0 ~ 100.0 %	0.0 ~ 100.0 %													
LFB DLY	Lch F.B.	RFB DLY	Rch F.B.	HIGH										
0.1 ~ 2600.0 ms	-99 ~ +99 %	0.1 ~ 2600.0 ms	-99 ~ +99 %	x 0.1 ~ x 1.0										
170.0 ms	+60 %	178.0 ms	+58 %	0.9										
LINI DLY	RINI DLY	HRF FRQ.	LPF FRG.											
0.1 ~ 2600.0 ms	0.1 ~ 2600.0 ms	* 1	* 2											
0.1 ms	0.1 ms	THRU	THRU											
1	2	EQ TYPE = 1 BALANCE TYPE = 1												
Lch DLY	BALANCE													
0.0 ~ 100.0 %	0.0 ~ 100.0 %													
12	STEREO ECHO	PARAM	TYPE	BALANCE										
			0.0 ~ 100.0 %	0.0 ~ 100.0 %										
			Lch DLY	Rch DLY	Cch DLY	Cch LVL								
			0.1 ~ 5200.0 ms	0.1 ~ 5200.0 ms	0.1 ~ 5200.0 ms	-200 ~ 200 %								
			100.0 ms	200.0 ms	0.1 ms	0 %								
			FB1 DLY	FB1 GAIN	FB2 DLY	FB2 GAIN	HIGH	HRF FRQ.	LPF FRG.					
			0.1 ~ 5200.0 ms	-99 ~ 99 %	0.1 ~ 5200.0 ms	-99 ~ 99 %	x 0.1 ~ x 1.0	* 1	* 2					
			100.0 ms	0 %	200.0 ms	0 %	1.0	THRU	THRU					
			1	2	EQ TYPE = 1 BALANCE TYPE = 1									
			Lch DLY	BALANCE										
0.0 ~ 100.0 %	0.0 ~ 100.0 %													
LFB DLY	Lch F.B.	RFB DLY	Rch F.B.	HIGH										
0.1 ~ 2600.0 ms	-99 ~ +99 %	0.1 ~ 2600.0 ms	-99 ~ +99 %	x 0.1 ~ x 1.0										
170.0 ms	+60 %	178.0 ms	+58 %	0.9										
LINI DLY	RINI DLY	HRF FRQ.	LPF FRG.											
0.1 ~ 2600.0 ms	0.1 ~ 2600.0 ms	* 1	* 2											
0.1 ms	0.1 ms	THRU	THRU											
1	2	EQ TYPE = 1 BALANCE TYPE = 1												
Lch DLY	BALANCE													
0.0 ~ 100.0 %	0.0 ~ 100.0 %													

* 1: THRU, 32 Hz ~ 1.0 kHz

* 2: 1.0 ~ 16 kHz, THRU

MONO IN [L/R MIX] - SINGLE

Memory No.	Program Name	Function Key	Parameter																				
			1	2	3	4	5	6	7	8	9	10	11										
13	STEREO FLANGE A	PARAM	MOD. FRQ.	MOD. DEPTH	MOD. DLY	F.B. GAIN																	
			0.05 ~ 40.0 Hz	0 ~ 100 %	0.1 ~ 100.0 ms	0 ~ 99 %																	
		INT PARAM	HPF FRQ.	LPF FRQ.																			
			0.7 Hz	70 %																			
		EXT CTRL ASSGN	*1	*2																			
			THRU	THRU																			
					EQ TYPE = 1	BALANCE TYPE = 1																	
		14	STEREO FLANGE B	PARAM	MOD. FRQ.	MOD. DEPTH 1	MOD. DLY 1	MOD. DEPTH 2	MOD. DLY 2	PHASE	FB GAIN												
					0.05 ~ 40.0 Hz	0 ~ 100 %	0 ~ 100.0 ms	0 ~ 100 %	0.1 ~ 100.0 ms	-180.0 ~ +180.0 deg	0 ~ 99 %												
				INT PARAM	1.25 Hz	70 %	1.2 ms	70 %	0.4 ms	+90.0 deg	60 %												
HPF FRQ.	LPF FRQ.																						
EXT CTRL ASSGN	*1			*2																			
	THRU			THRU																			
				EQ TYPE = 1	BALANCE TYPE = 1																		
15	CHORUS			PARAM	MOD. FRQ.	DM. DEPTH	AM. DEPTH																
					0.05 ~ 40.0 Hz	0 ~ 100 %	0 ~ 100 %																
				INT PARAM	0.20 Hz	50 %	40 %																
		HPF FRQ.	LPF FRQ.																				
		EXT CTRL ASSGN	*1	*2																			
			THRU	THRU																			
					EQ TYPE = 1	BALANCE TYPE = 1																	
		16	STEREO PHASING	PARAM	MOD. FRQ.	MOD. DEPTH	MOD. DLY																
					0.05 ~ 40.0 Hz	0 ~ 100 %	0.1 ~ 5.0 ms																
				INT PARAM	1.10 Hz	100 %	3.0 ms																
HPF FRQ.	LPF FRQ.																						
EXT CTRL ASSGN	*1			*2																			
	THRU			THRU																			
				EQ TYPE = 1	BALANCE TYPE = 1																		

* 1: THRU, 32 Hz ~ 1.0 kHz
 * 2: 1.0 ~ 16 kHz, THRU

MONO IN [L/R MIX] - SINGLE

Memory No.	Program Name	Function Key	Parameter																					
			1	2	3	4	5	6	7	8	9	10	11											
17	TREMOLO	PARAM	MOD. FRQ.	MOD. DEPTH																				
			0.05 ~ 40.0 Hz	0 ~ 100 %																				
		MT PARAM	6.00 Hz	50 %																				
			HPF FRQ.	LPF FRQ.																				
		EXT CTRL ASSGN	*1	*2																				
			THRU	THRU																				
					EQ TYPE = 1																			
					BALANCE TYPE = 1																			
		18	SYMPHONIC	PARAM	MOD. FRQ.	MOD. DEPTH																		
					0.05 ~ 40.0 Hz	0 ~ 100 %																		
MT PARAM	0.70 Hz			50 %																				
	HPF FRQ.			LPF FRQ.																				
EXT CTRL ASSGN	*1			*2																				
	THRU			THRU																				
				EQ TYPE = 1																				
				BALANCE TYPE = 1																				
19	ADR-NOISE GATE			PARAM	TRG. LEVEL	TRG. DLY	TRG. MSK	ATTACK	DECAY	DECAY LVL	HOLD	RELEASE	A TRG. LVL	MIDI TRG.										
					0 ~ 100	-100.0 ~ 100.0 ms	3 ~ 24000 ms	3 ~ 24000 ms	0 ~ 100 %	1 ~ 24000 ms	3 ~ 24000 ms	0 ~ 100 %	3 ~ 24000 ms	0 ~ 100	OFF, ON									
		MT PARAM	65	-7.0 ms	5 ms	5 ms	5 ms	5 ms	100 %	90 ms	5 ms	100	OFF											
			HPF FRQ.	LPF FRQ.																				
		EXT CTRL ASSGN	*1	*2																				
			THRU	THRU																				
					EQ TYPE = 1																			
					BALANCE TYPE = 1																			
		20	PITCH CHANGE-1	PARAM	TRG. LEVEL	TRG. DLY	TRG. MSK	ATTACK	DECAY	DECAY LVL	HOLD	RELEASE	A TRG. LVL	MIDI TRG.										
					0.0 ~ 100.0 %	0.1 ~ 23000.0 ms	3 ~ 24000 ms	3 ~ 24000 ms	0 ~ 100 %	1 ~ 24000 ms	3 ~ 24000 ms	0 ~ 100 %	1 ~ 24000 ms	0 ~ 100	OFF, ON									
MT PARAM	0			0.1 ms	0.1 ms	0	0	0	100 %	0	-8	20.0 ms	0 %											
	BASE KEY			1 F. B.	1 LEVEL	2 PITCH	2 FINE	2 DLY	2 F. B.	2 LEVEL														
EXT CTRL ASSGN	OFF C1 ~ C6			+8	+100 %	-24 ~ 24	-100 ~ 100	0.1 ~ 23000.0 ms	-99 ~ +99 %	-24 ~ 24	-100 ~ 100	0.1 ~ 23000.0 ms	-99 ~ 99 %											
	C3			0	+100 %	0	-8	20.0 ms	0	0	-8	20.0 ms	0 %											
				EQ TYPE = 1																				
				BALANCE TYPE = 1																				

*1: THRU, 32 Hz ~ 1.0 kHz
 *2: 1.0 ~ 16 kHz, THRU

MONO IN [L/R MIX] - SINGLE

Memory No.	Program Name	Function Key	Parameter											
			1	2	3	4	5	6	7	8	9	10	11	
21	PITCH CHANGE 2	[PARAM]	L.PITCH	L.FINE	L.DLY	L.F.B.	R.PITCH	R.FINE	R.DLY	R.F.B.				
			-24 ~ 24	-100 ~ +100	0.1 ~ 2300.0 ms	-99 ~ +99 %	-24 ~ +24	-100 ~ +100	0.1 ~ 2300.0 ms	-99 ~ +99 %				
			0	8	0.1 ms	0 %	0	-8	0.1 ms	0 %				
			BASE KEY											
			OFF, C 1 ~ C 6											
			C 3											
				BALANCE										
				0.0 ~ 100.0 %										
				EQ TYPE = 1										
				BALANCE TYPE = 1										
22	PITCH CHANGE 3	[PARAM]	1 PITCH	1 FINE	1 DLY	1 LEVEL	2 PITCH	2 FINE	2 DLY	2 LEVEL	3 PITCH	3 FINE	3 DLY	
			-24 ~ +24	-100 ~ +100	0.1 ~ 4600.0 ms	0 ~ +100 %	-24 ~ +24	-100 ~ +100	0.1 ~ 4600.0 ms	0 ~ +100 %	-24 ~ +24	-100 ~ +100	0.1 ~ 4600.0 ms	
			0	0	0.1 ms	100 %	+4	0	0.1 ms	100 %	+7	0	0.1 ms	
			12											
			3 LEVEL											
			0 ~ +100 %											
			+100 %											
			BASE KEY											
			OFF, C 1 ~ C 6											
			C 3											
23	FREEZE 1	[PARAM]	1 PITCH	BALANCE										
			0.0 ~ 100.0 %	0.0 ~ 100.0 %										
			REC. MODE	TRG. DLY	RECORD	OVER DUB	START	END	PITCH	PITCH FINE				
			MANUAL AUTO	-5800 ~ +1000 ms			0 ~ 5800 ms	0 ~ 5800 ms	-24 ~ +24	-100 ~ +100				
			AUTO	-50 ms			0 ms	5800 ms	0	0				
			INPUT TRG	ANALOG TRG	TRG. MSK	BASE KEY								
			OFF, ON	OFF, ON	8 ~ 3000 ms	OFF, C 1 ~ C 6								
			OFF	OFF	93 ms	C 3								
				EQ TYPE = 1										
				BALANCE TYPE = 1										
24	FREEZE 2	[PARAM]	1 PITCH	BALANCE										
			0.0 ~ 100.0 %	0.0 ~ 100.0 %										
			REC. MODE	TRG. DLY	RECORD	OVER DUB	START	LOOP	LOOP FINE	END	PITCH FINE			
			MANUAL AUTO	-5800 ~ +1000 ms			0 ~ 5800 ms	0 ~ 5800 ms	-200 ~ +200	0 ~ 5800 ms	-100 ~ +100			
			AUTO	-50 ms			0 ms	4000 ms	0	5800 ms	0			
			BASE KEY											
			OFF, C 1 ~ C 6											
			C 3											
				EQ TYPE = 1										
				BALANCE TYPE = 1										

MONO IN [L/R MIX] - SINGLE

Memory No.	Program Name	Function Key	Parameter																				
			1	2	3	4	5	6	7	8	9	10	11										
25	PAN	PARAM	PAN TYPE	SPEED	FIR DEPTH	L/R DEPTH																	
			*1	0.05 ~ 40.00 Hz	0 ~ 100 %	0 ~ 100 %																	
			L-TURN	0.50 Hz	80 %	80 %																	
			HPF FRQ.	LPF FRQ.																			
			*2	*3																			
			THRU	THRU																			
			EQ TYPE = 1	BALANCE																			
			BALANCE	0.0 ~ 100.0 %																			
			TRG. LEVEL	TRG. DLY	TRG. MSK	ATTACK	PANNING	RELEASE	DIRECTION	L/R BALANCE	A TRG. LVL	MIDI TRG.											
			1 ~ 100	-100.0 ~ 100.0ms	3 ~ 24000 ms	3 ~ 24000 ms	3 ~ 24000 ms	3 ~ 24000 ms	L → R, L ← R	0 ~ 100 %	0 ~ 100	OFF, ON											
65	-10.0 ms	1000 ms	23 ms	500 ms	850 ms	L → R	30	100	OFF														
HPF FRQ.	LPF FRQ.																						
*1	*2																						
THRU	THRU																						
EQ TYPE = 1	BALANCE																						
BALANCE	0.0 ~ 100.0 %																						
DISTORTION	MID FRQ.	MID GAIN	TREBLE	DELAY																			
0 ~ 100 %	250Hz ~ 5.6kHz	-12 ~ 12 dB	-12 ~ 12 dB	0.1 ~ 1000.0 ms																			
100 %	280 Hz	+4 dB	+2 dB	0.1 ms																			
TRG. LEVEL	RELEASE																						
0 ~ 100	3 ~ 24000 ms																						
10	108 ms																						
EQ TYPE = 1	BALANCE																						
BALANCE	0.0 ~ 100.0 %																						
DISTORTION	BALANCE																						
0.0 ~ 100.0 %	0.0 ~ 100.0 %																						

*1: L → R, L ← R, L ↔ R, L ↔ R, L-TURN, R-TURN
 *2: THRU, 32 Hz ~ 1.0 kHz
 *3: 1.0 ~ 16 kHz, THRU



MONO IN [L/R MIX] - MULTI

Memory No.	Program Name	Function Key	Parameter										
			1	2	3	4	5	6	7	8	9	10	11
28	MULTI (CHO & REV)	<input type="checkbox"/> PARAM <input type="checkbox"/> INT PARAM	CO DI CH RV	CO DI CH RV	CO DI CH RV	CO DI CH RV	CH. FREQ	CH. DM DEPTH	RV. RT	RV. HIGH	RV. DLY	RV. MIX	
			CO. CO	CO. DI	CO. CH	CO. RV	0.05 ~ 40.00 Hz	0 ~ 100 %	0.3 ~ 480.0 s	0.1 ~ 1.0	0.1 ~ 1000.0 ms	0 ~ 100 %	
			CO	CO. DI	CO. CH	CO. RV	0.60 Hz	60 %	2.4 s	0.6	10.0 ms	25 %	
			CO. ATTACK	CO. RELS	CO. THRSLD	CO. RATIO	DI. DIST	DI. MID F	DI. TRBL	TRG. LEVEL	RELEASE		
			1 ~ 40 ms	10 ~ 1000 ms	-42 ~ -12 dB	1.0 ~ 20.0	0 ~ 100 %	250 Hz ~ 5.6 kHz	-12 ~ 12 dB	0 ~ 100	3 ~ 24000 ms		
			23 ms	200 ms	-15 dB	5.0	100 %	900 Hz	0 dB	65	106 ms		
			EQ TYPE = 1	BALANCE									
			EQ TYPE = 1	BALANCE									
			0.0 ~ 100.0 %	0.0 ~ 100.0 %									
			CO DI SY RV	CO DI SY RV	CO DI SY RV	CO DI SY RV	SY FREQ	SY DEPTH	RV. RT	RV. HIGH	RV. DLY	RV. MIX	
CO. CO	CO. DI	CO. SY	CO. RV	0.05 ~ 40.0 Hz	0 ~ 100 %	0.3 ~ 480.0 s	0.1 ~ 1.0	0.1 ~ 1000.0 ms	0 ~ 100 %				
CO	CO. DI	CO. SY	CO. RV	0.85 Hz	50 %	0.4 s	0.6	40.0 ms	30 %				
CO. ATTACK	CO. RELS	CO. THRSLD	CO. RATIO	DI. DIST	DI. MID F	DI. TRBL	TRG. LEVEL	RELEASE					
1 ~ 40 ms	10 ~ 1000 ms	-42 ~ -12 dB	1.0 ~ 20.0	0 ~ 100 %	250 Hz ~ 5.6 kHz	-12 ~ 12 dB	0 ~ 100	3 ~ 24000 ms					
23 ms	500 ms	-12 dB	7.0	100 %	900 Hz	0 dB	58	150 ms					
EQ TYPE = 1	BALANCE												
EQ TYPE = 1	BALANCE												
0.0 ~ 100.0 %	0.0 ~ 100.0 %												
29	MULTI (SYM + REV)	<input type="checkbox"/> PARAM <input type="checkbox"/> INT PARAM	CO DI EX RV	CO DI EX RV	CO DI EX RV	CO DI EX RV	EX. HPF F	EX. ENHANCE	EX. MIX LVL	RV. RT	RV. HIGH	RV. DLY	RV. MIX
			CO. CO	CO. DI	CO. EX	CO. RV	500 Hz ~ 16 kHz	0 ~ 100 %	0 ~ 100 %	0.3 ~ 480.0 s	0.1 ~ 1.0	0.1 ~ 1000.0 ms	0 ~ 100 %
			CO	CO. DI	CO. EX	CO. RV	4.0 kHz	50 %	60 %	1.2 s	0.7	20.0 ms	20 %
			CO. ATTACK	CO. RELS	CO. THRSLD	DI. RATIO	DI. DIST	DI. MID F	DI. TRBL	TRG. LEVEL	RELEASE		
			1 ~ 40 ms	10 ~ 1000 ms	-42 ~ -12 dB	1.0 ~ 20.0	0 ~ 100 %	250 Hz ~ 5.6 kHz	-12 ~ 12 dB	0 ~ 100	3 ~ 24000 ms		
			20 ms	200 ms	-12 dB	7.0	100 %	900 Hz	0 dB	10	106 ms		
			EQ TYPE = 1	BALANCE									
			EQ TYPE = 1	BALANCE									
			0.0 ~ 100.0 %	0.0 ~ 100.0 %									
			CO DI SY RV	CO DI SY RV	CO DI SY RV	CO DI SY RV	SY FREQ	SY DEPTH	RV. RT	RV. HIGH	RV. DLY	RV. MIX	
CO. CO	CO. DI	CO. SY	CO. RV	0.05 ~ 40.0 Hz	0 ~ 100 %	0.3 ~ 480.0 s	0.1 ~ 1.0	0.1 ~ 1000.0 ms	0 ~ 100 %				
CO	CO. DI	CO. SY	CO. RV	0.85 Hz	50 %	0.4 s	0.6	40.0 ms	30 %				
CO. ATTACK	CO. RELS	CO. THRSLD	CO. RATIO	DI. DIST	DI. MID F	DI. TRBL	TRG. LEVEL	RELEASE					
1 ~ 40 ms	10 ~ 1000 ms	-42 ~ -12 dB	1.0 ~ 20.0	0 ~ 100 %	250 Hz ~ 5.6 kHz	-12 ~ 12 dB	0 ~ 100	3 ~ 24000 ms					
23 ms	500 ms	-12 dB	7.0	100 %	900 Hz	0 dB	58	150 ms					
EQ TYPE = 1	BALANCE												
EQ TYPE = 1	BALANCE												
0.0 ~ 100.0 %	0.0 ~ 100.0 %												
30	MULTI (EXC & REV)	<input type="checkbox"/> PARAM <input type="checkbox"/> INT PARAM	CO DI EX RV	CO DI EX RV	CO DI EX RV	CO DI EX RV	EX. HPF F	EX. ENHANCE	EX. MIX LVL	RV. RT	RV. HIGH	RV. DLY	RV. MIX
			CO. CO	CO. DI	CO. EX	CO. RV	500 Hz ~ 16 kHz	0 ~ 100 %	0 ~ 100 %	0.3 ~ 480.0 s	0.1 ~ 1.0	0.1 ~ 1000.0 ms	0 ~ 100 %
			CO	CO. DI	CO. EX	CO. RV	4.0 kHz	50 %	60 %	1.2 s	0.7	20.0 ms	20 %
			CO. ATTACK	CO. RELS	CO. THRSLD	DI. RATIO	DI. DIST	DI. MID F	DI. TRBL	TRG. LEVEL	RELEASE		
			1 ~ 40 ms	10 ~ 1000 ms	-42 ~ -12 dB	1.0 ~ 20.0	0 ~ 100 %	250 Hz ~ 5.6 kHz	-12 ~ 12 dB	0 ~ 100	3 ~ 24000 ms		
			20 ms	200 ms	-12 dB	7.0	100 %	900 Hz	0 dB	10	106 ms		
			EQ TYPE = 1	BALANCE									
			EQ TYPE = 1	BALANCE									
			0.0 ~ 100.0 %	0.0 ~ 100.0 %									
			CO DI SY RV	CO DI SY RV	CO DI SY RV	CO DI SY RV	SY FREQ	SY DEPTH	RV. RT	RV. HIGH	RV. DLY	RV. MIX	
CO. CO	CO. DI	CO. SY	CO. RV	0.05 ~ 40.0 Hz	0 ~ 100 %	0.3 ~ 480.0 s	0.1 ~ 1.0	0.1 ~ 1000.0 ms	0 ~ 100 %				
CO	CO. DI	CO. SY	CO. RV	0.85 Hz	50 %	0.4 s	0.6	40.0 ms	30 %				
CO. ATTACK	CO. RELS	CO. THRSLD	CO. RATIO	DI. DIST	DI. MID F	DI. TRBL	TRG. LEVEL	RELEASE					
1 ~ 40 ms	10 ~ 1000 ms	-42 ~ -12 dB	1.0 ~ 20.0	0 ~ 100 %	250 Hz ~ 5.6 kHz	-12 ~ 12 dB	0 ~ 100	3 ~ 24000 ms					
23 ms	500 ms	-12 dB	7.0	100 %	900 Hz	0 dB	58	150 ms					
EQ TYPE = 1	BALANCE												
EQ TYPE = 1	BALANCE												
0.0 ~ 100.0 %	0.0 ~ 100.0 %												

Memory No.	Program Name	Function Key	Parameter											
			1	2	3	4	5	6	7	8	9	10	11	
31	PLATE + HALL	PARAM	PLT RT	PLT HIGH	PLT DIFF	PLT DLY	HAL RT	HAL HIGH	HAL DIFF	HAL DLY				
			0.3 ~ 480.0 s	0.1 ~ 1.0	0 ~ 10	0.1 ~ 1000.0 ms	0.3 ~ 480.0 s	0.1 ~ 1.0	0 ~ 10	0.1 ~ 1000.0 ms				
		MT PARAM	OUT MODE	PLT LPF	HAL LPF									
			ST, MONO x 2	* 2	* 2									
		EXCITR ASSIGN	1	2										
			PLT RT	BALANCE										
			0.0 ~ 100.0 %	0.0 ~ 100.0 %										
		32	ER + REV	PARAM	ER TYPE	ROOM SIZE	LIVENESS	ER DIFF	ER DLY	REV TIME	HIGH	REV DIFF	REV DLY	
					* 1	0.1 ~ 25.0	0 ~ 10	0 ~ 10	0.1 ~ 1000.0 ms	0.3 ~ 480.0 s	0.1 ~ 1.0	0 ~ 10	0.1 ~ 1000.0 ms	
				MT PARAM	OUT MODE	REV LPF								
ST, MONO x 2	* 2													
EXCITR ASSIGN	1			2										
	ER TYPE			BALANCE										
	0.0 ~ 100.0 %			0.0 ~ 100.0 %										
33	ECHO + REV			PARAM	Lch DLY	Lch F. B.	Rch DLY	Rch F. B.	ECHO HIGH	REV TIME	REV HIGH	REV DIFF	REV DLY	
					0.1 ~ 1000.0 ms	- 99 ~ +99 %	0.1 ~ 1000.0 ms	- 99 ~ +99 %	0.1 ~ 1.0	0.3 ~ 480.0 s	0.1 ~ 1.0	0 ~ 10	0.1 ~ 1000.0 ms	
				MT PARAM	OUT MODE	LINI DLY	RINI DLY	REV LPF						
		ST, MONO x 2	0.1 ~ 1000.0 ms		0.1 ~ 1000.0 ms	* 2								
		EXCITR ASSIGN	1	2										
			Lch DLY	BALANCE										
			0.0 ~ 100.0 %	0.0 ~ 100.0 %										

* 1: S - HALL, L - HALL, RANDOM, REVERSE, PLATE, SPRING

* 2: 1.0 ~ 16 kHz, THRU

Memory No.	Program Name	Function Key	Parameter												
			1	2	3	4	5	6	7	8	9	10	11		
34	CHORUS + REV		MOD. FRQ	DM DEPTH	AM DEPTH	REV TIME	HIGH	REV DIFF	REV DLY						
			0.05 ~ 40.00 Hz	0 ~ 100 %	0 ~ 100 %	0.3 ~ 480 s	0.1 ~ 1.0	-0 ~ 10	0.1 ~ 1000.0 ms						
			0.20 Hz	50 %	40 %	2.6 s	0.5	5	30.0 ms						
			OUT MODE	REV LPF											
			ST, MONO x 2	* 1											
			ST	8.0 KHZ											
			1	2											
			MOD. FRO	BALANCE											
			0.0 ~ 100.0 %	0.0 ~ 100.0 %											
35	PAN + PAN		1 PAN TYP	1 SPEED	1 F/R DPT	1 L/R DPT	1 DLY	2 PAN TYP	2 SPEED	2 F/R DPT	2 L/R DPT	2 DLY	PHASE		
			* 2	0.05 ~ 40.00 Hz	0 ~ 100 %	0 ~ 100 %	0.1 ~ 1000.0 ms	* 2	0.05 ~ 40.00 Hz	0 ~ 100 %	0 ~ 100 %	0 ~ 100 %	0.1 ~ 1000.0 ms	* 3	
			L → R	0.50 Hz	100 %	100 %	0.1 ms	L ↔ R	0.50 Hz	100 %	100 %	50 %	0.1 ms	0.0 deg	
			NOT AVAILABLE												

* 1: 1.0 ~ 16 kHz, THRU
 * 2: L → R, L ↔ R, L ↔ R, L ↔ R, L - TURN, R - TURN
 * 3: -180.0 ~ +180.0 deg

STEREO IN

Memory No.	Program Name	Function Key	Parameter										
			1	2	3	4	5	6	7	8	9	10	11
36	COMPRESSOR	PARAM	ATTACK	RELEASE	THRESHOLD	RATIO	EXPAND THRS	EXPND RATIO	DELAY	DET.DLY			
			1 ~ 40 ms	10 ~ 2000 ms	-48 ~ -6 dB	1.0 ~ 20.0	-72 ~ -30 dB	1.0 ~ 5.0	0.1 ~ 2300.0 ms	-50.0 ~ 50.0 ms			
			18 ms	200 ms	-24 dB	3.0	-42 dB	2.0	0.1 ms	0.0 ms			
			DET. HPF										
37	LO LVL EXPANDER	PARAM	ATTACK	BALANCE	RATIO	DELAY							
			0.0 ~ 100.0 %	0.0 ~ 100.0 %	1.0 ~ 5.0	0.1 ~ 2300.0 ms							
			-72 ~ -30 dB	2.0	0.1 ms								
			-42 dB										
38	EXCITER	PARAM	THRESHOLD	BALANCE	ENHANCE	MIX LVL	DELAY						
			0.0 ~ 100.0 %	0.0 ~ 100.0 %	0 ~ 100 %	0 ~ 100 %	0.1 ~ 1000.0 ms						
			500 Hz ~ 16 kHz	50 %	50 %	50 %	0.1 ms						
			1.6 kHz										
			EQ TYPE = 1	BALANCE TYPE = 1									
			EQ TYPE = 1	BALANCE TYPE = 1									
			EQ TYPE = 1	BALANCE TYPE = 1									

* 1: THRU, 500 Hz ~ 8.0 kHz

STEREO IN

Memory No.	Program Name	Function Key	Parameter																					
			1	2	3	4	5	6	7	8	9	10	11											
39	STEREO PITCH	PARAM	PITCH	PITCH FINE	DELAY	FB GAIN																		
			-24 ~ 24	-100 ~ +100	0.1 ~ 2300.0 ms	-99 ~ +99 %																		
			0	0	0.1 ms	0 %																		
			BASE KEY																					
			OFF, C 1 ~ C 6																					
			C 3																					
			EQ TYPE = 1																					
			BALANCE																					
			0.0 ~ 100.0 %	0.0 ~ 100.0 %																				
			REC. MODE	TRG. DLY	RECORD	OVER DUB	START	END	PITCH	PITCH FINE														
MANUAL, AUTO	-2900 ~ 1000 ms			0 ~ 2900 ms	0 ~ 2900 ms	-24 ~ 24	-100 ~ +100																	
AUTO	-50 ms			0	2900 ms	0	0																	
INPUT TRG	ANALOG TRG	TRG. MSK	BASE KEY																					
OFF, ON	OFF, ON	8 ~ 3000 ms	OFF, C 1 ~ C 6																					
OFF	OFF	99 ms	C 3																					
EQ TYPE = 1																								
1	2																							
BALANCE																								
0.0 ~ 100.0 %	0.0 ~ 100.0 %																							
REC. MODE	BALANCE																							
0.0 ~ 100.0 %	0.0 ~ 100.0 %																							
EQ TYPE = 1																								
1	2																							
BALANCE																								
0.0 ~ 100.0 %	0.0 ~ 100.0 %																							
EQ TYPE = 1																								
1	2																							
BALANCE																								
0.0 ~ 100.0 %	0.0 ~ 100.0 %																							
EQ TYPE = 1																								
1	2																							
BALANCE																								
0.0 ~ 100.0 %	0.0 ~ 100.0 %																							
EQ TYPE = 1																								
1	2																							
BALANCE																								
0.0 ~ 100.0 %	0.0 ~ 100.0 %																							
EQ TYPE = 1																								
1	2																							
BALANCE																								
0.0 ~ 100.0 %	0.0 ~ 100.0 %																							
EQ TYPE = 1																								
1	2																							
BALANCE																								
0.0 ~ 100.0 %	0.0 ~ 100.0 %																							
EQ TYPE = 1																								
1	2																							
BALANCE																								
0.0 ~ 100.0 %	0.0 ~ 100.0 %																							
EQ TYPE = 1																								

EQUALIZER

		PARAMETER														
TYPE	MEM No.	Program No.	Function Key	1	2	3	4	5	6	7	8	9	10			
1	1 ~ 30, 36 ~ 40	[MONO IN / STEREO] TYPE Displays 2 ~ 9 on EQ Displays 10 ~ 18 on DF LEVEL Displays 10 ~ 15, 19 on DF LFO	EQ / OFF / D. FLT EQ / OFF / D. FLT OFF 11 FLT TYPE * 3 LPF	EQ / OFF / D. FLT	LOW EQ	LOW FRQ	LOW GAIN	LOW Q	HI EQ	HI FRQ	HI GAIN	HI Q	CTL TYPE			
				PEAK, SHLV	32 ~ 2.2 kHz	-15 ~ 15 dB	0.1 ~ 5.0	PEAK, SHLV	500 ~ 16 kHz	-15 ~ 15 dB	0.1 ~ 5.0	500 ~ 16 kHz	0.1 ~ 5.0	0.1 ~ 5.0	* 2	
				OFF	100 Hz	0 dB	0.7	PEAK	10 kHz	0 dB	0.7	10 kHz	0.7	0.7	LFO	
				11	12	13	14	15	16	17	18	19				
				↑	F CENTER	F DEPTH	GAIN * 4	Q	SHIFT	SENSITIVITY	DECAY	LFO FRQ				
					32 ~ 16 kHz	0 ~ 8 oct	* 1	LOW, HIGH	UP, DOWN	1 ~ 10	1 ~ 10	0.1 ~ 10.0 Hz				
					1.0 kHz	4 oct	-12 dB	HIGH	DOWN	5	5	2.5 Hz				
2	31 ~ 35	[2 CHIN] TYPE Displays 2 ~ 17 on EQ Displays 18 ~ 25 on DF LEVEL Displays 18 ~ 22, 26 on DF LFO	EQ / OFF / D. FLT EQ / OFF / D. FLT OFF 11 RLOW F 32 ~ 2.2 kHz 100 Hz 21 F DEPTH 0 ~ 8 oct 4 oct	EQ / OFF / D. FLT	LLOW EQ	LLOW F	LLOW G	LLOW Q	LHIEQ	LHIF	LHIG	LHIQ	RLOW EQ			
				PEAK, SHLV	32 ~ 2.2 kHz	-15 ~ 15 dB	0.1 ~ 5.0	PEAK, SHLV	500 ~ 16 kHz	-15 ~ 15 dB	0.1 ~ 5.0	500 ~ 16 kHz	-15 ~ 15 dB	0.1 ~ 5.0	PEAK / SHLV	
				OFF	100 Hz	0 dB	0 dB	0.7	PEAK	10 kHz	0 dB	0.7	10 kHz	0 dB	0.7	PEAK
				11	12	13	14	15	16	17	18	19	20			
				↑	RLOW G	RLOW Q	RHIEQ	RHIF	RHIG	RHIQ	CTL TYPE	FLT TYPE	F CENTER			
					32 ~ 2.2 kHz	-15 ~ 15 dB	0.1 ~ 5.0	PEAK, SHLV	500 ~ 16 kHz	-15 ~ 15 dB	0.1 ~ 5.0	0.1 ~ 5.0	0.1 ~ 5.0	* 2	* 3	32 ~ 16 kHz
					100 Hz	0 dB	0.7	PEAK	10 kHz	0 dB	0.7	0.7	0.7	LFO	LPF	1.0 kHz
					21	22	23	24	25	26	27					
				↑	F DEPTH	GAIN * 4	Q	SHIFT	SENSITIVITY	DECAY	LFO FRQ.					
					0 ~ 8 oct	* 1	LOW, HIGH	UP, DOWN	1 ~ 10	1 ~ 10	0.1 ~ 10.0 Hz					

* 1 = -18, -12, -6, 6, 12, 18 (dB)
 * 2 = LEVEL, LFO
 * 3 = LPF, HPF, BPF, PEQ
 * 4 = Display on FLT TYPE = PEQ only

BALANCE

TYPE	MEM No.	Program No.	Function Key	PARAMETER																			
				1	2	3	4	5	6	7	8	9	10										
1	1 ~ 30, 36 ~ 40	[MONO IN / STEREO] TYPE	BAL	BALANCE	OUT LVL																		
				0 ~ 100 %	0 ~ 200 %																		
				100 %	100 %																		
2	31 ~ 35	[2 - CH, IN] TYPE	BAL	BALANCE 1	OUT LVL 1	BALANCE 2	OUT LVL 2																
				0 ~ 100 %	0 ~ 200 %	0 ~ 100 %	0 ~ 200 %																
				100 %	100 %	100 %	100 %																

MIDI DATA FORMAT

1. Transmitting Conditions

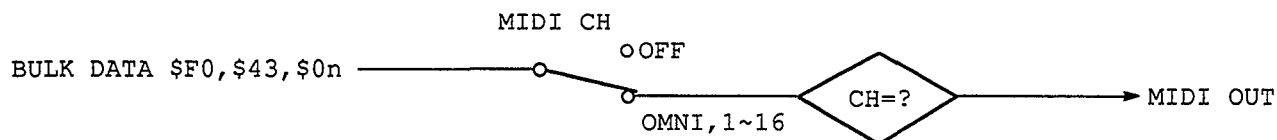

2. Transmitting Data

2.1 System information

1) System Exclusive Messages

① MEMORY BULK DATA

MIDI DATA FORMAT Transmission is enabled on the MIDI channel of the currently selected bank. Data is transmitted when BULK OUT 1 is displayed and BULK OUT is executed, and when the MEMORY BULK DUMP REQUEST message is received. The data to be transmitted is the program of the memory number indicated. If the memory number is " * " , data is sent from Memory 41 to Memory 99 in succession.

① DONNEES DE BLOC DE MEMOIRES

La transmission du format des données MIDI (MIDI DATA FORMAT) est validée sur le canal MIDI du bank actuellement sélectionné. Les données sont transmises lorsque BULK OUT1 est affiché et BULK OUT est exécuté ainsi que lorsque le message "MEMORY BULK DUMP REQUEST" (demande de vidage de bloc de mémoire) est reçu. Les données à transmettre sont le programme du numéro de mémoire indiqué. Si le numéro de mémoire est "*", les données sont transmises de la mémoire 41 à la mémoire 99 à la suite les unes des autres.

① Speicherblockdaten

Die Übertragung erfolgt auf dem Kanal der gerade angewählten Bank. Wird die Meldung "BULK OUT 1" angezeigt und geht ein Blockabwurfbefehl (Bulk dump request) ein, so wird ein Blockabwurf (Bulk dump) ausgeführt. Es werden dann die Daten übertragen, deren Speichernummer gerade angezeigt wird. Lautet die Speichernummer "*", werden alle Benutzer-Speicher (41~99) der Reihe nach gesendet.

STATUS	11110000(FOH)	
ID No.	01000011(43H)	
SUB STATUS	0000nnnn(OnH)	n=0(channel number1)~15 (channel number16)
FORMAT No.	01111110(7EH)	
BYTE COUNT	00000010(02H)	
BYTE COUNT	00001010(OAH)	
	01001100(4CH)"L"	
	01001101(4DH)"M"	
	00100000(20H)SPACE	
	00100000(20H)SPACE	
	00111000(38H)"8"	
	00110011(33H)"3"	
	00110111(37H)"7"	
	00111000(38H)"8"	
DATA NAME	01001101(4DH)"M"	
MEMORY	Ommmmmmmm	M=1(MEMORY No.1)~99(MEMORY No.99)
DATA	Oddddddd	
	Oddddddd	256BYTE
CHECK SUM	Oeeeeeee	
EOX	11110111(F7H)	

② Bank Program Change Chart Bulk Data

Transmission is enabled on the MIDI channel of the currently selected bank. Data is transmitted when BULK OUT 1 is displayed and BULK OUT is executed, and when the PROGRAM CHANGE CHART BULK DUMP REQUEST message is received. The data to be transmitted is the program change chart (the chart showing the correspondence between program numbers and memory numbers). If the bank number is " * ", the data from banks 1 - 4 (A - D) is transmitted in succession.

② Données en bloc de la table des changements de programme du bank (Bank Programm Change Chart Bulk Data)

La transmission est possible sur le canal MIDI du bank actuellement sélectionné. Les données sont transmises lorsque BULK OUT1 est affiché et BULK OUT est exécuté ainsi que lorsque le message PROGRAM CHANGE CHART BULK DUMP REQUEST (demande de vidage en bloc de la table des changements de programme) est reçu. Les données à transmettre sont le tableau des changements de programme (le tableau indiquant la correspondance entre le numéros de programme et les numéros de mémoire). Si le numéro de programme est "*", les données des banks 1-4 (A-D) sont transmises les unes après les autres.

② Blockdaten der Programmwechsel-Zuordnungstabelle einer Bank

Die Übertragung erfolgt auf dem Kanal der gerade angewählten Bank. Wird die Meldung "BULK OUT 2" angezeigt und geht ein Blockabwurfbehl der Programmwechsel-Zuordnungstabelle (Program change chart bulk dump request) ein, so wird der Abwurf ausgeführt. Es werden dann die Daten der Programmwechsel-Zuordnungstabelle übertragen. (In dieser Tabelle wird jeder Speichernummer des SPX1000 eine MIDI-Programmwechselnummer zugeordnet). Lautet die Banknummer "*", werden die Daten aller Bänke (A~D) der Reihe nach gesendet.

```

STATUS          11110000(FOH)
ID No.          01000011(43H)
SUB STATUS      0000nnnn(0nH)          n=0(channel number1)~15 (channel number16)
FORMAT No.      01111110(7EH)
BYTE COUNT      00000001(01H)
BYTE COUNT      00001010(OAH)
                 01001100(4CH)"L"
                 01001101(4DH)"M"
                 00100000(20H)SPACE
                 00100000(20H)SPACE
                 00111000(38H)"8"
                 00110011(33H)"3"
                 00110111(37H)"7"
                 00111000(38H)"8"
DATA NAME       01010100(54H)"T"
BANK No.        Ozzzzzzz              Z=BANK 1~4(1=A, 2=B, 3=C, 4=D)
DATA            Oddddddd
                 ↘ ┌───┐ 128BYTE
                 Oddddddd
CHECK SUM       Oeeeeeee
EOX             11110111(F7H)

```

③ User ER Pattern Bulk Data

Transmission is enabled on the MIDI channel of the currently selected bank. Data is transmitted when BULK OUT 2 is displayed and BULK OUT is executed, and when the USER ER PATTERN BULK DUMP REQUEST message is received. The data to be transmitted is that of the indicated pattern number. If the pattern number is " * " , patterns 1 - 4 (A - D) are transmitted in succession.

③ Données en bloc de motifs USER ER.

La transmission est validée sur le canal MIDI du bank actuellement sélectionné. Les données sont transmises lorsque BULK OUT 2 est affiché et BULK OUT est exécuté ainsi que lorsque le message USER ER PATTERN BULK DUMP REQUEST (demande de vidage en bloc de motifs de réflexions précoces de l'utilisateur) est reçu. Les données à transmettre sont celles des numéros de motifs indiqués. Si le numéro de motif est "*", les motifs 1-4 (A-D) sont transmis l'un après l'autre.

③ User ER-Programmblockdaten

Die Übertragung erfolgt auf dem Kanal der gerade angewählten Bank. Wird die Meldung "BULK OUT 2" angezeigt und geht ein Blockabwurfbefehl der Erstreflexions-Musterprogramme (User ER pattern bulk dump request) ein, so wird der Abwurf ausgeführt. Es werden dann die Daten des angezeigten Speichers übertragen. Lautet die Speichernummer "*", werden die Daten aller vier User-Speicher (A~D) der Reihe nach gesendet.

```

STATUS          11110000(F0H)
ID No.          01000011(43H)
SUB STATUS      0000nnnn(0nH)          n=0 (Channel No. 1)~15 (Channel No. 16)
FORMAT No.      01111110(7EH)
BYTE COUNT      00000001(01H)
BYTE COUNT      01101110(6EH)
                 01001100(4CH)"L"
                 01001101(4DH)"M"
                 00100000(20H)SPACE
                 00100000(20H)SPACE
                 00111000(38H)"8"
                 00110011(33H)"3"
                 00110111(37H)"7"
                 00111000(38H)"8"
DATA NAME       01000101(45H)"E"
ER PATTERN No.  Ozzzzzzz              Z=ER PATTERN 1~4(1=A, 2=B, 3=C, 4=D)
DATA            0ddddd            ┌ 228BYTE
                 〽
                 0ddddd
CHECK SUM       Oeeeeeee
EOX             11110111(F7H)
    
```

④ System Setup Bulk Data

Transmission is enabled on the MIDI channel of the currently selected bank. Data is transmitted when BULK OUT 2 is displayed and BULK OUT is executed, and when the SYSTEM SETUP DATA DUMP REQUEST message is received.

④ Données en bloc de configuration du système

La transmission est validée sur le canal MIDI du bank actuellement sélectionné. Les données sont transmises lorsque BULK OUT 2 est affiché et BULK OUT est exécuté ainsi que lorsque le message SYSTEM SETUP DATA DUMP REQUEST (demande de vidage des données de configuration du système) est reçu. -3-

④ Systemblockdaten

Die Übertragung erfolgt auf dem Kanal der gerade angewählten Bank. Die Daten werden nur gesendet, wenn "BULK OUT 2" angezeigt und wenn ein Systemdaten-Abwurfbefehl (System setup data dump request) eingeht.

```

STATUS          11110000(F0H)
ID No.          01000011(43H)
SUB STATUS      0000nnnn(0nH)          n=0(Channel NO.1)~15(Channel No.16)
FORMAT No.     01111110(7EH)
BYTE COUNT     00000000(00H)
BYTE COUNT     00011100(1CH)
                01001100(4CH)"L"
                01001101(4DH)"M"
                00100000(20H)SPACE
                00100000(20H)SPACE
                00111000(38H)"8"
                00110011(33H)"3"
                00110111(37H)"7"
                00111000(38H)"8"
DATA NAME      01010011(53H)"S"
                00100000(20H)SPACE
SOFT VERSION No. Ovvvvvvv
SOFT VERSION No. Orrrrrrr
DATA          Oddddddd
                ↘
                Oddddddd  ] 16BYTE
CHECK SUM     Oeeeeeee
EOX           11110111(F7H)

```

⑤ 59 Memory/All Banks/All ER Patterns/System Setup Data/Bulk Data

Transmission is enabled on the MIDI channel of the currently selected bank. Data is transmitted when BULK OUT 1 is displayed and ALL BULK OUT is executed. The data to be transmitted is the programs of Memory Nos. 41 - 99, all programs of the 4 bank change charts, the four ER patterns, and the System Setup data. The transmission order is as follows: programs of Memory Nos. 41 to 99, Bank A program change chart to Bank D program change chart, ER pattern A to ER pattern D, and System Setup data.

⑤ Données en bloc de 59 mémoires /Tous les banks/Tous les motifs ER/ Données de configuration du système La transmission est validée sur le canal MIDI du bank actuellement sélectionné. Les données sont transmises lorsque BULK OUT1 est affiché et l'instruction ALL BULK OUT est exécutée. Les données à transmettre sont les programmes des mémoires Nos 41 - 99, tous les programmes des tables de changements de programmes des 4 banks, les quatres motifs ER et les données de configuration du système. L'ordre de transmission est le suivant: programmes de mémoires Nos 41 à 99, tables des changements de programmes des banks A à D, motifs ER A à D et données de configuration du

⑤ 59 Speicher/Alle Bänke/Alle ER-Speicher/System-Daten als Block

Die Übertragung erfolgt auf dem Kanal der gerade angewählten Bank. Die Daten werden nur gesendet, wenn "BULK OUT 1" angezeigt und wenn der Befehl "ALL BULK OUT" ausgeführt wird. Es werden folgende Daten übertragen: RAM-Speicher 41~99, alle Daten der vier Programmwechsel-Zuordnungstabellen, die vier User-ER Speicher und die System-Daten. Die Übertragungsreihenfolge ist: RAM-Speicher, Programmwechseltabelle A~D, ER-Speicher A~D und die System-Daten.

STATUS	11110000(F0H)	MEMORY 41	
ID No.	01000011(43H)		
SUB STATUS	0000nnnn(0nH)		n=0(Channel No.1)~15(Channel No.16)
FORMAT No.	01111110(7EH)		
BYTE COUNT	00000010(02H)		
BYTE COUNT	00001010(0AH)		
	01001100(4CH)"L"		
	01001101(4DH)"M"		
	00100000(20H)SPACE		
	00100000(20H)SPACE		
	00111000(38H)"8"		
	00110011(33H)"3"		
	00110111(37H)"7"		
	00111000(38H)"8"		
DATA NAME	01001101(4DH)"M"		
MEMORY No.	0mmmmmmmm	M=41(Memory No.41)~99(Memory No.99)	
DATA	0ddddddd	256BYTE	
	0ddddddd		
CHECK SUM	0eeeeeee		
EOX	11110111(F7H)		

STATUS	11110000(F0H)	MEMORY 42
EOX	11110111(F7H)	
	⋮	
STATUS	11110000(F0H)	MEMORY 99
EOX	11110111(F7H)	

STATUS	11110000(F0H)	BANK A	
ID No.	01000011(43H)		
SUB STATUS	0000nnnn(0nH)		n=0(Channel No.1)~15(Channel No.16)
FORMAT No.	01111110(7EH)		
BYTE COUNT	00000001(01H)		
BYTE COUNT	00001010(0AH)		
	01001100(4CH)"L"		
	01001101(4DH)"M"		
	00100000(20H)SPACE		
	00100000(20H)SPACE		
	00111000(38H)"8"		
	00110011(33H)"3"		
	00110111(37H)"7"		
	00111000(38H)"8"		
DATA NAME	01010100(54H)"T"		
BANK No.	0zzzzzzz	Z=BANK1~4(1=A,2=B,3=C,4=D)	



Continuous

DATA	Oddddddd	}	128BYTE
	Oddddddd		
CHECK SUM	Oeeeeeee		
EOX	11110111 (F7H)		

STATUS	11110000 (FOH)	}	BANK B
EOX	11110111 (F7H)		

STATUS	11110000 (FOH)	}	BANK C
EOX	11110111 (F7H)		

STATUS	11110000 (FOH)	}	BANK D
EOX	11110111 (F7H)		

STATUS	11110000 (FOH)	}	n=0(Channel No.1)~15(Channel No.16)
ID No.	01000011 (43H)		
SUB STATUS	0000nnnn (OnH)		
FORMAT NO.	01111110 (7EH)		
BYTE COUNT	00000001 (01H)		
BYTE COUNT	01101110 (6EH)		
	01001100 (4CH) "L"		
	01001101 (4DH) "M"		
	00100000 (20H) SPACE		
	00100000 (20H) SPACE		
	00111000 (38H) "8"		
	00110011 (33H) "3"		
	00110111 (37H) "7"		
	00111000 (38H) "8"		
DATA NAME	01000101 (45H) "E" ER PATTERN		
ER PATTERN No.	Ozzzzzzz Z=BANK1~4(1=A, 2=B, 3=C, 4=D)		
DATA	Oddddddd	}	228BYTE
	Oddddddd		
CHECK SUM	Oeeeeeee		
EOX	11110111 (F7H)		

ER PATTERN A

STATUS	11110000 (FOH)	}	ER PATTERN B
EOX	11110111 (F7H)		

STATUS	11110000 (FOH)	}	ER PATTERN C
EOX	11110111 (F7H)		

STATUS	11110000 (FOH)	}	ER PATTERN D
EOX	11110111 (F7H)		

STATUS	11110000	(F0H)	
ID No.	01000011	(43H)	
SUB STATUS	0000nnnn	(0nH)	n=0(Channel No.1)~15(Channel No.16)
FORMAT No.	01111110	(7EH)	
BYTE COUNT	00000000	(00H)	
BYTE COUNT	00011100	(1CH)	
	01001100	(4CH)	"L"
	01001101	(4DH)	"M"
	00100000	(20H)	SPACE
	00100000	(20H)	SPACE
	00111000	(38H)	"8"
	00110011	(33H)	"3"
	00110111	(37H)	"7"
	00111000	(38H)	"8"
DATA NAME	01010011	(53H)	"S"
	00100000	(20H)	
SOFT VERSION No.	Ovvvvvvv		
SOFT VERSION No.	orrrrrrr		
	0ddddddd		
	0ddddddd		
	0ddddddd		
CHECK SUM	Oeeeeeee		
EOX	11110111	(F7H)	

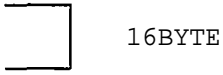

3.Receiving Conditions

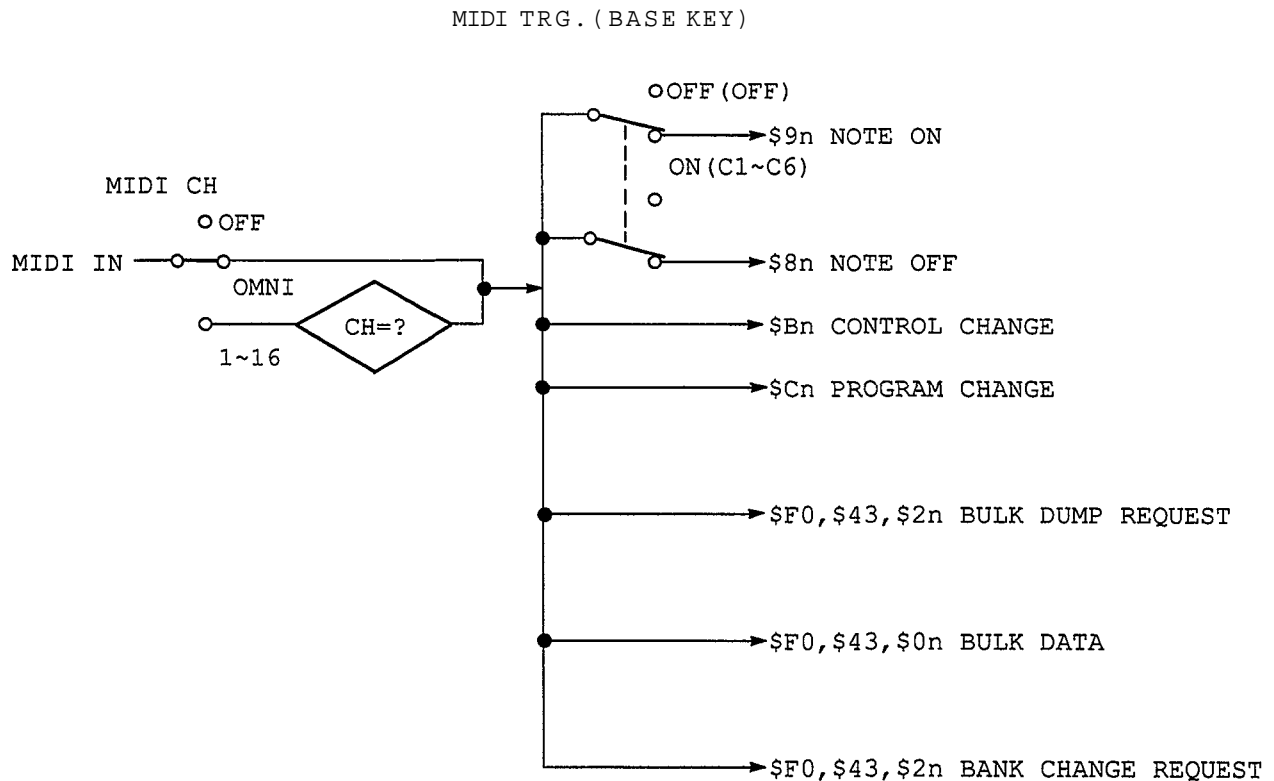

4. Reception Data

4-1. Channel information

1) Channel voice messages

① Note On

Reception is enabled on the MIDI channel of the currently selected bank. For programs of Memory Nos. 1 - 5 , 19 , and 26 , if the parameter of MIDI TRG. is ON, this is received as a trigger.

For programs of Memory Nos. 20 - 24 , 39 , and 40 , this is received as a message to control pitch variation. The velocity value is ignored. Reception is not possible when the Base Key parameter is OFF.

① Note activée

La réception est validée sur le canal MIDI du bank actuellement sélectionné. Pour les programmes de mémoire Nos 1-5, 19 et 26, si le paramètre de MIDI TRG. est ON, ceci est reçu en tant que message de déclenchement. Pour les programmes des mémoires Nos 20 - 24, 39 et 40, ceci est reçu en tant que message de contrôle de la variation de hauteur. La valeur de vélocité est ignorée. La réception n'est pas possible lorsque le paramètre "Base Key" est OFF.

① Note An

Der Empfang erfolgt auf dem Kanal der gerade angewählten Bank. Ist die MIDI TRIGGER-Funktion der Programme 1~5, 19 und 26 eingeschaltet, gelten die empfangenen Meldungen als Auslöser (Trigger).

Für die Programme 20~24, 39 und 40 werden die empfangenen Meldungen zur Steuerung der Tonhöhe verwendet. Die Anschlagdynamik wird nicht ausgewertet. Der Empfang ist nur möglich, wenn der BASE KEY-Parameter eingeschaltet ist.

STATUS	1001nnnn (9nH)	n=0(Channel No.1)~15(Channel No.16)
NOTE No.	0kkkkkkk	k=0(C-2)~127(G8)
VELOCITY	ovvvvvvv	v=0~127

② Note Off

This message is used when playback of the Memory No. 24 FREEZE 2 is finished. The velocity value is ignored. The reception conditions are the same as in ① NoteOn.

② Note désactivée

Ce message est utilisé lorsque la reproduction de la mémoire No 24 FREEZE 2 est terminée. La valeur de vélocité est ignorée. Les conditions de réception sont les mêmes que pour 1> Note activée.

② Note Aus

Diese Meldung ist nur am Ende der Wiedergabe des Programmes 24. Freeze 2 notwendig. Die Anschlagdynamik wird nicht ausgewertet. Die Empfangsbedingungen sind dieselben wie die der Note-An-Meldungen (1).

STATUS	1000nnnn (8nH)	n=0(Channel No.1)~15(Channel No.16)
NOTE No.	0kkkkkkk	k=0(C-2)~127(G8)
VELOCITY	ovvvvvvv	v=0~127

③ Control Change

Reception is enabled on the MIDI channel of the currently selected bank. When receiving, parameters can be controlled. Change them by using the corresponding controller based on the Control Assignment List.

③ Changements de commande

La réception est validée sur le canal MIDI du bank actuellement sélectionné. Pendant la réception, les paramètres peuvent être contrôlés. Les changer en utilisant les commandes correspondantes spécifiées dans la liste des assignations de commandes.

③ Steuerelementänderung

Der Empfang erfolgt auf dem Kanal der gerade angewählten Bank. Mit den Steuerelement-Meldungen kann man bestimmte Parameter steuern. Hierfür muß ein Steuerelement zugeteilt werden.

STATUS	1011nnnn (BnH)	n=0(CHANNEL NO.1)~15(CHANNEL NO.16)
CONTROL NO.	0ccccccc	c=0~120
CONTROL VALUE	0vvvvvvvv	v=0~127

④ Program Change

Reception is enabled on the MIDI channel of the currently selected bank. When receiving, the desired program can be loaded, based on the program change chart of that particular bank.

④ Changement de programme

La réception est validée sur le canal MIDI du bank actuellement sélectionné. Pendant la réception, un programme appartenant au bank sélectionné peut être chargé.

④ Programmwechsel

Der Empfang erfolgt auf dem Kanal der gerade angewählten Bank. Jede beliebige Speichernummer kann jeder beliebigen Programmwechselnummer zugeordnet werden.

STATUS	1100nnnn (CnH)	n=0(CHANNEL NO.1)~15(CHANNEL NO.16)
PROGRAM No.	0ppppppp	p=0~127

4-2. System Information

1) System exclusive messages

① Memory Bulk Dump Request

Reception is enabled on the MIDI channel of the currently selected bank. When this message is received, BULK OUT is executed for the program of the indicated memory number.

① Demande de vidage en bloc de mémoires

La réception est validée sur le canal MIDI du bank actuellement sélectionné. Lorsque ce message est reçu, BULK OUT est exécuté pour le programme du numéro de mémoire indiqué.

① Speicherblockabwurf-Befehl

Der Empfang erfolgt auf dem Kanal der gerade angewählten Bank. Sobald dieser Befehl eingeht, wird der Blockabwurf (Bulk out) für den gerade aufgerufenen Speicher ausgeführt.

STATUS	11110000 (F0H)	
ID No.	01000011 (43H)	
SUB STATUS	0010nnnn (2nH)	n=0(Channel No.1)~15(Channel No.16)
FORMAT No.	01111110 (7EH)	
	01001100 (4CH)"L"	
	01001101 (4DH)"M"	
	00100000 (20H)SPACE	
	00100000 (20H)SPACE	
	00111000 (38H)"8"	
	00110011 (33H)"3"	
	00110111 (37H)"7"	
	00111000 (38H)"8"	
DATA NAME	01001101 (4DH)"M"	
MEMORY No.	0mmmmmm	M=41(memoryNo.41)~99(MEMORYNo.99)
EOX	11110111 (F7H)	

② Program Change Chart Bulk Dump Request

Reception is enabled on the MIDI channel of the currently selected bank. When this message is received, BULK OUT is executed for the program change chart (the chart showing the correspondence between program numbers and memory numbers) of the indicated bank.

② Demande de vidage en bloc de la table des changements de programme

La réception est validée sur le canal MIDI du bank actuellement sélectionné. Lorsque ce message est reçu, BULK OUT est exécuté pour la table des changements de programme (la table indiquant la correspondance entre les numéros de programme et les numéros de mémoires) du bank indiqué.

② Blockdaten der Programmwechsel-Zuordnungstabelle einer Bank

Der Empfang erfolgt auf dem Kanal der gerade angewählten Bank. Geht ein Blockabwurfbefehl der Programmwechsel-Zuordnungstabelle (Program change chart bulk dump request) ein, so wird der Abwurf ausgeführt. Es werden dann die Daten der Programmwechsel-Zuordnungstabelle übertragen.

STATUS	11110000	(F0H)	
ID No.	01000011	(43H)	
SUB STATUS	0010nnnn	(2nH)	n=0(Channel No.1)~15(Channel No.16)
FORMATNo.	01111110	(7EH)	
	01001100	(4CH)"L"	
	01001101	(4DH)"M"	
	00100000	(20H)SPACE	
	00100000	(20H)SPACE	
	00111000	(38H)"8"	
	00110011	(33H)"3"	
	00110111	(37H)"7"	
	00111000	(38H)"8"	
DATA NAME	01010100	(54H)"T"	
BANKNo.	Ozzzzzzz		Z=BANK1~4(1=A,2=B,3=C,4=D)
EOX	11110111	(F7H)	

③ User ER Pattern Bulk Dump Request

Reception is enabled on the MIDI channel of the currently selected bank. When this message is received, BULK OUT is executed for the data of the indicated ER pattern number.

③ Demande de vidage en bloc des motifs ER de l'utilisateur

La réception est validée sur le canal MIDI du bank actuellement sélectionné. Lorsque ce message est reçu, BULK OUT est exécuté pour les données du numéro de motif ER indiqué.

③ User ER-Programmblockdaten

Der Empfang erfolgt auf dem Kanal der gerade angewählten Bank. Geht ein Blockabwurfbehl der Erstreflexions-Musterprogramme (User ER pattern bulk dump request) ein, so wird der Abwurf ausgeführt. Es werden dann die Daten des angezeigten Speichers übertragen.

STATUS	11110000	(F0H)	
ID No.	01000011	(43H)	
SUB STATUS	0010nnnn	(2nH)	n=0(Channel No.1)~15(Channel No.16)
FORMAT No.	01111110	(7EH)	
	01001100	(4CH)"L"	
	01001101	(4DH)"M"	
	00100000	(20H)SPACE	
	00100000	(20H)SPACE	
	00111000	(38H)"8"	
	00110011	(33H)"3"	
	00110111	(37H)"7"	
	00111000	(38H)"8"	
DATA NAME	01000101	(45H)"E"	
ER PATTERN No.	Ozzzzzzz		Z=ER PATTERN1~4(1=A,2=B,3=C,4=D)
EOX	11110111	(F7H)	

④ System Setup Data Bulk Dump Request

Reception is enabled on the MIDI channel of the currently selected bank. When this message is received, BULK OUT is executed for System Setup data.

④ Demande de vidage en bloc des données de configuration de système

La réception est validée sur le canal MIDI du bank actuellement sélectionné. Lorsque ce message est reçu, BULK OUT est exécuté pour les données de configuration du système.

④ Systemblockdaten

Er Empfang erfolgt auf dem Kanal der gerade angewählten Bank. Die Daten werden nur gesendet, wenn ein Systemdaten-Abwurfbefehl (System setup data dump request) eingeht.

STATUS	11110000	(F0H)	
ID No.	01000011	(43H)	
SUB STATUS	0010nnnn	(2nH)	n=0(Channel No.1)~15(Channel No.16)
FORMAT No.	01111110	(7EH)	
	01001100	(4CH)"L"	
	01001101	(4DH)"M"	
	00100000	(20H)SPACE	
	00100000	(20H)SPACE	
	00111000	(38H)"8"	
	00110011	(33H)"3"	
	00110111	(37H)"7"	
	00111000	(38H)"8"	
DATA NAME	01010011	(53H)"S"	
	00100000	(20H)	
EOX	11110111	(F7H)	

⑤ Bank Change Request

Reception is enabled on the MIDI channel of the currently selected bank. When this message is received, the desired bank can be switched to.

⑤ Demande de changement de bank

La réception est validée sur le canal MIDI du bank actuellement sélectionné. Lorsque ce message est reçu, le bank souhaité peut être sélectionné.

⑤ Bankanwahlbefehl

Er Empfang erfolgt auf dem Kanal der gerade angewählten Bank. Sobald dieser Befehl eingeht, kann die gewünschte Bank aufgerufen werden.

STATUS	11110000	(F0H)	
ID No.	01000011	(43H)	
SUB STATUS	0010nnnn	(2nH)	n=0(Channel No.1)~15(Channel No.16)
FORMAT No.	01111110	(7EH)	
	01001100	(4CH)"L"	
	01001101	(4DH)"M"	
	00100000	(20H)SPACE	
	00100000	(20H)SPACE	
	00111000	(38H)"8"	
	00110011	(33H)"3"	
	00110111	(37H)"7"	
	00111000	(38H)"8"	
DATA NAME	01010101	(55H)"U"	
BANK No.	Ozzzzzzz		Z=BANK1~4(1=A,2=B,3=C,4=D)
EOX	11110111	(F7H)	

⑥ Memory Bulk Data

Same as "Memory Bulk Data" for transmission.

⑥ Données de bloc de mémoire Idem que pour la transmission.

⑥ Speicherblockdaten

Siehe die "Speicherblockdaten" der Übertragung.

⑦ Bank Program Change Chart Bulk Data

Same as "Bank Program Change Chart Bulk Data" for transmission.

⑦ Données en bloc des tables de changements de programme du bank

Idem que pour la transmission

⑦ Blockdaten der Programmwechsel-Zuordnungstabelle einer Bank

Siehe die "Blockdaten der Programmwechsel-Zuordnungstabelle einer Bank" der Übertragung.

⑧ User ER Pattern Bulk Data

Same as "User ER Pattern Bulk Data" for transmission.

⑧ Données en bloc des motifs ER de l'utilisateur

Idem que pour la transmission.

⑧ User ER-Programmblockdaten

Siehe die "User ER-Programmblockdaten" der Übertragung.

⑨ System Setup Bulk Data

Same as "System Setup Bulk Data" for transmission.

⑨ Données en bloc de configuration du système

Idem que pour la transmission.

⑨ Systemblockdaten

Siehe die "Systemblockdaten" der Übertragung.

When receiving from the MIDI Data Filer MDF1, a computer, or other sources, the time interval between data exchanges (F7 ~ F0) with the other unit must be set to 30msec or longer.

Lorsque les données sont reçues d'un "MIDI Data Filer" MDF1, d'un ordinateur ou d'une autre source, l'intervalle d'attente entre les échanges de données (F7 ~ F0) avec l'autre appareil doit être fixé à 30 msec ou plus.

Sollen Daten vom MDF1 MIDI Data Filer, einem Computer oder anderen Geräten geladen werden, muß die Pause zwischen zwei Dateneinheiten (F7 ~ F0) zumindest 30mSek betragen.

Function . . .	Transmitted	Recognized	Remarks
Basic Default	: x	: 1 - 16 , off	: memorized
Channel Changed	: x	: 1 - 16 , off	:
Mode Default	: x	: OMNIoff/OMNIon	: memorized
Mode Messages	: x	: x	:
Mode Altered	: *****	: x	:
Note Number : True voice	: x : *****	: 0 - 127 : x	:
Velocity Note ON	: x	: x	:
Velocity Note OFF	: x	: x	:
After Key's	: x	: x	:
Touch Ch's	: x	: x	:
Pitch Bender	: x	: x	:
0 - 120	: x	: o	:
Control Change	:	:	:
Prog Change : True #	: x : *****	: o 0 - 127	: *1
System Exclusive	: o	: o	: Bulk Dump
System : Song Pos	: x	: x	:
System : Song Sel	: x	: x	:
Common : Tune	: x	: x	:
System :Clock	: x	: x	:
Real Time :Commands	: x	: x	:
Aux :Local ON/OFF	: x	: x	:
Aux :All Notes OFF	: x	: x	:
Mes- :Active Sense	: x	: o	: *2
sages:Reset	: x	: x	:
Notes:	*1 = For program 1 - 128, memory #1 - #99 is selected.		
	*2 = Active sensing is recognized only in "freeze".		

Mode 1 : OMNI ON , POLY Mode 2 : OMNI ON , MONO o : Yes
 Mode 3 : OMNI OFF , POLY Mode 4 : OMNI OFF , MONO x : No

BLOCK DIAGRAM

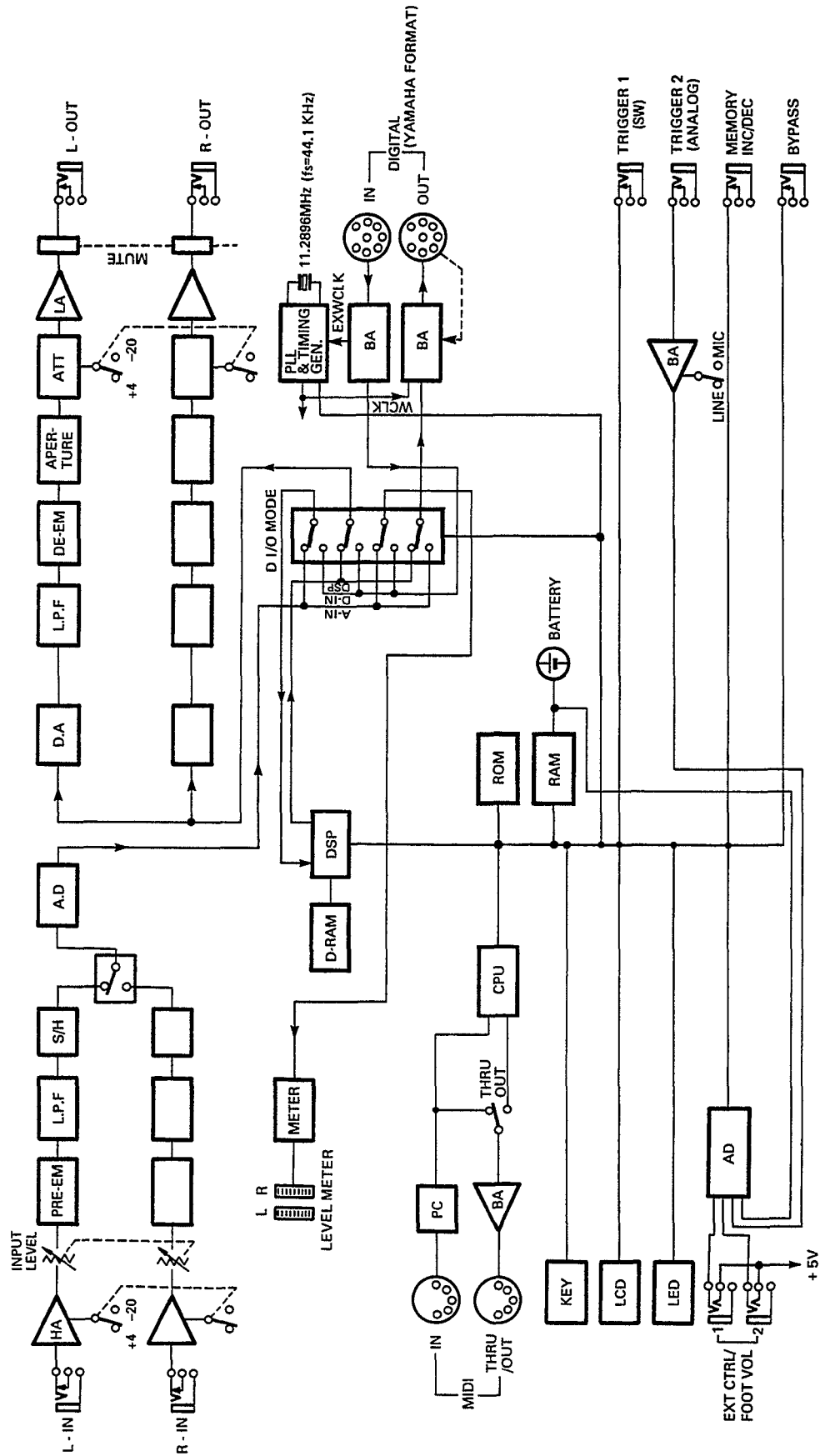

DIMENSIONS

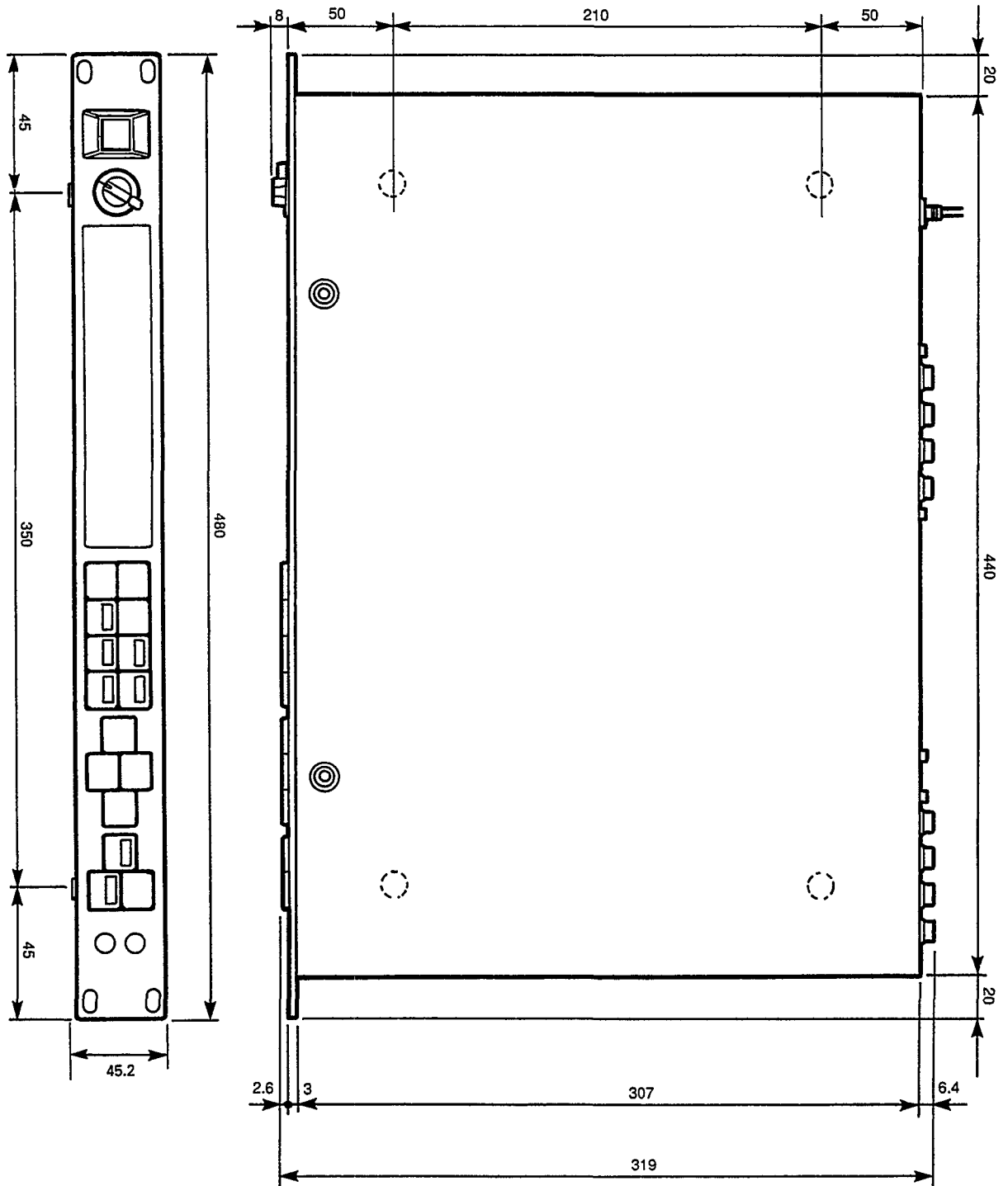

(unit: mm)

SPECIFICATIONS

ELECTRICAL CHARACTERISTICS

FREQ. RESPONSE	20Hz ~ 20kHz
DYNAMIC RANGE	90dB (TYPICAL)
DISTORTION	0.03% (@1kHz)

INPUT

NUMBER OF CHANNEL	UNBALANCED x 2(PHONE JACK)
NOMINAL LEVEL	+4/-20dBm SWITCHABLE
IMPEDANCE	50k Ω (STEREO-IN), 25k Ω (MONO)
LEVEL CONTROL	ROTARY CONTINUOUS

A/D CONVERSION

NUMBER OF CHANNELS	2 (AD CONVERTER x 1)
SAMPLING FREQ.	44.1kHz (EXCEPT D-IN)
QUANTIZATION	16bits

D/A CONVERSION

NUMBER OF CHANNELS	2
SAMPLING FREQ.	44.1 kHz (EXCEPT D-IN)
QUANTIZATION	16bits

OUTPUT

NUMBER OF CHANNEL	UNBALANCED x 2(PHONE JACK)
NOMINAL LEVEL	+4/-20dBm SWITCHABLE
IMPEDANCE	220 Ω

MEMORY

PRESETS (ROM)	1 ~40
USER MEMORY (RAM)	41 ~99

MIDI CONTROL

PROGRAM CHANGE (MEMORY SELECT)
 NOTE ON (MIDI BASE KEY SELECT, TRIGGER)
 CONTROL CHANGE
 BULKDUMP & LOAD (PARAMETER DUMP)

FRONT PANEL

CONTROLS KEYS	INPUT LEVEL PARAM. INC/DEC, PARAMETER, SCROLL BACK, LEVEL EQ, INT. PARAM, EXT CTRL ASSIGN STORE, MEMORY INC/DEC, RECALL, UTILITY, TRIGGER, BYPASS
DISPLAY	16 CHARA. x 2 LINE LCD 2 DIGIT 7 SEGMENT LED (MEM#) 2 ch. 8 SEGMENT LED (LEVEL METER)
CONNECTORS	EXT CTRL/FOOT VOL JACK x 2

REAR PANEL

CONNECTORS	INPUT (PHONE JACK x 2) OUTPUT (PHONE JACK x 2) MIDI IN, THRU/OUT (DIN 5P x 2) DIGITAL I/O (DIP 8P x 2) TRIGGER1 SW (PHONE JACK) TRIGGER2 SW (ANALOG) (PHONE JACK) MEMORY INC/DEC (PHONE JACK) BYPASS (PHONE JACK)
SWITCHES	INPUT LEVEL SW, OUTPUT LEVEL SW MIDI THRU/OUT SW TRIGGER2 (ANALOG) LEVEL SW

GENERAL

POWER SUPPLY	US & CANADA: 120V, 60Hz, 22W GENERAL: 220-240V, 50/60Hz, 22W
DIMENSIONS (W x H x D)	480 x 45.2 x 319 (mm)

•(0db=0.775V.r.m.s.
 •Specifications and appearance subject to change without notice.

CARACTERISTIQUES TECHNIQUES

CARACTERISTIQUES ELECTRIQUES

Réponse en fréquence	20Hz ~ 20kHz
Plage dynamique	90dB (TYPIQUE)
Distorsion	0,03% (à 1kHz)

ENTREE

Nombre de canaux	Asymétriques × 2 (Prise "Jack")
Niveau nominal	+4 / -20dBm (commutable)
Impédance	50kΩ (STEREO IN), 25kΩ (MONO)
Commande de niveau	Rotative continue

CONVERSION A/N

Nombre de canaux	2 (Convertisseur analogique/numérique × 1)
Fréquence d'échantillonnage	44,1kHz (sauf D-IN)
Quantification	16bits

CONVERSION N/A

Nombre de canaux	2
Fréquence d'échantillonnage	44,1kHz (sauf D-IN)
Quantification	16bits

SORTIE

Nombre de canaux	Asymétriques × 2 (Prise "Jack")
Niveau nominal	+4 / -20dBm (commutable)
Impédance	220Ω

MEMOIRE

Présélections (ROM)	1 ~ 40
Mémoire de l'utilisateur (RAM)	41 ~ 99

COMMANDE MIDI

Changement de programme ("PROGRAM CHANGE") - Sélection des mémoires
 Note activée ("NOTE ON") - Sélection de la touche de base MIDI,
 Déclenchement (Trigger)
 Changement de commande ("CONTROL CHANGE")
 Vidage et chargement de bloc (BULK DUMP & LOAD) - Vidage de paramètres

PANNEAU AVANT

Commandes
TOUCHES

Niveau d'entrée
 Incrémentation/décrémentation de paramètres, Paramètre, Défilement arrière (SCROLL BACK), Egalisation, Niveau, Paramètres internes, Assignation de commande externe, Mémorisation (STORE), Incrémentation/décrémentation de mémoire, Rappel (RECALL), Utilitaire, Déclenchement (TRIGGER), Con tournement (BYPASS)

Affichage

16 caractères × 2 lignes (Affichage à cristaux liquides)
 DEL de 2 chiffres à 7 segments (No de mémoire)
 2 × 8 segments DEL (indicateur de niveau)

Connecteurs

Commande externe (EXT CTRL), prise de commande de volume au pied (FOOT VOL) × 2

PANNEAU ARRIERE

Connecteurs

Entrée (Prise "jack" × 2)
 Sortie (Prise "jack" × 2)
 MIDI IN, THRU/OUT (Din 5 broches × 2)
 Entrée/sortie numériques (Prise DIP 8 broches × 2)
 TRIGGER 1 SW (Prise "jack")
 TRIGGER 2 SW (analogique) (Prise "jack")
 MEMORY IN/DEC (Prise "jack")
 Commutateurs
 Niveau d'entrée, Niveau de sortie
 MIDI THRU/OUT
 Niveau du déclencheur 2 (analogique)

Caractéristiques générales

Alimentation

US et Canada: 120V, 60Hz, 22W
 Modèle général: 220-240V, 50/60Hz, 22W
 Dimensions:
 480 × 45,2 × 319 (mm)

Dimensions:

• 0dB = 0,775V r.m.s.
 • Caractéristiques et présentation susceptibles d'être modifiées sans préavis

TECHNISCHE DATEN

ELEKTRISCHE WERTE

Frequenzgang	20Hz ~ 20kHz
Dynamikbereich~	90dB
Klirrfaktor	0,03% (@ 1kHz)

EINGÄNGE

Anzahl Kanäle	Unsymmetrisch×2 (Klinken)
Nennpegel	+4/-20dBm, UMSCHALTBAR
Impedanz	50kΩ (STERE)-IN), 25kΩ. (MONO)
Input-Regler	Rotierend-Rontinvierlich

A/D-UMWANDLUNG

Anzahl Kanäle	2 (A/D Wandler × 1)
Abtastrate	44,1kHz (außer D-IN)
Quantisierung	16Bit

D/A-UMWANDLUNG

Anzahl Kanäle	2
Abtastrate	44,1kHz (außer D-IN)
Quantisierung	16Bit

AUSGÄNGE

Anzahl Kanäle	Unsymmetrisch × 2 (Klinken)
Nennpegel~	+4 / -20dBm UMSCHALTBAR
Last	220Ω

SPEICHER

PRESET	1 ~ 40 (ROM)
USER	41 ~ 99 (RAM)

MIDI

Programmwechsel (Speicheranwahl)
Note-An (BASE KEY-Bestimmung), Trigger
Steuerelementänderung
Blockabwurf & empfang (Parameterübertragung)

FRONTPLATTE

Regler	Eingangspiegel
Tasten	EQ, PARAM, SCROLL BACK, PARAMETER EVEL/DELAY, STORE, MEMORY INC/DEC, RECALL, ONT. PARAM, TRIGGER, UTILITY, BYPASS
DISPLAY	16 Zeichen × 2 Zeilen (Flüssigkristall), 2 Ziffern (Leuchtdioden), 8 gliedrige
LED-Kette	
ANSCHLÜSSE	FOOT VR JACK × 2

RÜCKSEITE

ANSCHLÜSSE	INPUT (Klinke × 2) OUTPUT (Klinke × 2) MIDI IN, MIDI THRU/OUT (DIN × 2) DIGITAL I/O (DIP 8P × 2) TRIGGER1 SW (Klinke) TRIGGER2 SW ANALOG (Klinke) MEMORY INC/DEC (Klinke) BYPASS (Klinke)
SCHALTER	INPUT LEVEL, OUTPUT LEVEL MIDI THRU/OUT SW TRIGGER2 ANALOG LEVEL

ALLGEMEINES

Stromanforderungen	USA & Kanada: 120V, 60Hz, 22W Allgemeines Modell: 220-240V, 50/60Hz, 22W
ABMESSUNGEN	480 × 45,2 × 319 mm

- 0dB= 0,775 V r.m.s.
- Änderungen der technischen Daten ohne vorherige Ankündigung vorbehalten.

DIO Mode

① Analog

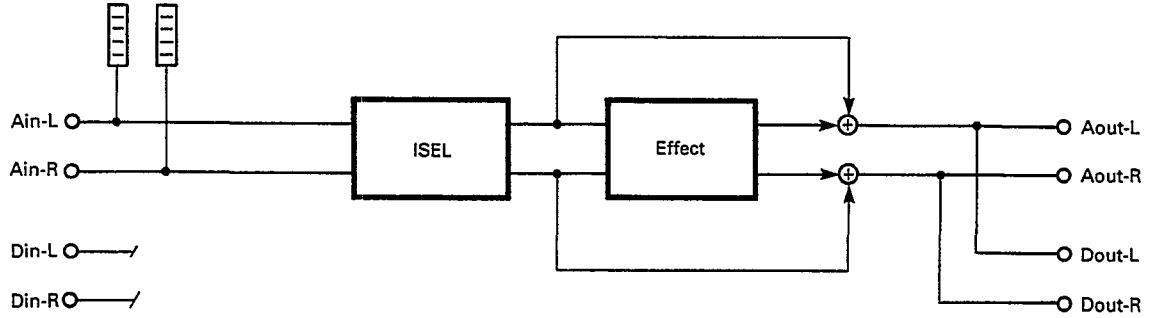

② Pre

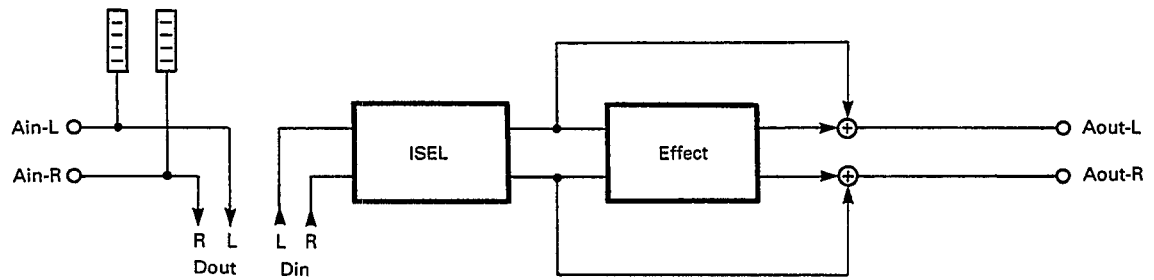

③ Post

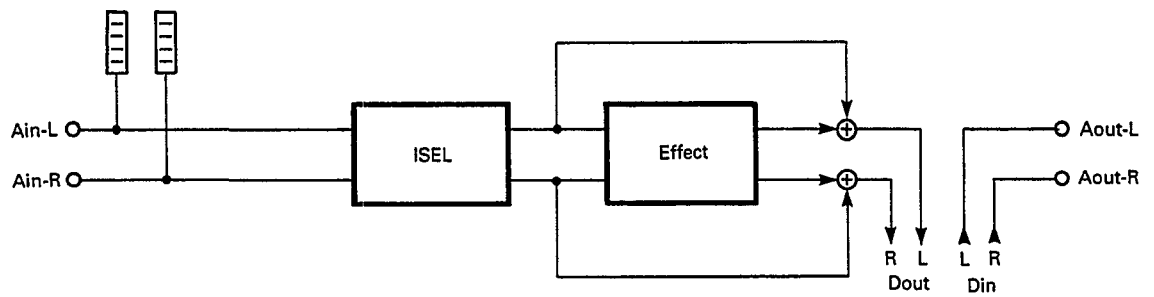

④ Digital

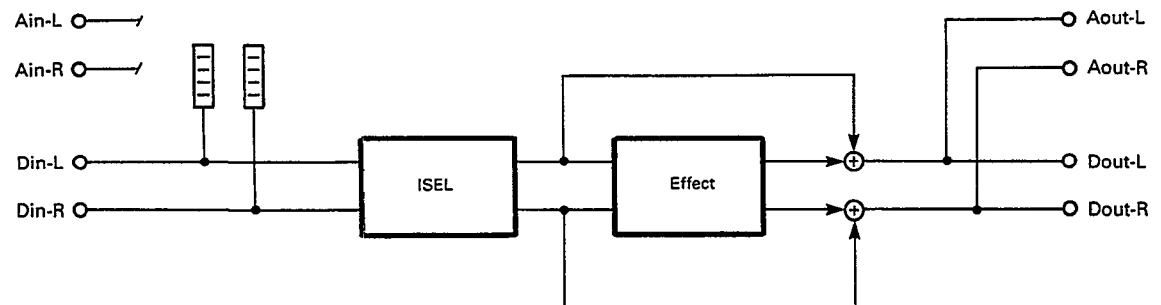

Input Mode

① Stereo Normal

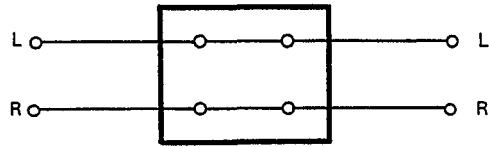

② Stereo Reverse

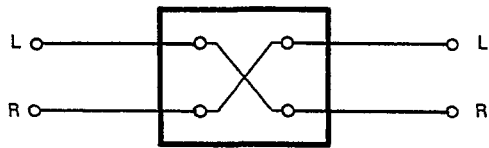

③ Mono L

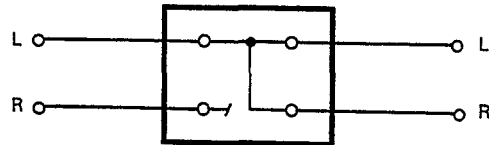

④ Mono R

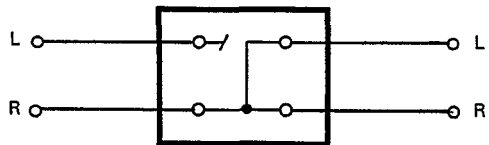

Effect Mode

① Single No.1~27

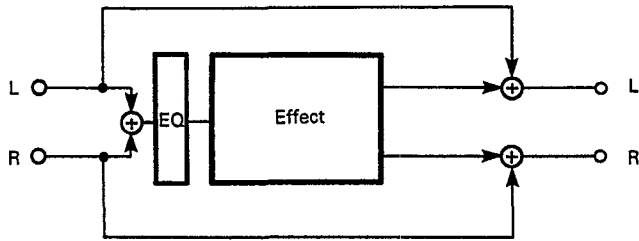

② Multi No.28~30

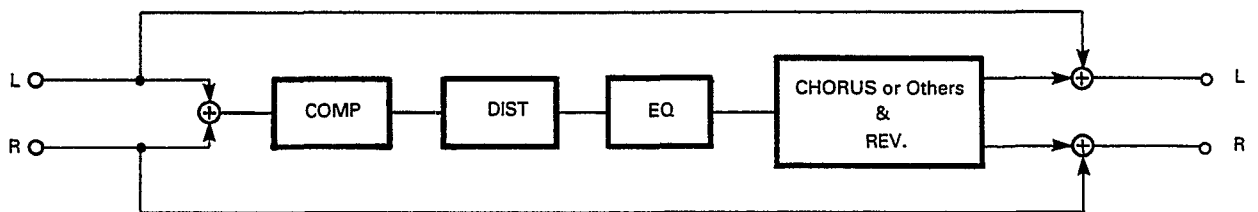

③ 2ch In No.31~35

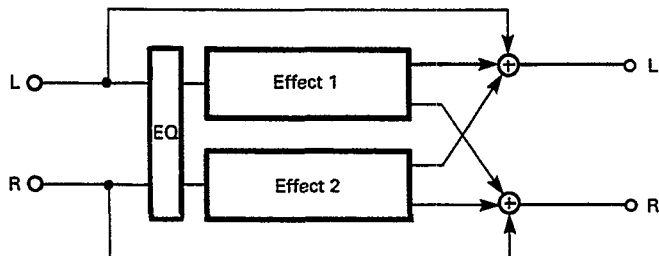

④ Stereo No.36~40

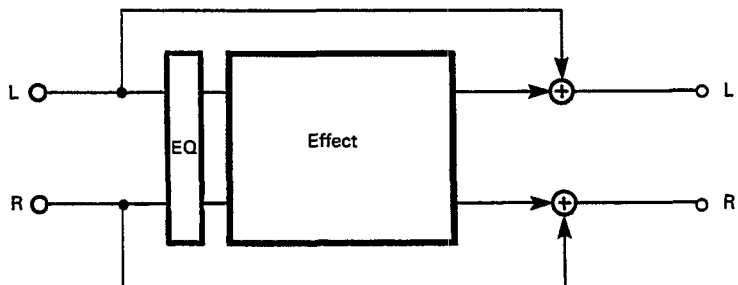

SPX1000 USER PROGRAMMING TABLE

Date: _____

Programmer: _____

Memory No.	Program Title	Memory No.	Program Title	Memory No.	Program Title
1	REV 1 HALL	34	CHORUS+REV	67	
2	REV 2 ROOM	35	PAN + PAN	68	
3	REV3 VOCAL	36	COMPRESSOR	69	
4	REV 4 PLATE	37	LO LVL EXPANDER	70	
5	REV 5 ECHO ROOM	38	EXCITER	71	
6	EARLY REF. 1	39	STEREO PITCH	72	
7	EARLY REF. 2	40	STEREO FREEZE	73	
8	EARLY REF. 3	41		74	
9	GATE REVERB	42		75	
10	REVERSE GATE	43		76	
11	DELAY L, C, R	44		77	
12	STEREO ECHO	45		78	
13	STEREO FLANGE A	46		79	
14	STEREO FLANGE B	47		80	
15	CHORUS	48		81	
16	STEREO PHASING	49		82	
17	TREMOLO	50		83	
18	SYMPHONIC	51		84	
19	ADR-NOISE GATE	52		85	
20	PITCH CHANGE-1	53		86	
21	PITCH CHANGE-2	54		87	
22	PITCH CHANGE-3	55		88	
23	FREEZE 1	56		89	
24	FREEZE 2	57		90	
25	PAN	58		91	
26	TRIGGERED PAN	59		92	
27	DISTORTION	60		93	
28	MULTI (CHO & REV)	61		94	
29	MULTI (SYM + REV)	62		95	
30	MULTI (EXC & REV)	63		96	
31	PLATE + HALL	64		97	
32	ER + REV	65		98	
33	ECHO + REV	66		99	

SPX1000 USER PROGRAMMING TABLE

Memory No.: _____ Date: _____

Program Title: _____ Programmer: _____

Function Key	Parameter										
	1	2	3	4	5	6	7	8	9	10	11
[PAPM]	12	13	14	15	16	17	18	19	20	21	22
[NT PAPM]											
[EO]											
[LEVEL]											
[EXT CLR, JSS CLR]											

SPX1000

MIDI PROGRAM CHANGE NUMBER VS MEMORY (PROGRAM) NUMBER

BANK: _____

ch= _____

Date: _____

Programmer: _____

PGM 1	MEM	PGM 44	MEM	PGM 87	MEM
PGM 2	MEM	PGM 45	MEM	PGM 88	MEM
PGM 3	MEM	PGM 46	MEM	PGM 89	MEM
PGM 4	MEM	PGM 47	MEM	PGM 90	MEM
PGM 5	MEM	PGM 48	MEM	PGM 91	MEM
PGM 6	MEM	PGM 49	MEM	PGM 92	MEM
PGM 7	MEM	PGM 50	MEM	PGM 93	MEM
PGM 8	MEM	PGM 51	MEM	PGM 94	MEM
PGM 9	MEM	PGM 52	MEM	PGM 95	MEM
PGM 10	MEM	PGM 53	MEM	PGM 96	MEM
PGM 11	MEM	PGM 54	MEM	PGM 97	MEM
PGM 12	MEM	PGM 55	MEM	PGM 98	MEM
PGM 13	MEM	PGM 56	MEM	PGM 99	MEM
PGM 14	MEM	PGM 57	MEM	PGM 100	MEM
PGM 15	MEM	PGM 58	MEM	PGM 101	MEM
PGM 16	MEM	PGM 59	MEM	PGM 102	MEM
PGM 17	MEM	PGM 60	MEM	PGM 103	MEM
PGM 18	MEM	PGM 61	MEM	PGM 104	MEM
PGM 19	MEM	PGM 62	MEM	PGM 105	MEM
PGM 20	MEM	PGM 63	MEM	PGM 106	MEM
PGM 21	MEM	PGM 64	MEM	PGM 107	MEM
PGM 22	MEM	PGM 65	MEM	PGM 108	MEM
PGM 23	MEM	PGM 66	MEM	PGM 109	MEM
PGM 24	MEM	PGM 67	MEM	PGM 110	MEM
PGM 25	MEM	PGM 68	MEM	PGM 111	MEM
PGM 26	MEM	PGM 69	MEM	PGM 112	MEM
PGM 27	MEM	PGM 70	MEM	PGM 113	MEM
PGM 28	MEM	PGM 71	MEM	PGM 114	MEM
PGM 29	MEM	PGM 72	MEM	PGM 115	MEM
PGM 30	MEM	PGM 73	MEM	PGM 116	MEM
PGM 31	MEM	PGM 74	MEM	PGM 117	MEM
PGM 32	MEM	PGM 75	MEM	PGM 118	MEM
PGM 33	MEM	PGM 76	MEM	PGM 119	MEM
PGM 34	MEM	PGM 77	MEM	PGM 120	MEM
PGM 35	MEM	PGM 78	MEM	PGM 121	MEM
PGM 36	MEM	PGM 79	MEM	PGM 122	MEM
PGM 37	MEM	PGM 80	MEM	PGM 123	MEM
PGM 38	MEM	PGM 81	MEM	PGM 124	MEM
PGM 39	MEM	PGM 82	MEM	PGM 125	MEM
PGM 40	MEM	PGM 83	MEM	PGM 126	MEM
PGM 41	MEM	PGM 84	MEM	PGM 127	MEM
PGM 42	MEM	PGM 85	MEM	PGM 128	MEM
PGM 43	MEM	PGM 86	MEM		

Litiumbatteri!

Bör endast bytas av servicepersonal.
Explosionsfara vid felaktig hantering.

VAROITUS!

Lithiumparisto. Räjähdyksvaara.
Pariston saa vaihtaa ainoastaan alan
ammattimies.

ADVARSEL!

Lithiumbatteri!
Eksplosionsfare. Udsiftning må kun foretages
af en sagkyndig, — og som beskrevet i
servicemanualen.

YAMAHA

YAMAHA[®]

Yamaha Corporation of America
6600 Orangethorpe Avenue, P.O. Box 6600, Buena Park, CA 90622-6600

1/24/97 24955



Recyclable



Recycled