

TECHNICAL SERVICE MANUAL for



**MICROMOOG
MODEL 2090**



**MULTIMOOG
MODEL 326A**

TECHNICAL SERVICE MANUAL

for
MICROMOOG
and
MULTIMOOG
synthesizers

MICROMOOG
MODEL 2090



MULTIMOOG
MODEL 326A

James L. Scott - BSEE
(Author)
MOOG MUSIC INC.
2500 Walden Avenue
Buffalo, New York 14225

Copyright - October, 1979

CONTENTS

SECTION		PAGE NO.
	Title Page / Frontispiece	iii
	Contents	iv
	List of Illustrations	vi
	List of Tables	vi
1	INTRODUCTION	1-1
	1.1 ORGANIZATION OF THE MANUAL	1-1
	1.2 GENERAL SYSTEM DESCRIPTION	1-1
	1.3 MODEL MODIFICATIONS	1-1
2	CIRCUIT DESCRIPTION	2-1
	2.1 POWER SUPPLY	2-1
	2.2 KEYBOARD CIRCUIT	2-2
	2.2.1 DC Operation (Control Voltage Generation)	2-2
	2.2.2 AC Operation (Trigger Generation)	2-3
	2.3 CONTROL VOLTAGE SUMMERS AND DUAL EXPONENTIAL CURRENT SOURCE	2-5
	2.3.1 Oscillator Control Summing	2-5
	2.3.2 Filter Control Summing	2-7
	2.3.3 Dual Exponential Current Source	2-7
	2.4 OSCILLATOR, WAVESHAPER AND DOUBLER	2-8
	2.4.1 Oscillator	2-8
	2.4.2 Waveshaper	2-9
	2.4.3 Doubler	2-9
	2.5 VOLTAGE CONTROLLED LOWPASS FILTER	2-11
	2.6 VOLTAGE CONTROLLED AMPLIFIER	2-13
	2.7 DUAL CONTOUR GENERATOR	2-15
	2.8 MODULATION	2-16
	2.9 NOISE SOURCE SAMPLE AND HOLD	2-17
	2.9.1 Noise Source	2-17
	2.9.2 Sample and Hold	2-17
	2.10 MISCELLANEOUS OFF-BOARD COMPONENTS	2-17
	Top Board 2	6-6
	Tandem Board 3	6-6
3	DISASSEMBLY PROCEDURES	3-1
	3.1 OPENING THE SYNTHESIZER	3-1
	3.2 KEYBOARD REMOVAL	3-5
	3.3 MAIN PC BOARD REMOVAL	3-5
	3.4 LEFT HAND CONTROLLER (LHC)	3-10
4	TUNING AND ADJUSTMENT PROCEDURES	4-1
	4.1 EXTERNAL AND INTERNAL ADJUSTMENTS	4-1
	4.2 EXTERNALLY ACCESSIBLE ADJUSTMENTS	4-1
	4.2.1 Oscillator Tuning	4-1
	4.2.1.1 Oscillator Range	4-2
	4.2.1.2 Oscillator Scale	4-2
	4.2.1.3 Oscillator High Frequency Compensation	4-2
	4.2.1.4 Oscillator Octave Step	4-2

CONTENTS (Continued)

SECTION		PAGE NO.
4	4.3 FILTER TUNING.....	4-3
	4.3.1 Emphasis.....	4-3
	4.3.2 Filter Scale.....	4-3
	4.3.3 Filter High Frequency Compensation.....	4-4
	4.3.4 Filter Octave Step.....	4-4
	4.4 OTHER ADJUSTMENTS.....	4-4
	4.4.1 VCA Balance.....	4-4
	4.4.2 Trill Trim.....	4-4
	4.4.3 Ribbon Centering.....	4-5
	4.5 INTERNALLY ACCESSIBLE ADJUSTMENTS.....	4-5
	4.5.1 - 15V ADJ.....	4-5
	4.5.2 Current Source Chip Temperature.....	4-5
	4.5.3 Filter Balance.....	4-6
	4.5.4 Filter Range.....	4-6
	4.6 MULTIMOOG OSCILLATOR TUNING PROCEDURE.....	4-6
	4.6.1 Oscillator "A" Temperature Adjustment.....	4-6
	4.6.2 Oscillator "A" Tuning.....	4-6
	4.6.3 Interval Tuning Adjustment.....	4-6
5	TROUBLESHOOTING GUIDE.....	5-1
	5.1 SOUND CHAIN.....	5-1
	5.2 PITCH DRIFT AND TUNING.....	5-4
	5.2.1 Oscillator Drift.....	5-4
	5.2.2 Oscillator and Filter.....	5-4
	5.3 KEYBOARD.....	5-5
	5.3.1 Cleaning Key Contacts.....	5-5
6	REPLACEMENT PARTS LIST.....	6-1
	NOTE: This section also contains Multimoog circuit description and schematic diagrams	

LIST OF ILLUSTRATIONS

FIGURE		PAGE NO.
1-1	Rear Panel, Early Version	1-2
1-2	Rear Panel, Latest Version	1-2
1-3	Control Panel, Early Version	1-2
1-4	Control Panel, Latest Version	1-2
2-1	Simplified Regulator Schematic	2-1
2-2	Keyboard Control Voltage Generation	2-3
2-3	AC Equivalent of Keyboard String	2-4
2-4	Equivalent AC Amp O/P Circuit	2-4
2-5	Simplified Oscillator Circuit	2-8
2-6	Waveshaper Output Shape Versus Waveshape Control Voltage	2-10
2-7	VCF Frequency Response Curves for Zero and Full Emphasis	2-11
2-8	Equivalent Filter Ladder Circuit	2-12
2-9	Envelope Shape (Either Section) at Timing Capacitor C705 or C706	2-14
2-10	Loudness Limiting	2-15
3-1	Removing Case from Base	3-1
3-2	Unplugging Audio Output Connector	3-2
3-3	Unlocking Cable Clamp	3-2
3-4	Base Assembly	3-3
3-5	Installation of Grommet Strip	3-3
3-6	Removing Ivories	3-4
3-7	Levelling Key	3-4
3-8	Keyboard Mounting	3-5
3-9	Servicing Switch Contacts	3-6
3-10	Keyspring Replacement	3-6
3-11	Knob Removal	3-7
3-12	PC Board Removal	3-7
3-13	PC Board In Service Position	3-8
3-14	Left Hand Controller Removal	3-8
3-15	Left Hand Controller Assembly, Part No. 93-603	3-9
4-1	Position for Making Externally Accessible Adjustments	4-1
4-2	Oscillator Tuning Sound Chart	4-2
4-3	Filter Tuning Sound Chart	4-3
4-4	VCA Balance & Trill Trim Sound Chart	4-4
5-1	Sound Chain Check	5-1
6-1	Micromoog Block Diagram	6-3
6-2	Micromoog Interconnect Harness Assembly	6-5
6-3	Micromoog Schematic Diagram	6-7

LIST OF TABLES

TABLE		PAGE NO.
5-1	Sound Chain Troubleshooting Guide	5-1
5-2	Oscillator and Filter Troubleshooting Guide	5-4
5-3	Keyboard Troubleshooting Guide	5-6
5-4	Pots and Switches Troubleshooting Guide	5-7
5-5	Control Circuits Troubleshooting Guide	5-8
5-6	Power Supply Troubleshooting Guide	5-9
5-7	Noise, Etc. Troubleshooting Guide	5-10

SECTION 1

INTRODUCTION

This manual provides servicing and parts information for the Micromoog/Multimoog Synthesizers.

1.1 ORGANIZATION OF THE MANUAL

The manual is divided into 6 sections. Section 1 provides general system description and model modifications; Section 2 describes the circuit. Section 3 gives step-by-step procedures for disassembly of the keyboard, main PC board and the left hand controller. Section 4 describes the tuning and the external and internal adjustment procedures. Section 5 contains the troubleshooting guide. To facilitate ordering replacement parts, see Section 6.

1.2 GENERAL SYSTEM DESCRIPTION

(See Block Diagram — Figure 6-1)

The Synthesizers consist of several circuit blocks. The POWER SUPPLY converts AC line voltage into precisely regulated ± 15 volts DC to operate all other Micromoog circuits. A single VOLTAGE CONTROLLED TONE OSCILLATOR (VCO) generates the audio frequency waveforms that serve as the source of pitched sounds. The waveshaped output of this oscillator passes through the VOLTAGE CONTROLLED LOWPASS FILTER (VCF) which strongly modifies the timbre of the oscillator tone. The NOISE SOURCE produces a pitchless hissing sound that also may be fed into the filter. The output of the VCF passes through the VOLTAGE CONTROLLED AMPLIFIER (VCA) to the instrument audio output. The gain of the VCA is dynamically shaped during a note by one section of the DUAL CONTOUR GENERATOR. The VCA and contour generator operating together constitute a loudness ARTICULATOR. The other section of the DUAL CONTOUR GENERATOR dynamically shapes the timbre of the VCF during a note. The contour generator action is initiated by a trigger generated within the KEYBOARD each time a key is depressed. The KEYBOARD also generates a control voltage that increases as successively higher keys are depressed. This control voltage establishes the VCO pitch and at the same time causes the VCF to track the VCO

to maintain constant timbre. The MODULATION OSCILLATOR generates subaudio waveforms used for control (not audio) purposes. This oscillator also triggers the SAMPLE AND HOLD which samples the noise circuit to yield control voltage that randomly changes levels at a tempo set by the RATE control. The source of modulation is set by the SOURCE switch and the circuit it will modulate is chosen by the ROUTING switch. The MODULATION AMOUNT wheel controls the level sent to the selected circuit. The Micromoog provides DC power to operate auxiliary equipment. Through the rear panel the Micromoog interfaces with external equipment such as auxiliary controllers, other synthesizers, modular equipment and other musical instruments.

1.3 MODEL MODIFICATIONS

This manual refers to the current production model as of July 1976 — Serial Number 3300 and above. Since the Micromoog was introduced to the music world, several major and numerous minor improvements have been incorporated. Some of the modifications are discussed and illustrated in the following:

1) As of July 1976, the keyboard was modified. It functions identically to and is interchangeable with earlier models. The discrete resistors and vertical PC Board have been replaced by resistor packs and a horizontal PC Board.

2) A direct audio output cable has been provided to eliminate a slight bleed thru. The cable is now available as a field retrofit kit.

3) A small rear panel PC Board and a control pot (R261) has been added to provide variable keyboard output control voltage. See Figures 1-1 and 1-2.

4) As of October 1975, the nomenclature on the main control panel, Serial Number 1500 and above, was revised with no functional changes. See Figures 1-3 and 1-4.



FIGURE 1-1 REAR PANEL, EARLY VERSION



FIGURE 1-2 REAR PANEL, LATEST VERSION



FIGURE 1-3 CONTROL PANEL, EARLY VERSION



FIGURE 1-4 CONTROL PANEL, LATEST VERSION

SECTION 2 CIRCUIT DESCRIPTION

2.1 POWER SUPPLY

The supply draws 150 mA from a 115 VAC 60 Hz input (or 75 mA from a 230 VAC 60 Hz input) when the + 15V and - 15V outputs are 200 mA each. C1 and C2 decouple RFI that may be riding in on the line. SW1 connects the primaries of T1 in parallel for 115V operation and in series for 230V operation. F1 and 2 are in parallel for 115 VAC operation (250 mA blowout point) and in series for 230 VAC operation (125 mA blowout point). The fuses protect against fire hazard should a short occur in the secondary of T1. They will not blow if the regulator outputs short out. (The regulator will current limit instead.) They will blow if 230 VAC is applied and SW1 is set for

115 VAC. IC101 has been observed to survive the 1/4 second overvoltage that occurs at its inputs in such an instance.

T1 steps the input AC down to 36 VAC center-tapped. The diode bridge CR101-CR104 rectifies the AC to roughly ± 25 VDC. At a normal full load of ± 150 mA (Micromoog with 1125 Sample and Hold plugged into back), C101 and C102 provide sufficient filtering to keep the raw DC ripple around 2Vp-p. Dual tracking regulator IC101 operates with external pass transistors Q101 and Q102. These transistors drop the raw DC voltages to ± 15 DC. C103 and C104 stabilize the regulator against high frequency oscillation.

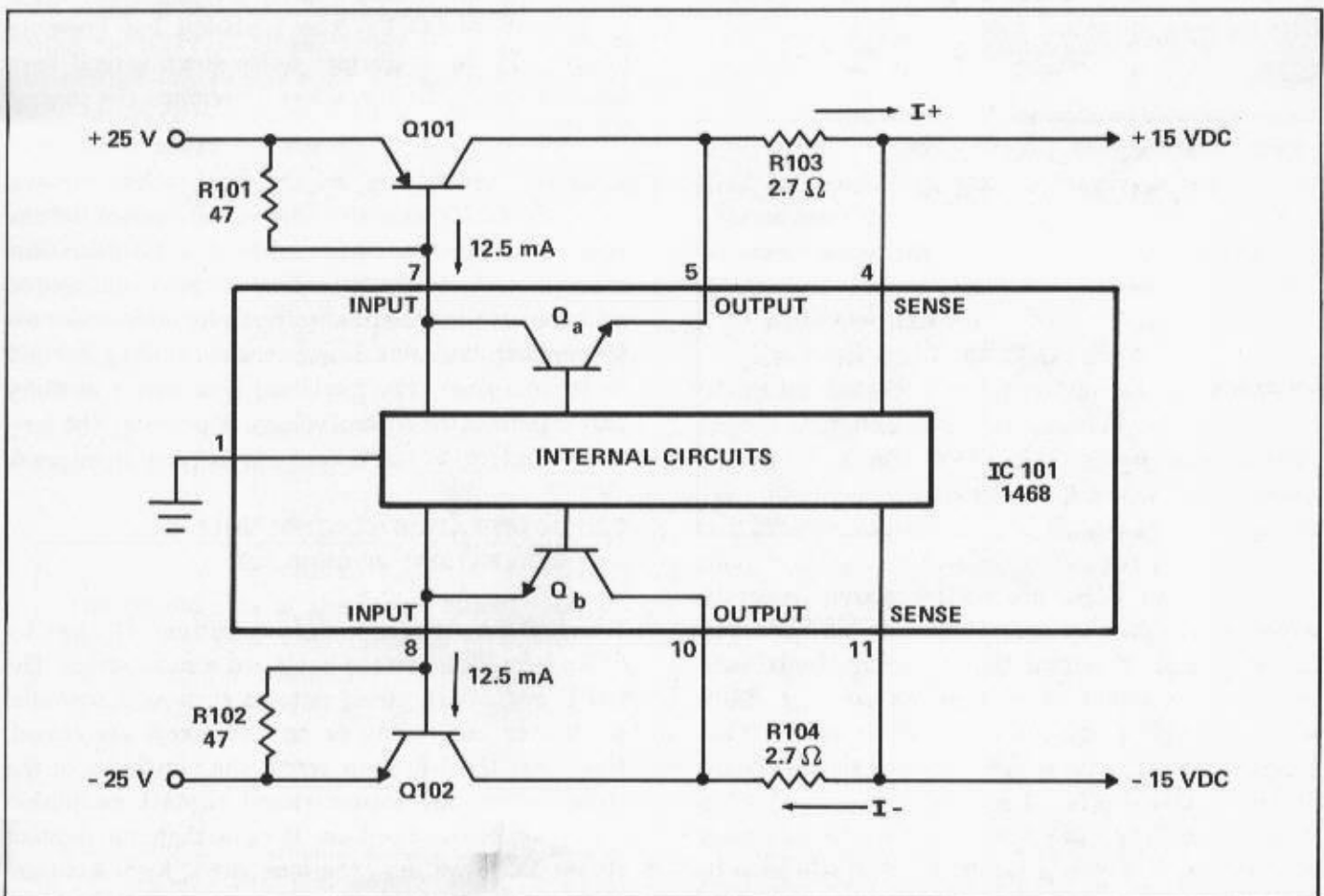

FIGURE 2-1 SIMPLIFIED REGULATOR SCHEMATIC

Since the base-emitter drop of external pass transistor Q101 is about 0.6V, R101 will feed about (0.6V/47 ohm = 12.5 mA) into IC101 pin 7, which is more than sufficient to supply the 5 mA required to operate internal chip circuitry. Qa passes the balance of this 12.5 mA. Q101 forms a PNP-NPN Darlington configuration with the internal pass transistor Qa. Q101 passes most of the positive current I+ and therefore dissipates most of the heat allowing IC101 to run cooler.

Pin 4 senses + 15 V and causes the internal circuits to drive Qa to maintain the output very precisely as the line and load vary. The sense input provides another service; if I+ reaches 250 mA, the drop across R103 will rise to 0.7V and the supply will go into the current limit mode. If the output is shorted to ground, Q101 will dissipate several times normal power. However, Q101 will not burn out no matter how long its output remains shorted due to the attached heat sink. The negative regulator works in exactly the same fashion as the positive regulator. Here are some important specs:

Input Voltage	± 30V Max.
Output Accuracy	± 10 mV (-15V trimmed) ± 300 mV (+15V untrimmed)
Long Term Output Drift	± 3 mV/1000 hours typical
Output Load Reg.	30 mV Max. (0 to 200 mA)
Output Line Reg.	20 mV Max. (90 VAC to 130 VAC 60Hz)
Output Noise	1.0 MV RMS Max. (100 Hz to 100 kHz B.W.)
Output Temp. Stab.	0.015%/°C Max.
Output Current Limit Value	250 mA

C105 and C104 are solid tantalum types to effectively filter high frequency noise. CR105 and CR106 protect the regulator against accidental connection to a supply of an opposite polarity. R106 sets the - 15V supply to - 15.00V. It must be set accurately since it is the reference for the Keyboard String, Octave Buffer, Oscillator Range and Chip Temperature. The + 15V supply need not be extremely accurate so no trim is provided for it. It still must be precise — i.e.: it must not drift or be noisy, especially since the - 15V supply tracks the + 15V supply.

C109 and C110 decouple the power supply lines on the main PC Board to forestall parasitic oscillations.

The 1468 regulator is a ceramic encapsulated device (non-hermetic glass frit type) rather than a plastic device. The use of a plastic package would result in a chip temperature of 125°C (not necessarily worst case). This is dangerously close to the maximum allowable chip temperature of 150°C. High temperatures cause shortened chip life, more rapid long-term drift, and greater thermal (warm-up) drift. With ceramic encapsulation the chip temperature is about 85°C — a much more comfortable figure.

2.2 KEYBOARD CIRCUIT

The KEYBOARD CIRCUIT produces a control voltage (to determine pitch) that increases linearly as successively higher keys are depressed. The control voltage increases from 0.00 volts at LO F (lowest key) at the rate of one volt per octave (83.3 mV/semitone) to a maximum of 2.58V at HI C (highest key 2-1/2 octaves above LO F). The keyboard has low-note priority. If the performer holds down several keys simultaneously, the lowest key determines the control voltage.

The GLIDE control allows adjustment of the control voltage transition rate from a 0.3 msec time constant (effectively instantaneous pitch change) to a 1.0 second time constant (effectively several seconds before the pitch catches up to the controlling key and stops changing). The keyboard possesses a memory that maintains the control voltage at precisely the level of the output at the instant the last key is released.

2.2.1 DC OPERATION (CONTROL VOLTAGE GENERATION) (FIGURE 2-2)

IC202A applies constant current IK (set to 833 µA by R238) to the keyboard resistor string. The LO F end of the string remains at ground potential no matter how many or how few keys are closed. Note that the I-R drop across the remainder of the string below the lowest closed contact establishes VOUT applied to the buss. If more than one contact closes, IK flows onto the buss at the highest closure and returns to the string at the lowest closure. The intervening resistors are simply shorted out.

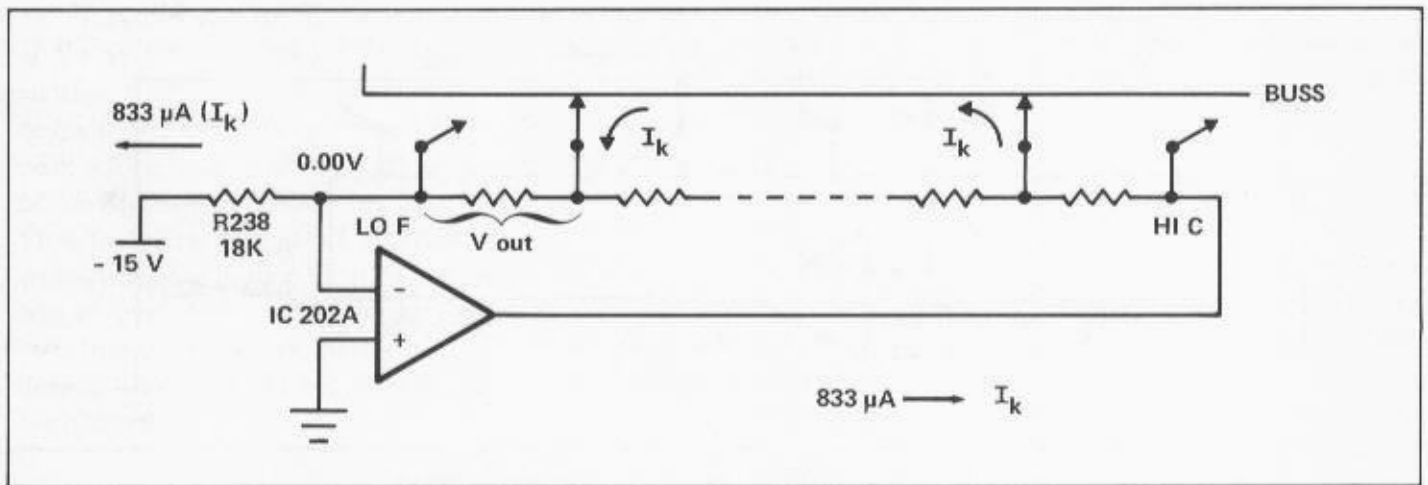

FIGURE 2-2 KEYBOARD CONTROL VOLTAGE GENERATION

When a key contact closes, holding capacitor C212 charges (or discharges) at the rate set by R251 to the level established on the buss. R250 sets a minimum charging time constant of $T_{CH}(\text{min}) = 0.22 \mu\text{F} \times 1.5\text{K} = 0.33 \text{ msec}$. R250 decouples the 25 kHz pilot oscillator signal (see below) from the DC control voltage on C212. R250 also filters key contact scrape and bounce that occurs when a lower contact closes while an upper contact is being held closed. When all keys are released, no further charging of C212 is possible and it holds the last instantaneous value of control voltage. Dual J-FET Q201 in conjunction with R252, R253 and IC204A comprise an extremely low input bias current unity gain buffer. The buffer provides substantial control voltage output drive capability while draining C212 at less than a 200 pA rate.

$$\text{MAXIMUM DISCHARGE RATE} = \frac{I}{C} = \frac{200 \text{ pA}}{.22 \mu\text{F}} \approx \frac{75 \text{ cents}}{\text{minute}}$$

NOTE

The output side of the buffer guards the input side. This vastly reduces on-board leakage since a potential equal to the value being held surrounds the entire holding circuit.

C213 and C214 decouple RFI pickup by the main PC Board. C214 also shunts capacitive audio pickup by the keyboard control voltage output line. CR203 and CR204 protect Q201 and IC204A from

static discharge coming in via J3. R257 does not affect the output level normally (it is inside the loop) but it does allow control voltage to be forced into J3 for testing purposes, or for introducing external control voltages to override the keyboard control.

2.2.2 AC OPERATION (TRIGGER GENERATION)

Since the keyboard uses a single-buss contact scheme, an AC pilot signal (generated by IC201) must be injected onto the buss so that detection of contact opening and closing can occur. When closure occurs, IC203 and IC202B amplify and detect the signal and develop a clean DC trigger output.

Oscillator IC201 generates the $25 \text{ kHz} \pm 5 \text{ kHz}$ triangular AC signal. 25 kHz lies above the audio range which reduces the chance that unwanted signal pickup by other Micromoog circuitry will be audible. The 3080 transconductance amplifier was chosen as IC201 because it has very fast slew rate, does not delay coming out of input or output saturation and does not draw current slugs from the supply lines while slewing or while saturated. The output of a 3080 is a bilateral current source the magnitude of which is given by:

$$I_{OUT} = \frac{0.02 \mu\text{A/mv (input)}}{\mu\text{A (Bias)}} ; I_{OUT}(\text{Max.}) = I_{BIAS}$$

R235 sets IBIAS (into pin 5) to 0.5 ma which keeps the total package dissipation at 30 mW, well below the absolute maximum of 125 mW. IOUT will tend to alternate between + 0.5 mA and - 0.5 mA,

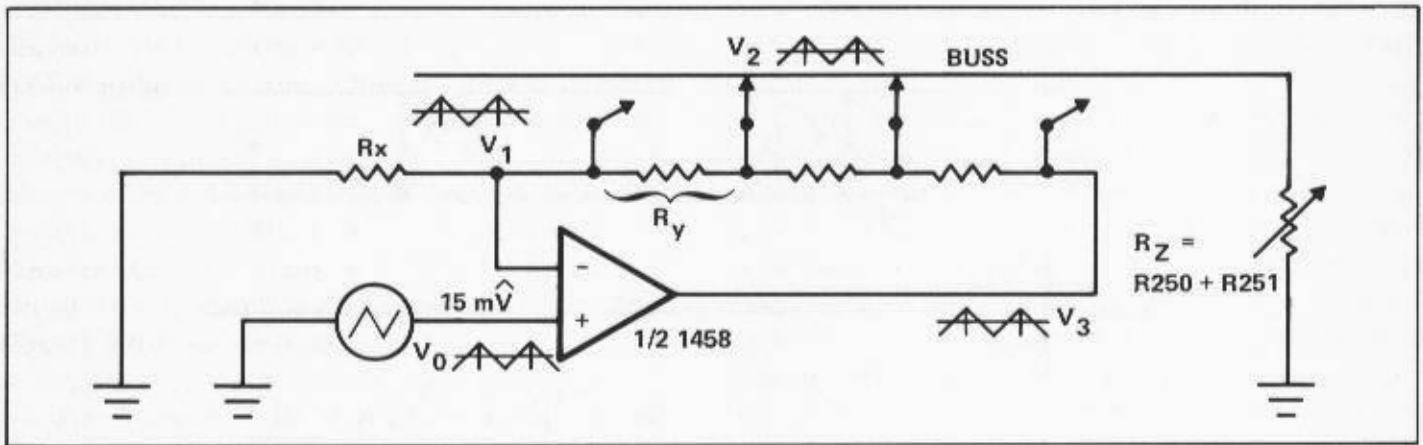

FIGURE 2-3 AC EQUIVALENT OF KEYBOARD STRING

however the 50K impedance presented by R233/R234 will cause the squarewave output at pin 6 to saturate at + 14 volts and - 14 volts instead. R234 and C201 integrate the squarewave into a triangular wave. R232 and R233 set the triangular output swing to ± 1.25 volts. C204, R236 and R237 couple this signal at a level of 15 mV peak (= 30 mV peak-to-peak) to the non-inverting input of IC202A. C202 and C203 are the bypass capacitors (required for every 3080 amp) to keep IC201 from breaking into high frequency oscillation.

Feedback via the keyboard resistor string forces V_1 to equal V_0 . V_2 supplied to the buss is:

$$V_2 = V_1 \frac{(R_x + R_y)}{R_x} \Rightarrow 15 \text{ m}\hat{V} \leq V_2 \leq 19 \text{ m}\hat{V}$$

This holds regardless of the number of keys depressed or the setting of RZ.

R239 decouples IC202A from the keyboard buss capacitance when HI C closes to prevent IC202A from oscillating.

It has been found that R239 does not completely solve the marginal AC stability of IC202A. The output of IC202A rings severely. Accordingly C215 has been added to bypass the equivalent R, L, C impedance in the feedback loop presented by the keyboard and its interconnecting cables.

Whenever one or more key contacts close, the AC signal injected onto the buss couples via C206 and R240 to the input of IC203. The signal at the input will exceed 6 mV peak even considering the loading by R241, R242 and amplifier Z_{IN} (worst case = 10K). With IC203, another useful property of the 3080 is exploited - the ability to provide very high gain at ultrasonic frequencies.

$$I_{OUT} (\text{min. AC peak}) = \frac{6.7 \mu\text{A}}{\text{mV}} \times 6 \text{ m}\hat{V} = 40 \mu\hat{A}$$

Typically, I_{OUT} will be 100 μA peak to yield the above equivalent output circuit (neglecting CR206 for the moment).

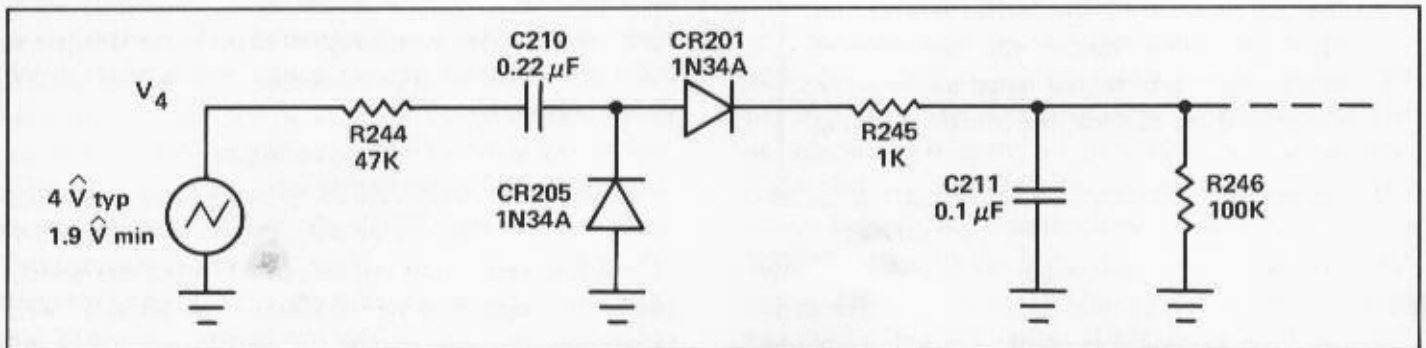

FIGURE 2-4 EQUIVALENT AC AMP O/P CIRCUIT

R244, R245 and R246 attenuate the peak value of V4 by a factor of 0.7, C210 and C211 attenuate it another 0.7V, and the germanium rectifier CR201 drops it 300 mV. This yields a V5 of at least 700 mV peak which easily overcomes the + 200 mV threshold of comparator IC202B set by R248 and R249. Therefore, the output of IC202B snaps from - 14 volts (trigger off) to + 14 volts (trigger on). When the trigger goes high, R247 feeds 1 μ A DC to R246 (whereas previously it drained 1 μ a). This current dropped across R246 provides 200 mV of hysteresis for IC202B.

When a key closes C211 charges quickly through CR201 (1 msec or less) but discharges slowly (10 msec) through R246. These time constants in conjunction with the hysteresis given by positive feedback resistor R247 provide excellent filtering of contact bounce and scrape.

The circuit completely eliminates any bounce with a period up to 10 msec. In addition, the 1 msec charge up time rejects fast noise spikes. That is, R245 assists in rejecting noise spikes whenever IC203 momentarily drives into saturation and sources 500 μ A (i.e., when Figure 2-4 equivalent circuit is no longer valid).

R241 and R242 provide input bias current to IC203. At worst the DC input voltage due to VOS and IOS will fall below 11 mV. R244 sets the output DC level nominally to ground, however due to input offsets the actual level may range from + 8 VDC to - 8 VDC. C210 blocks this unwanted DC level. C207 in conjunction with R244 rolls off the output of IC203 at 100 kHz to suppress oscillation. A11 3080 amps operated in the linear modes must have a similar capacitor.

When the performer releases all keys the AC trigger signal ceases and the voltage at pin 5 of IC 202B decays toward effectively + 100 mV (due to hysteresis) until it crosses the + 200 mV threshold. At that point, the output of IC202B switches back to - 14 volts and pin 5 proceeds back to its rest value of - 100 mV.

As long as oscillator bleed through to the buss stays below 1 mV peak, the AC output of IC203

will not be sufficient to misfire IC202B. At 20 kHz, C212 has $X_C = 1 / (2 \pi fC) = 40$ ohm. This attenuates the trigger signal sneaking into the control voltage output to at worst:

$$19 \text{ m}\hat{V} \times \frac{40 \Omega}{1500 \Omega} \approx 1/2 \text{ m}\hat{V}$$

IC204 receives the external S-trigger input. R255 and R256 set the input threshold to + 2 volts. CR202 forms a logic OR function with CR207. C213 and R254 debounce the external trigger. As long as the external open-contact "on" time is less than 15 msec, this circuit will be effective.

CR206 limits the input swing of IC202B to + 700 mV. If it were absent, whenever the output of IC203 went high, C211 could charge to about + 6V. About 5 time constants (50 msec) would be required for the input of IC202B to decay to the turn-off threshold after release of the external trigger. The resultant 50 msec dead time between notes is unacceptable for keyboard performance. A player could play faster than the Micromoog could respond, causing missed notes. CR206 cuts the discharge time to roughly 1 or 2 time constants (10 to 20 msec) and thereby prevents missed notes.

Newer models (after S/N 3300) have a small auxiliary PC board at the rear above the power supply board. IC205 and the associated pot R261 provide an adjustable keyboard control voltage output of from 0.90 to 1.10 volts per octave. Note that only when the pot switch is in the "click" (fully CCW) position can the KBD CONTROL OUTPUT jack be used as an input. This arrangement allows a "master" Micromoog to control a "slave" Micromoog. The R261 for the master can be used as a scale tuner for the slave if the slave R261 is clicked off.

2.3 CONTROL VOLTAGE SUMMERS AND DUAL EXPONENTIAL CURRENT SOURCE

2.3.1 OSCILLATOR CONTROL SUMMING

The oscillator summer linearly adds the seven control voltages that influence oscillator frequency - OCTAVE switch, FREQUENCY knob, FINE TUNE knob, ribbon, modulation, EXTERNAL INPUT, and keyboard. The weighted sum, VO, feeds one input

of the dual exponential current source to produce an oscillator control, I_O , that doubles for each increase of 20 mV applied to the base of Q301. I_O in turn sets the frequency of the wide range precision linear relaxation oscillator. Each doubling of I_O causes a one octave pitch rise. The overall effect yields a one octave pitch increase for each volt increase of the keyboard control voltage output.

IC301A and IC301B comprise an accurate non-inverting summing amp, the output of which rises 20 mV for each 10 μ A fed into the summing node. IC301A and IC301B operate at unity gain with respect to the keyboard control voltage. R348 and R349 attenuate the final output to a low level. This minimizes the effects of RFI pickup and op-amp noise and drift. R348 and R349 also prevent IC301B from applying damaging voltages to IC304 during instrument power-up.

Q307 and Q308 function as back-to-back zener diodes. Their leakage of .1 μ A (max.) is far superior to "real" zener diodes. They prevent IC301A from saturating in response to extreme input drive into the node by limiting the output summing of IC301A to roughly \pm 8V. If IC301A did saturate, the oscillator control sum node (at pin 2) would deviate from being a virtual ground. This would cause oscillator control inputs to couple via R330 and R314 or via R372, R373 and R374 into the filter control summing node (IC302A). The end result would be a mysterious shift in filter frequency. Q309 and Q310 similarly prevent the filter node from influencing oscillator pitch.

It is possible for the output of IC301B to rise to + 8V (8 octaves above $I_O = 14 \mu$ A - See Dual Exponential Current Source description that follows). That is, I_O could rise to 3.2 mA. This current is apt to overload current regulator IC303A if Q304 and Q305 are also conducting heavily. Accordingly R326 has been included in the output circuit of IC301B to limit the voltage applied to R348 to about + 5V. This limits I_O to roughly 400 μ A (40 kHz). CR303 is included so as not to limit the negative swing applied to R348 and thereby limit the lowest oscillator frequency obtainable.

OCTAVE switch SW301, divider chain R304, R306, R307 and R309 and summing resistor R330

subtract 10 μ A current increments from the oscillator control node to shift the oscillator pitch down in one octave increments. R303, R305, R308 and R310 keep the divider chain output impedance constant to prevent step inaccuracy due to loading. R329 trims the step size. Since filter octave switching derives from the same divider, the trim adjustments R329 and R311 will interact a little but not seriously. FREQUENCY control R301 acts only when SW301 is set to "wide". It sweeps the oscillator over a range of \pm 4 octaves by applying current to the node via R302.

When ROUTING switch SW802 rotates, the input voltage offset (V_{IO}) of IC301A will tend to cause slight but annoying shifts in pitch. Resistors R377 and R378 reduce this shift 90% by providing a relatively low impedance path to ground for the open contacts of SW802. Early models (S/N 1250 and lower, approximately) utilized an IC selected for low V_{IO} for IC301A ($V_{IO} \leq 1/2$ mV). Similarly R378 and R379 prevent filter pitch shifting. In earlier models IC302A also was selected for 1/2 mV V_{IO} .

SW302 disconnects the keyboard output from the oscillator in "drone" mode and it shorts out the audio output of the waveshaper in "off" mode. R335 and R336 set the oscillator frequency when all inputs = 0 volts to 700 Hz. This occurs when OCTAVE = 2' and keyboard LO F is depressed (2' LO F) with all other inputs off. R334 and R337 provide an adjustment range of \pm 4 semitones so "F" can be trimmed exactly to 698.5 Hz. Ribbon R1003 with R1004 and R339 sweep the oscillator over a range of \pm 8 semitones. R339 decouples the oscillator summing node from the cable harness. CR1001 and CR1002 provide a deadband at the center of the ribbon. R1001 and R1005 prevent the ribbon from shorting + 15V to - 15V in the case both ends of the ribbon are depressed simultaneously. The ribbon has no effect when not touched at all or when touched exactly in the center. R1002 adjusts the electrical center to exactly coincide with the mechanical center of the ribbon. R5 and R341 give a rear panel fine tune adjustment of \pm 2 semitones. The response to an external control voltage input (J3) is set to 13 semitones/volt by R343. R371 or R372 allows a nominal \pm 3 octaves frequency shift when the modulation amount is turned up fully (triangle modulation mode).

2.3.2 FILTER CONTROL SUMMING

IC302A and IC302B comprise a summer (just like the oscillator summer) that adds the seven control voltages that influence filter cutoff frequency — CUTOFF knob, OCTAVE switch, keyboard, external input, modulation, filter contour and FILT. MOD. BY OSC. switch. The filter control sum V_F feeds the other input of the current source to produce an exponential output control current I_F that sets the cutoff frequency of the lowpass filter. A 10 μ A increase in the amount fed into the filter control node causes V_F to increase 20 mV and therefore causes the cutoff to rise one octave (because I_F doubles).

Normally, the filter cutoff rises only 1/2 octave for each volt rise in keyboard output. The filter “half tracks” the oscillator to maintain constant timbre up and down the scale. However, when SW501 is set to “full” or “tone”, R324 parallels the normal summing resistor R316 causing the filter to fully track the oscillator. R321 adjusts the filter scale for exact one-to-one oscillator tracking.

Normally, OCTAVE switch SW301 moves the filter cutoff in 1/2 octave steps. In the “norm” mode a second section of SW501 shunts R312 to ground to maintain a constant load on the octave divider chain. In the “tone” or “full” mode, SW501 connects R312 and R314 in parallel to yield full octave steps. R311 adjusts the step size to exactly one octave. CUTOFF control R320 tunes the filter over a ± 5 octave range.

SW303 lets the tone oscillator “shake” the filter (rapidly vary its cutoff frequency) to produce useful timbral effects. R317 allows a “weak” shake of a little over an octave. R322 allows a “strong” shake of six octaves. The response to external control voltage input (J4) is 13 semitones/volt as set by R318. R380 and R381 provide a ± 1 octave range adjustment so that when all control inputs equal zero volts, the filter cutoff is 700 Hz = 2' LO F.

When modulation switch SW802 is set to “osc and filt”, the filter normally half-tracks the oscillator. However, if the performer sets SW501 to “tone” or “full”, R373 parallels R374 causing the filter to track the oscillator exactly. The “filt” position of SW802

allows a filter deviation of ± 6 octaves with the modulation wheel turned up fully (triangular modulation).

2.3.3 DUAL EXPONENTIAL CURRENT SOURCE

Q301, 302, 303, 304 and 305 are contained on a single IC chip mounted in a standard 14 lead plastic DIP. As I_O , I_F and I_F' vary, IC303A draws in current through CR301 to maintain the collector of Q302 exactly steady at $V_R = +750$ mV (± 250 mV depending on IC303A input bias current). This stabilizes the reference current I_R which flows through Q302 to 14 μ A. Oscillator current source Q301 balances against reference transistor Q302 to produce a highly precise current given by:

$$I_O = I_R e^{(V_O / V_T)}$$

where: $V_T \triangleq \frac{kT}{q}$

and: $\Delta V_T / \Delta T = +0.33\% / ^\circ\text{C}$

k = Boltzmann's constant

T = absolute Kelvin temperature

q = charge of one electron

R364 and R365 establish V_R at +750 mV. The primary purpose of this is to keep the input bias current of IC303A from dragging the collector of Q302 below ground potential, thereby spoiling its operation. CR301 prevents positive excursions of the output of IC303A from damaging IC304. R366 and C307 stabilize IC303A against oscillation by reducing its AC gain by 60dB above 1.5 kHz. C303 and C304 squelch parasitic oscillation and RFI pickup.

At the design chip temperature of 55 $^\circ$ C, V_O must change exactly 19.55 mV to cause I_O to double (or halve). This value of ΔV_O increases 0.0607 mV/ $^\circ$ C. In order to maintain the scale factor ΔV_O precisely constant, T (chip absolute temperature) must be carefully regulated. Now since a precision reference current I_R passes through Q302, V_E precisely measures temperature. $\Delta V_E / \Delta T$ is about -1.9 mV/ $^\circ$ C. Accordingly, we make Q302 serve two purposes; that of thermometer as well as reference device.

R358, R359 and R360 establish a temperature “set” potential V_S of approximately -0.55 volt. As the temperature of the chip decreases, the base-

emitter potential of Q302 increases. This results in V_E becoming more negative. If V_E drops below V_S , the output of IC303B goes negative. This output is applied via emitter follower Q306 to the bottom of R328. The potential at the top of R328 is fixed at + 1 volt by the emitter follower consisting of Q303 and bias resistors R367 and R368. Thus, the potential applied to the bottom of R328 sets the current that passes through the chip heater, Q303. Since the C-E potential is always about 14 volts, Q303 develops a maximum of 14 volts x 28 mA = 400 mW. As soon as the chip temperature rises enough so that $V_E = V_S$, the output of IC303B goes more positive to reduce the current drawn through Q303 and thereby maintain constant chip temperature.

Bias resistors R367 and R368 prevent the emitter of Q303 from going below the substrate potential (pin 13 is connected to the substrate). Also this biasing keeps the C-E potential below the absolute chip maximum of 15V. A potential of + 1V here also allows complete shut off of the heater thanks to the junction drops of Q306 and CR302. Q306 sinks more current than a 1458 op amp alone could provide. Also, use of Q306 avoids self heating of IC303B (and IC303A, since it is on the same chip). Such heating would upset VOS of both of these devices and contribute to IR and T errors. CR302 and R362 prevent breakdown of the base of Q306 should the output of IC303B rise above + 5 volts.

The chip-to-ambient thermal resistance Φ_{JA} of the current source was measured as 140°C/watt (RCA plastic CA3046 in DIP socket). This implies that the maximum temperature rise achievable is

about 55°C (140°C/watt x .4 watt) and therefore that the Micromoog will operate in ambients down to 0°C. In a 25°C ambient Q303 will dissipate 140 mW which implies that its current is 10 mA. Under normal conditions the chip temperature reaches 55°C in about 5 minutes. After this time a few more minutes are required for thermal gradients to settle out in the body and leads of the CA3046. Consequently, a total of about 10 minutes is required before the IO and IF scale factors to become rock-solid.

Filter current source transistor Q305 also balances against reference transistor Q302. Filter control current I_F is produced in exactly the same fashion as I_O . I_F' will be explained in Section 5.

2.4 OSCILLATOR, WAVESHAPER AND DOUBLER

2.4.1 OSCILLATOR

I_O steadily discharges C401 to produce a linearly declining ramp. The FET input amplifier consisting of Q402, R406, R407 and IC401B provides extremely low input current unity gain buffering of the capacitor ramp voltage. When the ramp reaches zero volts, the trigger circuit (R408, R409, R410, R411, R412, R413, C403, C404, C405, C406, C407, IC402, CR401) generates a 6 μ sec positive pulse that turns on switch Q401 momentarily. Q401 shorts out C401 causing the sawtooth wave to reset up to the + 10V reference (produced by R403, R404, R405, C402, C410, and IC401A). C401 is a polystyrene capacitor for good AC characteristics, good stability, and low leakage.

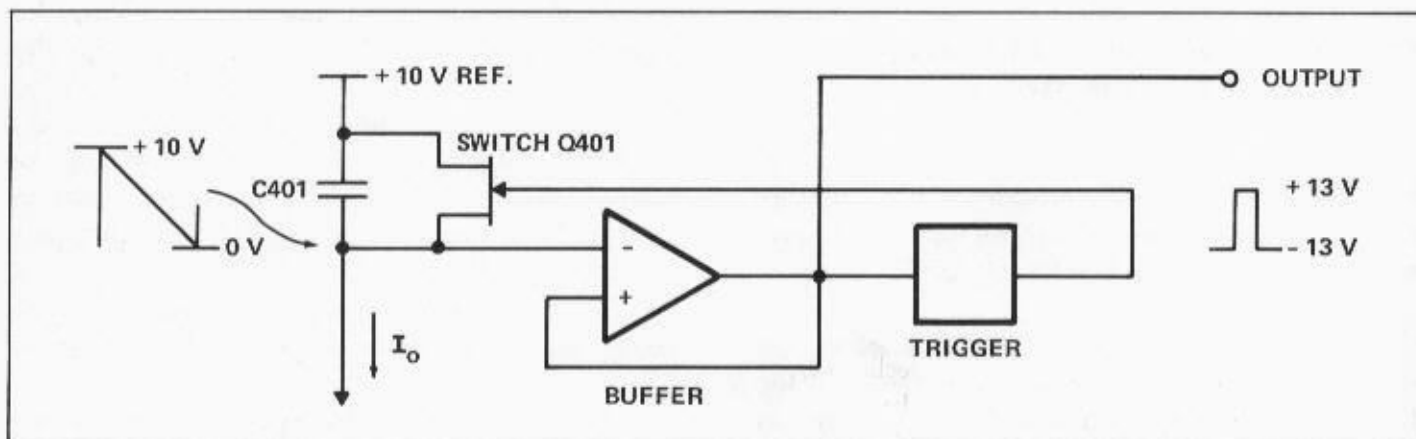

FIGURE 2-5 SIMPLIFIED OSCILLATOR CIRCUIT

R408 and R409 attenuate the sawtooth applied to IC402 so as not to exceed its differential input limit. R412 feeds a high value of amplifier bias current (1mA) to IC402 to maximize its speed. It would seem that this would put IC402 dissipation at 100 mW (dangerously close to the package limit of 125 mW). However, since the average output current is nearly zero, the dissipation is exactly halved to 50 mW.

The network consisting of C405, R410 and R411 feeds back a positive pulse (1.5 μ sec time constant) to the plus input of IC402. This precludes latchup of the reset loop. C406 stabilizes IC402 to prevent high frequency oscillation. In addition it limits the output risetime to 1 μ sec. This risetime in conjunction with the 1.5 μ sec time constant yield a pulse height at pin 3 of roughly 2.5 volts instead of the expected 5 volts. Thus, the pulse stays within the differential input limit of IC402.

C407 speeds up Q401 turn-on. C402 and C410 steady the +10 volt reference. Pull up resistor R413 allows the gate of Q401 to float to the source potential when CR401 is back-biased (3080 pulse high).

High frequency compensation resistors R401 and R402 correct for the dead time of the integrating capacitor. This time equals the width of the reset pulse (4 to 8 μ sec). The theoretical value for R401 plus R402 = reset time \div integrating capacitor = $(6 \times 10^{-6}) \div (10^{-9}) = 6K$. The amount of compensation in cycles per second is directly proportional to IO (and oscillator frequency). The compensation counteracts "high end droop". It lowers the voltage reached by the positive peak of the sawtooth wave by an amount equal to IO x (R401 x R402). The integration time of the declining ramp is reduced, thereby boosting the frequency.

2.4.2 WAVESHAPER

This voltage controlled circuit shapes the waveform continuously from sawtooth through square and on to narrow pulse. As R414 sweeps from CCW to CW the output of IC403A (Vw) declines from 0V to -10V. At 40% electrical rotation, the sawtooth wave has been totally truncated. At 100% rotation, the output reduces to a very narrow pulse (~ 10 μ sec).

R419 and C409 act to prevent the output from "narrowing to nothing" by putting a spike on the positive swing of the sawtooth wave fed to Q404. R416 allows a modulation sweep roughly equivalent to 100% pot rotation (triangular modulation waveform).

R421, R422, R423 and Q403 constitute the sawtooth truncator. When Vw reaches - 4 volts, Q403 and R421 gobble up all the current that R422 can supply, leaving no signal for summing resistor R423 to feed to signal adder IC403B.

The rectangular wave duty cycle depends on the zero crossing times of the level-shifted sawtooth seen at the base of Q404. When Vw = -5V, the duty cycle = 50%, etc. R437 offsets the level shift slightly so that when Vw = 0, there will be no pulse output, and the sawtooth waveform will be pure.

R424, R425, R426, Q404, Q405 and CR402 comprise a bi-stable zero crossing detector (Schmitt trigger circuit). R424 and CR402 set the common emitter voltage at - 0.7V regardless of the state of Q404 and Q405. This establishes the threshold point of the Schmitt at approximately ground (± 50 mV). Circuit regeneration produces a clean snappy output and the input hysteresis is about 10 mV. Summing resistor R429 feeds the adder IC403B. The AC level of either the pure sawtooth wave or the pure rectangular wave is 2 volts p-p at the output (pin 7).

2.4.3 DOUBLER

The doubler produces exactly 50% duty cycle square waves one octave and two octaves below the primary oscillator pitch. Q406 inverts and level shifts the oscillator reset pulse. The rising edge of this inverted pulse clocks the input of IC404 Section A (connected as a toggle flip-flop). The output alternately transmits from + 15V to 0V and then from 0V to + 15V on the primary sawtooth wave reset pulse. F/F A feeds an identical stage, F/F B. F/F B transitions occur on the positive excursions of F/F A. R431, R432, and R436 attenuate and level shift the octave 1 signal. R433, R434 and R438 do exactly the same to the octave 2 signal.

The octave signals feed the ends of R435. The waveshaped primary signal feeds the center tap. With

the control knob centered only the pure primary signal feeds out the wiper. As the control rotates to either side of center, the primary signal and either octave 1 or octave 2 is mixed with the primary in such a fashion that the summed output level stays approximately constant. At the extremes of rotation, the output consists of about 60% octave and 40% primary (peak-to-peak voltage basis).

One might reasonably ask why R436 and R438 are required to level shift the octave signals down so that their DC level is roughly ground. After all, C506 AC couples the mixed signal into the VCF so the DC shift seems to be unnecessary. However, if R436 and R438 are eliminated, and if one then rotates the DOUBLING knob rapidly back and forth, the DC level at the wiper of R435 will suffer large shifts.



Vw	IC 403B O/P WAVEFORM	COMMENTS
0.0 V		<p>PURE SAWTOOTH 0 % RECT. DUTY CYCLE - 3 VDC OFFSET</p>
~ -0.7 V		<p>RECTANGULAR WAVE APPEARS ONSET OF SAWTOOTH TRUNCATION</p>
~ -2.2 V		<p>SAWTOOTH HALF GONE</p>
~ -3.7 V		<p>SAWTOOTH DISAPPEARS RECT. DUTY CYCLE ~ 40%</p>
~ -5.0 V		<p>50% RECT. DUTY CYCLE - 1 VDC OFFSET</p>
~ -10.0 V		<p>RECT. DUTY CYCLE > 90% (NARROW PULSE)</p>

FIGURE 2-6 WAVESHAPER OUTPUT SHAPE VERSUS WAVESHAPER CONTROL VOLTAGE

C506 will couple the transients to the VCF, momentarily causing the filter ladder to go out of balance and to produce a harsh "gritch" sound. Resistors R436 and R438 alleviate the problem. Also, C506 is chosen so that the coupling time constant into the VCF is about 25 msec (6 Hz) to further preclude difficulties.

2.5 VOLTAGE CONTROLLED LOWPASS FILTER

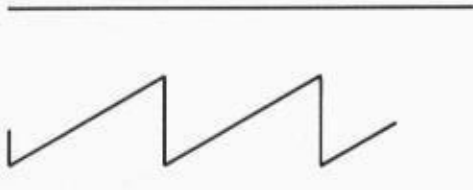
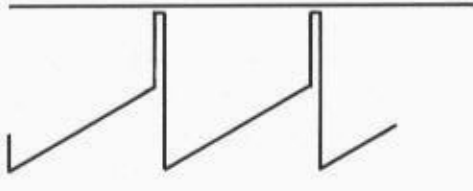
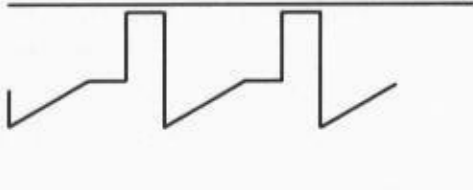
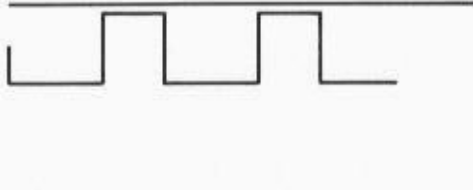
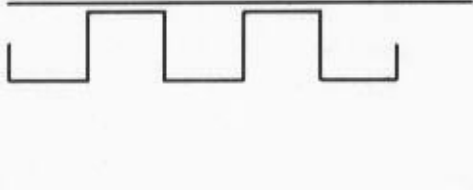
The cutoff frequency of the so-called VCF is actually current controlled by IF. The VCF attenuates high frequency components of the signal while allowing low frequency components to pass through. An emphasis circuit can be brought into play (R525) to peak up the response at the cutoff point. When this is done, the passband level will be uniformly depressed. In the "tone" mode, the emphasis is increased to the point that the filter breaks into oscillation and acts as another tone source accurately playable from 40 Hz to 4 kHz. (See Figure 2-7)

The filter is a refined version of the standard Moog ladder circuit. R502, R503 and R511 attenuate the oscillator output to a low level signal. This AC signal (nominal sawtooth level = 40 mV p-p) feeds to

differential current driver pair Q501 and Q502 at the bottom of the ladder. Q501 and Q502 in turn drive the four filter sections of the ladder (stacked one atop the other). R505 through R510 bias each pair of transistors in the ladder 1.5V above the preceding stage.

C514 and C506 block input DC. C507 bypasses AC signal around R510. C508 and C505 suppress RFI pickup. R501 adds the external audio signal to the VCF input. 100 mV RMS drives the Micro to full output (+12dBm). R504 adds pink noise to the VCF input. R513 limits IF to about 1.2 mA (limits f_c to 60 kHz) so as not to overload Q305. It also protects the ladder from accidental burnout. Note that when SW302 turns the tone oscillator off, it does so by killing the audio feed to the VCF while leaving the oscillator running. This scheme retains capability for filter modulation by the tone oscillator (via C412) when the OSCILLATOR is "off". However, note that when both SW302 and SW303 are off, the oscillator is killed by shorting pin 3 of IC402 to ground. This feature (instituted in newer models S/N 3300 and above) prevents the VCO from bleeding into the VCF when the VCF is acting as a pure sinewave tone source. The bleed would cause generation of impure VCF sinewave tones at high pitch.

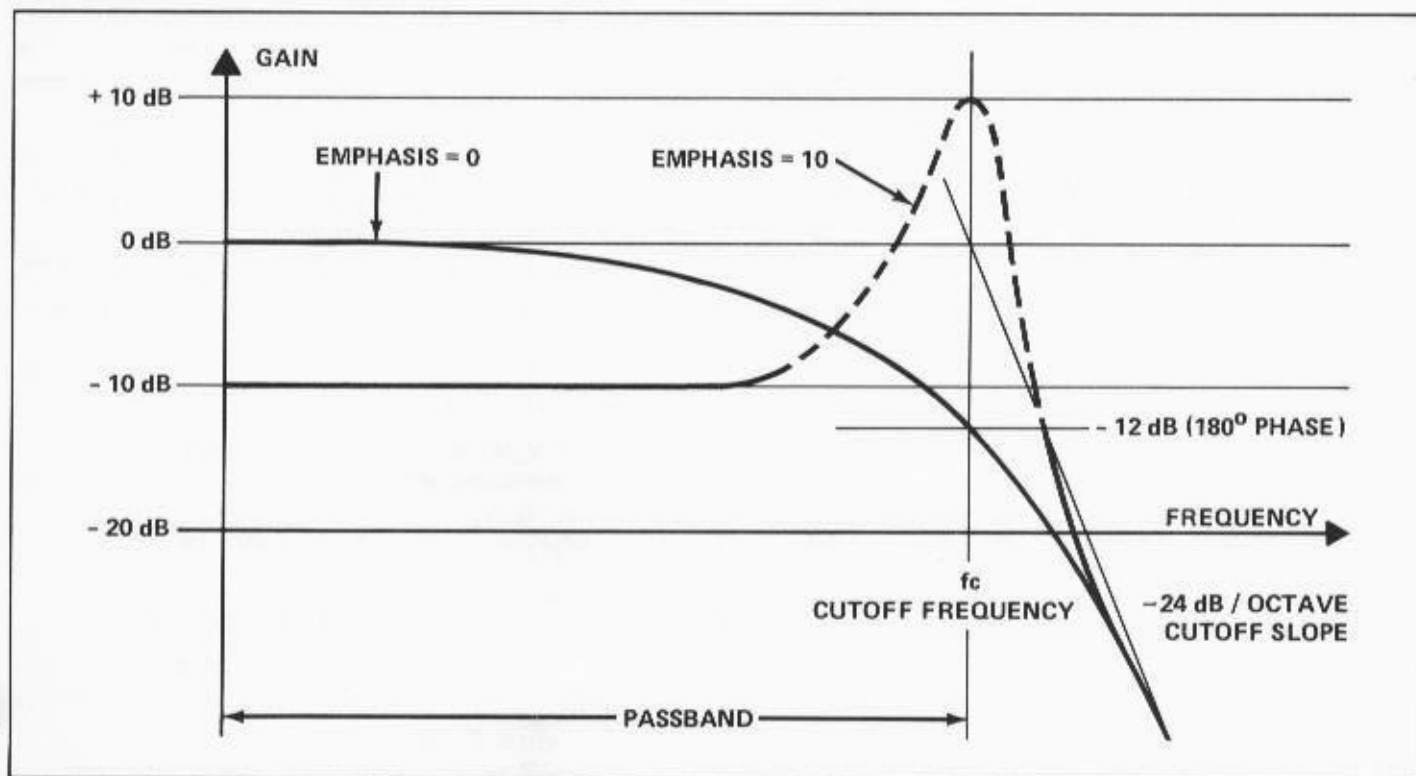

FIGURE 2-7 VCF FREQUENCY RESPONSE CURVES FOR ZERO AND FULL EMPHASIS

Q503, Q504 and C501 constitute the first rung of the ladder. The three identical sections above it constitute the other three rungs. Q501 and Q502 split the control current I_F approximately evenly. One-half I_F flows down the left side through Q503, Q505, Q507 and Q509 while the other half flows down the right side through Q504, Q506, Q508 and Q510. Now the incremental base-emitter junction resistance of a ladder transistor is given by:

$$R_E = \frac{V_T}{I_C} = \frac{25 \text{ mV}}{I_C} \quad \text{where } I_C = 1/2 I_F$$

$$@ I_C = 1 \text{ mA}, \quad R_E = 25 \Omega$$

Since the bases of Q503 and Q504 are connected in series, C501 sees an effective resistance given by:

$$R_F = 2 R_E = \frac{100 \Omega}{\text{mA}} \quad I_F = \frac{100 \text{K}}{\mu\text{A}} \quad I_F$$

The cutoff frequency for the stage is then:

$$f_c = \frac{1}{2 \pi R_F C} \quad I_F = \frac{50 \text{ Hz}}{\mu\text{A}} \quad I_F$$

At f_c the attenuation is 3 dB and the phase shift is 45° for a single rung. Since the collectors of Q503 and Q504 feed the next rung, there is no interaction between these stages or any other stages. We have in effect the following AC circuit. (See Figure 2-8).

This is a four section turnable RC circuit with a cutoff slope of 24dB/octave, 12dB attenuation at f_c and 180° phase shift at f_c .

Note that Q501 and Q502 is not really the idealized linear driver as shown in Figure 2-8. It is actually slightly exponential. However, when the

filter is "wide open" ($f_c = 60\text{kHz}$), the audio frequency input signal is relatively undistorted at the output since Q509 and Q510 present a logarithmic load characteristic. This compensation causes the differential output (seen across the emitters of Q509 and Q510) to have the same level as and to have the same waveshape as the input applied to Q501. Q501, Q502, Q509 and Q510 must be matched and must track well. They are, therefore, contained on a single IC transistor array so the ladder remains properly balanced. The parameters of the other transistors in the ladder are not critical (and these components are not matched).

The input level was chosen rather high at 40 mV (p-p) for good signal to noise (S/N) ratio. The high level drive results in appreciable harmonic distortion, but this is harmless (if not beneficial). There is, of course, no intermodulation distortion to worry about in a one oscillator instrument. The level could even be higher if we didn't have to worry about excessive overdrive masking the effects of emphasis.

Q514 and IC501 comprise a differential input, single sided output, gain recovery amplifier. Dual J-FET Q514 acts as a dual source follower to keep IC501 from drawing input bias current directly from the top of the filter ladder. If permitted, this drain would throw the ladder severely out of tune at low frequencies. R517 sets IC501 amplifier bias current (IABC) into pin 5 at 500 uA, about the highest level practical. A lower value of (IABC) would degenerate the S/N ratio of the gain recovery amp and also impair its frequency response at the high end of the audio spectrum. R518 and R519 set the output DC level of IC501 to + 6V and R517, R518 and R519 set

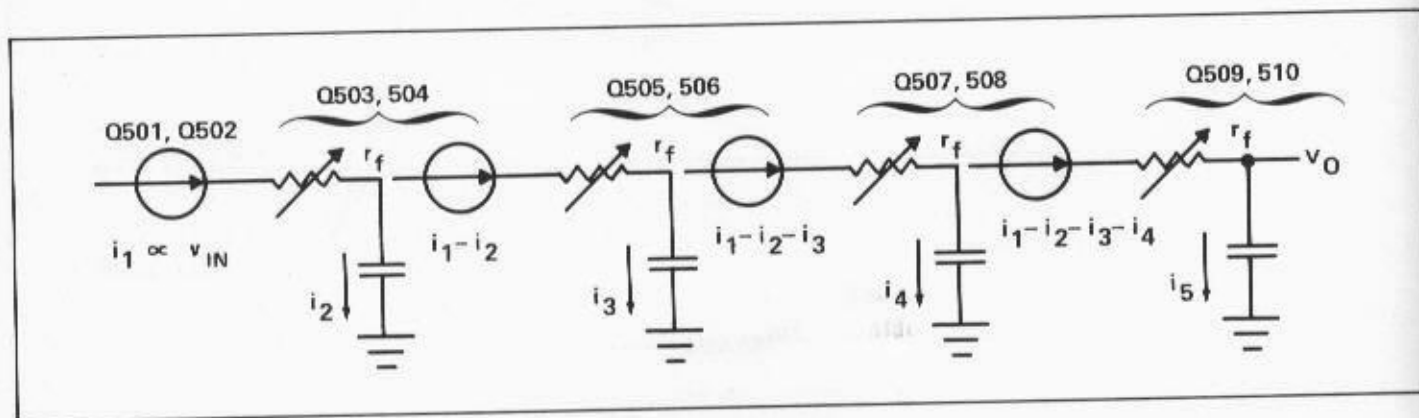

FIGURE 2-8 EQUIVALENT FILTER LADDER CIRCUIT

its AC gain to + 40dB. A Darlington follower (Q512, Q513, and R521) buffers the output to provide low impedance drive to the emphasis circuit. R527 protects the buffer transistors from accidental burnout should the emitter of Q513 be shorted to ground.

The emphasis network feeds back to ladder driver Q502. In the passband, the feedback subtracts from the input signal (180° phase shift) causing the overall level to drop. At the cutoff frequency, however, the 180° phase reversal contributed by the ladder results in a net shift of 0° (positive feedback) and a regenerative peak appears in the frequency response curve - i.e., "emphasis".

Now here is what we want. In the "norm" and "full" modes, the filter MUST NOT quite oscillate at any f_c with the emphasis knob (R525) fully up. This will be true if the loop gain remains slightly less than unity.

In the "normal" and "full" modes of SW510, R522 and R524, attenuate the feedback 26dB. Now with R525 = 0, we adjust R526 for a little more loss (about 2dB) and the overall loop gain nears unity. + 40dB (amplifier) - 12 dB (chain) - 26 dB (emphasis feed) - 2 dB (trim) = 0 dB. Actually R526 is set so the loop gain = - 0.5dB. This yields a strongly resonant peak with Q of ~10 max (threshold of oscillation).

Now here is the other constraint: in the "tone" mode, the filter MUST oscillate (act as a sinewave tone source) from 20 Hz to 10 kHz. In the "tone" mode, R523 instead of R522 feeds the emphasis network which boosts the loop gain to + 2.5 dB. Secure and stable oscillation results. In the "tone" mode SW501 shorts R525 so that oscillation will occur no matter where the EMPHASIS knob is set. During oscillation the ladder self limits at about 40 mV p-p resulting in the same output level one would obtain from the VCO. The output is a quite pure sinewave that is very accurate when played from the keyboard (over the full range of the synthesizer). If the VCO audio feed to the filter remains on while the filter produces its own tone, we obtain a very nice effect. When the filter frequency is near the tone oscillator frequency (or a harmonic of the oscillator frequency), the filter will lock onto the tone oscillator.

Nominally f_c should exactly double each time V_F (base of Q305) rises 19.55 mV. However, at higher frequencies f_c does not rise quite high enough ("high and droop") causing the pitch of the oscillating filter to go flat in the 4' and 2' ranges. It is found that to compensate for the error we need to boost the pitch by an amount proportional to f_c .

To compensate properly, IC304 derives positive feedback from otherwise spare transistor Q304. Q304 parallels Q305 so that $I_{F'} = I_F$. At 1 kHz, R369 develops about 4 mV which feeds at a gain of roughly 2 through IC302B. After attenuation by R354 and R355, this signal amounts to about .2mV (1/100 of an octave or 20 cents). R357 trims this corrective feedback. R376 limits $I_{F'}$ so as not to overload Q304 or IC303A. R376 also prevents danger of latch up of IC302B due to excessive positive feedback.

2.6 VOLTAGE CONTROLLED AMPLIFIER

Here the versatile 3080 is found in another application - that of a variable gain amplifier. One section of the Dual Contour Generator produces an envelope buffered by IC602A. As the voltage envelope swings to its maximum value of + 9V, R608 establishes a current proportional to the envelope voltage with a peak value of 500 uA which flows through level shifter Q601. This bias current passes into IC601 pin 5 to control its gain. With no bias current flowing, IC601 shuts off completely. Otherwise, the signal gain is proportional to the bias current.

The signal output current of IC601 passes to the AC current-to-voltage converter comprised of R609 and IC602B. IC602B acts as the output buffer and drives VOLUME pot R612. Protective devices R611, CR601 and CR602 prevent external static discharges or chassis potential differences from damaging IC602B. C605 keeps DC out of the output and C604 suppresses oscillation. R613 supplies a DC output ground reference for IC601. R614 provides sensing so that fault isolation can be accomplished at the output of IC601. When "On", SW601 keeps the VCA fully on regardless of the envelope voltage. R607 limits the drive to IC601 to 500 uA (Q601 will saturate) during bypass or when the articulator contour generator is in the sustain mode.

The signal input to IC601 is 40 mV peak-to-peak so as not to severely overdrive it. The 47 ohm input impedance shunts the considerable input current

noise of the 3080 and also shunts input bias current offset. R606 trims VOS of the 3080 to eliminate clicks and thuds.

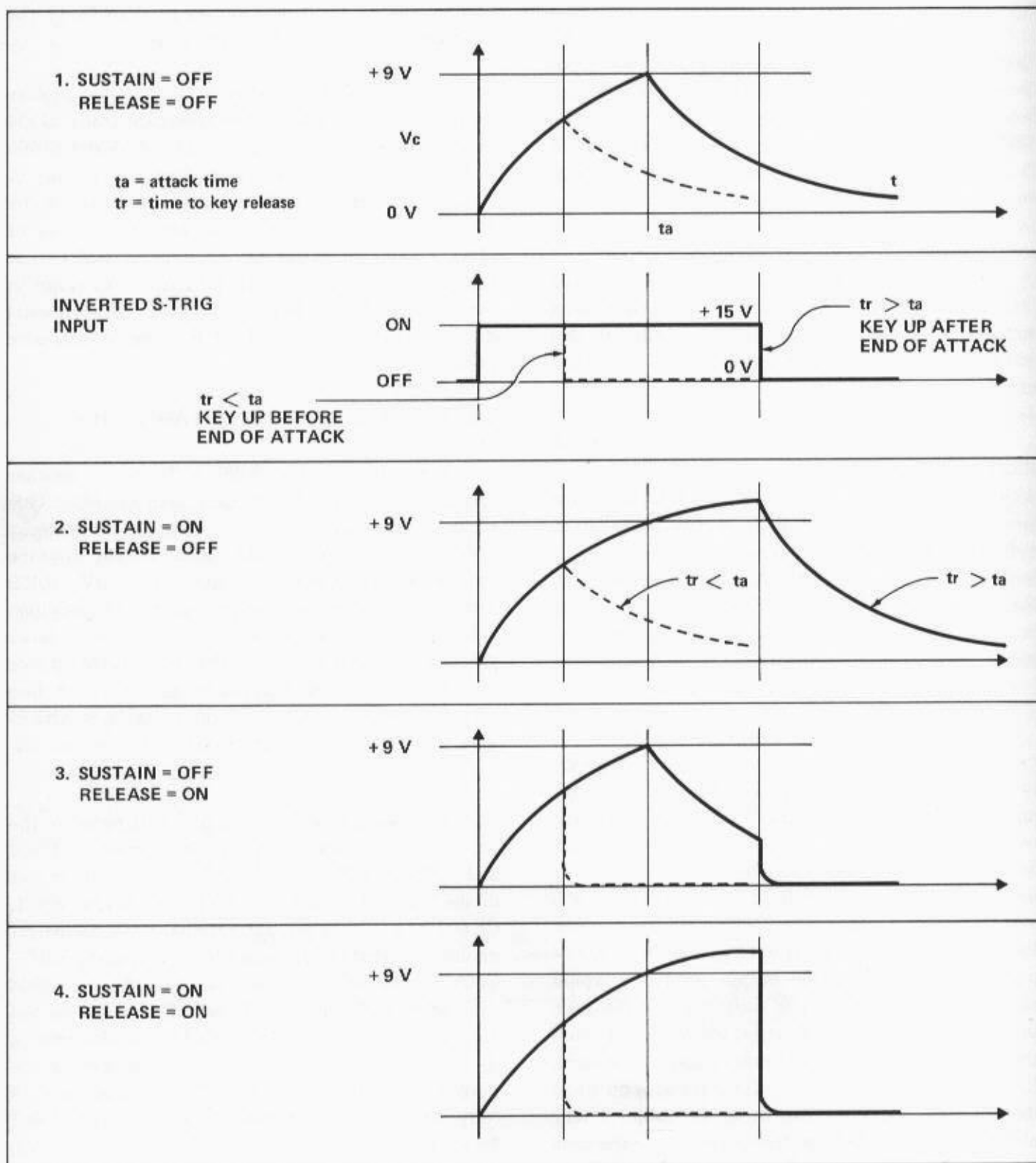

FIGURE 2-9 ENVELOPE SHAPE (EITHER SECTION) AT TIMING CAPACITOR C705 OR C706

2.7 DUAL CONTOUR GENERATOR

In the quiescent state, the outputs of both sections of the dual contour generator remain at zero volts (viewed at timing capacitors C705 and C706). The trigger (which may come from either the keyboard, external input or modulation oscillator) simultaneously initiates the action of both sections. Each section independently generates a one-time voltage waveform as shown in Figure 2-9. Both sections work exactly the same way so the detailed explanation is confined chiefly to loudness contour section A.

The 556 IC contains two separate bipolar timing circuits in a single package. Section A controls the loudness contour circuit. Under "no trigger" conditions, Q702 grounds pin 4, forcing the timer into the RESET state. Both the pin 5 main OUTPUT (active pull-up and active pull-down) and the pin 1 DISCHARGE output (open collector grounded-emitter NPN transistor) remain near zero volts. The contour output decays to zero as C705 drains via R705.

When the synthesizer produces a trigger, R716 pulls up pin 4 to + 15V (far above the RESET threshold of 0.7 volts) which enables the timer to respond to a trigger pulse applied to pin 6. At the same time C701, R701, R702, R703 and Q701 generate a 1 μ sec negative-going pulse. This pulse momentarily forces the timer TRIGGER input below its + 4.5 volt threshold and the timer latches itself on. The DISCHARGE output floats and the main output goes high. C705 charges at a rate set by R704 to produce the attack portion of the contour. R706 keeps the minimum charging time above 1/2 msec

(limits instantaneous charging current to 150 mA). The attack continues until the feedback to the THRESHOLD input reaches + 9 volts.

At the threshold point, the IC701 internal latch resets and both pin 5 and pin 1 go low. CR701 prevents R704 from influencing the decay. C705 discharges toward ground at a rate set by R705 to produce the decay portion of the contour. Again, R705 keeps the minimum time constant above 1/2 msec (discharge current below 100 mA). Figure 2-9, contour No. 1, illustrates the resultant waveform.

NOTE

If the trigger ceases during the attack, the timer resets before the output reaches maximum level and the circuit immediately goes into the decay portion of the contour (dashed line). Also note that if a new trigger occurs during the decay, the new attack starts up from the level of the contour at the instant of trigger application and not from zero volts.

When open, SW701 disconnects C705 from the THRESHOLD input. This defeats automatic transition into the decay mode and the contour sustains at a high level until the trigger ceases and the timer resets via pin 4. See Figure 2-9, Contour No. 2. During sustain, the voltage on C705 will rise several volts above the nominal peak of + 9 volts. R607 however, limits the control current to IC601 to 500 μ A so that the loudness does not rise above the no-sustain maximum level. SW701 gives the performer the option of having or dispensing with finger-sustain.

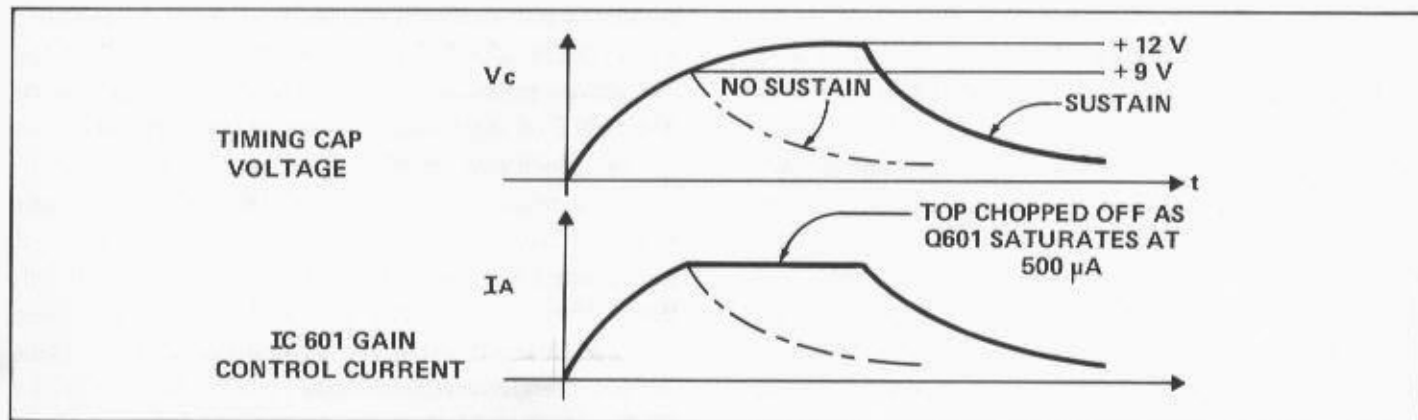

FIGURE 2-10 LOUDNESS LIMITING

Often the performer will want the sound to cease immediately at the end of a note (fast release). When SW702 is on, it effectively bypasses R705. As soon as the inverted S-trigger goes low, C705 discharges quickly via R707 and CR703. See Figure 2-9, Contours No. 3 and No. 4. R707 sets the fall time to 10 msec to soften the release somewhat. CR703 and CR704 isolate the two contour sections from each other and also prevent current from R716 from charging C705 and C706 when Q702 is off. CR705 compensates for the base emitter drop of Q601 so that notes will die out more gradually at the end of the contour "tail".

Section B of IC701 controls a filter contour generator identical to the loudness contour generator (up to C706). A reversible attenuator follows C706. The network consisting of R711, R712, R713 and the CW half of R715 attenuates the output of buffer IC702A and shifts down the level to yield a contour that starts at -2.5 volts and sweeps up to +2.5 volts. This contour feeds the CW end of linear center-tapped pot R715. R713, R714 and IC702B develop the inverted contour applied to the CCW end of R715. When the wiper of the pot remains roughly within $\pm 10^\circ$ of the center tap, the wiper will stay in the electrical dead band of the pot and no contour output feeds to the filter control voltage summing amp.

As the wiper moves toward the CW end, a positive-going sweep centered on zero volts feeds out. As it moves toward the CCW end, a negative going sweep centered on zero volts feeds out. The zero-centered sweep makes adjustment of the filter cutoff control non-mandatory when the performer changes AMOUNT control R715 from positive to negative sweep.

C703 and C704 return unused control pins 3 and 11 to ground to keep them from picking up noise. C702 bypasses the + 15 volt supply to squelch oscillation. R718 and C707 decouple the large supply current transients (300 ma max.) of IC701 from the + 15V supply.

The loudness contour section employs R607 to limit sustain mode loudness to approximately the peak value achieved in the no-sustain mode. Likewise, provision must be made to limit the actual contour applied to the filter so that the sustain mode cutoff

frequency is the same as the peak value achieved in the no-sustain mode. Furthermore, the limiting here must be much more precise than with loudness. The potential at pin 3 of IC701 happens to be within 10 mV or so of the threshold potential at pin 2. Therefore, emitter follower Q703 and R720 is connected to pin 3. The diode CR706 in conjunction with R719 now acts to limit the potential at IC702A, pin 3, to the threshold potential. The resultant voltage contour seen at IC702A, pin 1 will look just like the loudness current contour shown in Figure 2-10.

2.8 MODULATION

The modulation oscillator synchronously generates two subsonic waveforms, one triangular and one square. R803 and R804 attenuate to ± 1.5 volts the raw ± 14 volt square output developed at pin 1 of IC801A thereby setting the triangle amplitude to ± 1.5 volts. R801 and C801 integrate the raw square wave into a triangular wave. Adjustment of R801 changes the frequency from 0.3 Hz ($\pm 40\%$) to 30 Hz ($\pm 40\%$).

R805, R806 and R807 attenuate and level shift the raw square wave so that square wave modulation of the tone oscillator will yield an upward going trill. R810 and R816 trim the trill so that the lower frequency point does not shift as the modulation wheel rolls up. The raw square wave output triggers the contour generators (50% duty cycle) in the "S & H Auto" mode. It also continually clocks the Sample and Hold circuit.

SW801 selects from among the six sources of modulation and it selects also the source of contour generator triggering. The trigger source is always keyboard-plus-external except in the "S & H Auto" mode. Buffer IC801B prevents loading of C801 in the triangular mode of modulation. IC801B drives AMOUNT of modulation wheel R1007. R1007 has a special clockwise modified log taper. From 0° to 50° , the resistance from the CCW lug to the wiper increases from 0 to 1K ohm. From 50° to 100° , it rises from 1K ohm to 10K ohm. At the 100° point, the resistance from the wiper to the CW lug is nominally zero. Mechanically, the wheel rotates 100° . Thus, the pot sweeps over its full 100° electrical range in the 100° rotation of the wheel. The modulation signal passes through the normally closed switch contacts of

J7 on its way to routing selector SW802. If an external network is jacked into J7, the contacts open up and the external network acts with R1007 to influence the modulation. The external network may consist of a switch or a resistance foot pedal. The jack diameter of 0.206" keys it for passive I/O (resistors, switches, capacitors, etc.) rather than voltage I/O.

R812 and R813 attenuate the ± 14 volt signal so as not to overdrive the base of Q801. Q801 drives the S-trigger external output plug. Current limiter R815 protects Q801 from burnout. Resistor R814 provides pullup to drive Q702.

2.9 NOISE SOURCE SAMPLE AND HOLD

2.9.1 NOISE SOURCE

IC901 generates pseudo random noise using its internal clock and shift register. The output peak-to-peak excursion is fixed. The time interval from transition to transition varies randomly enough to produce an aural effect very similar to that of a true random amplitude generator. Since the shift register repeats about once every second, a small "heartbeat" effect mixes in with the white sound.

C902 couples the white noise to the "pink" -3dB/octave weighting filter comprised of R902, R903, C903 and C904. R905 attenuates the pink noise and R504 sums it into the audio mix mode. R906 and C905 roll off the pink signal even further to produce red noise. Red noise is used directly for modulation and it also serves as the random signal input for the Sample and Hold circuit. R901 and C901 keep high frequency noise hash from leaking back to the + 15 volt supply. A top side ground plane shields this circuit from radiating noise into other nearby circuits.

2.9.2 SAMPLE AND HOLD

On the positive transition of the modulation oscillator, C909, R910, R911, R912, and CR901 couple a 1-1/2 msec current pulse into the program input of IC902. IC902 turns on momentarily to close the Sample and Hold loop and cause a sample of the instantaneous noise amplitude to be taken. The output

that appears at the source of Q901 when the loop closes, exceeds the level at the loop input (IC902, pin 3) by a factor of 7 due to R908 and R909. As soon as the program current pulse dies out IC902 shuts off completely (leakage current less than 1 nA). Holding capacitor C908 then keeps the FET source follower output constant. The maximum drift rate equals 2 mV/sec which implies a tone oscillator drift rate of 20 cents a second. IC902 may have to be selected (i.e., try several in the socket) to reduce this drift rate.

The maximum output current of IC902 equals the magnitude of the program current pulse. A full slew from -1.5V to +1.5V will take about 2-1/2 msec.

$$\Delta T = \frac{C \Delta V}{I} = \frac{(C908) (3V)}{(30V)/(R911)} = \frac{(.5 \times 10^{-6}) (3)}{(30) \div (5 \times 10^4)} = 2.5 \text{ msec}$$

This is sufficiently fast to sample red noise without signal averaging since the transition rate caused by the 100 Hz rolloff implies a slew time at pin 3 of about 5 msec.

The maximum charge deliverable to C908 equals the amount fed into pin 5 during the turn-on pulse. The size of C909 has been chosen to deliver an adequate program charge as shown below:

$$Q_{C909} = C \Delta V = (3 \times 10^{-8}) (30) \cong 10^{-6} \text{ coulombs}$$

$$Q_{C908} = C \Delta V = (.5 \times 10^{-6}) (3) \cong 1.5 \times 10^{-6} \text{ coulombs}$$

2.10 MISCELLANEOUS OFF-BOARD COMPONENTS

R4 supplies 12 mA from the - 15 volt supply to illuminate the pilot light (red light emitting diode). The + 12 dBm high level output (J2) directly drives low sensitivity power amps to full output. It also drives headphones, especially high impedance phones, pretty well. R1 and R2 lower the J1 output to - 10 dBm for feeding a pre-amp or standard electric music accessories (fuzz, phase, etc.) at the input levels they require.

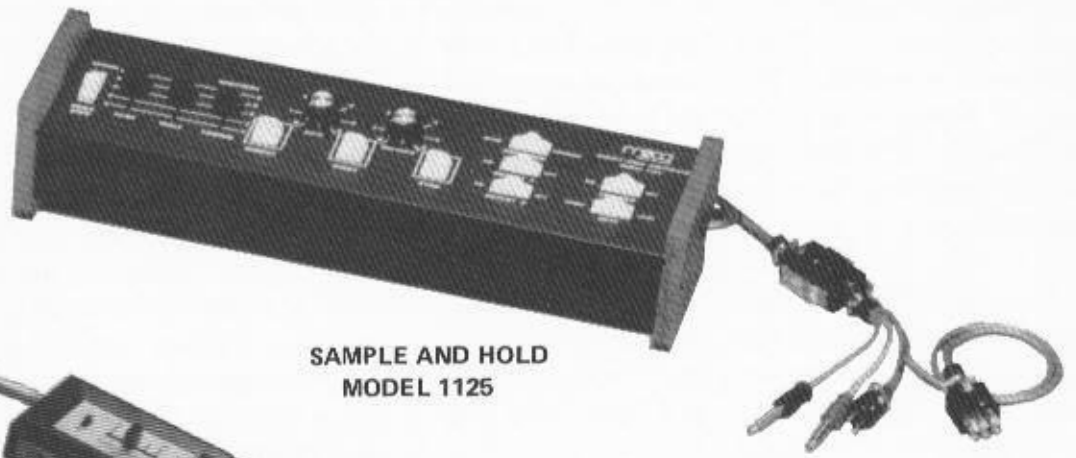

SAMPLE AND HOLD
MODEL 1125

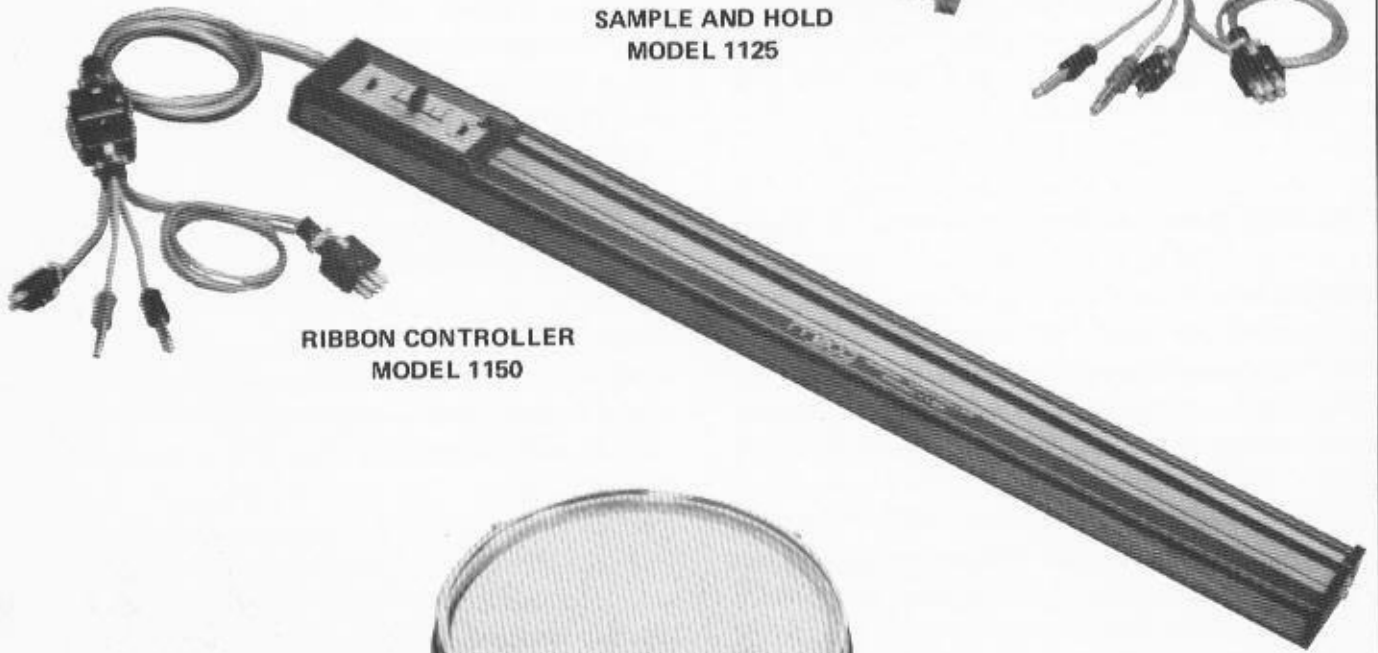

RIBBON CONTROLLER
MODEL 1150



PERCUSSION CONTROLLER
MODEL 1130



FOOT SWITCH
MODEL 1121



FOOT PEDAL CONTROLLER
MODEL 1120

MOOG ACCESSORIES

SECTION 3 DISASSEMBLY PROCEDURES

3.1 OPENING THE SYNTHESIZER

The synthesizer separates into two major sections. The upper part (the case) contains the main circuit board and the left hand controller. The lower portion (the base) mounts the keyboard, power supply and rear panel assembly. To open the instrument, remove the 7 screws as indicated in Figure 3-1 and proceed as follows:

a) Pull up on the back of the case, slide the case forward to clear the key tips and lift off. Partially open the case and pry apart the 3-pin audio output cable connector. Note how cable and connector lie atop the main PC board so as not to interfere with the tails of the keys. (See Figure 3-2)

CAUTION

When re-assembling, be sure to put the cable in its original position. If the connector rests on key tails, the tails will vibrate against the connector.

b) Depress top of clamp firmly to release the main cable. Carefully note the portion of the cable that the clamp holds. Releasing the cable makes the case and base parts much simpler to reach for servicing. (See Figure 3-3)

c) The sections that can be serviced at this first stage of disassembly are shown in Figure 3-4. These include the AC fuses, transformer, power supply, keyboard control-out board, keyboard and rear panel pots, switches and jacks.

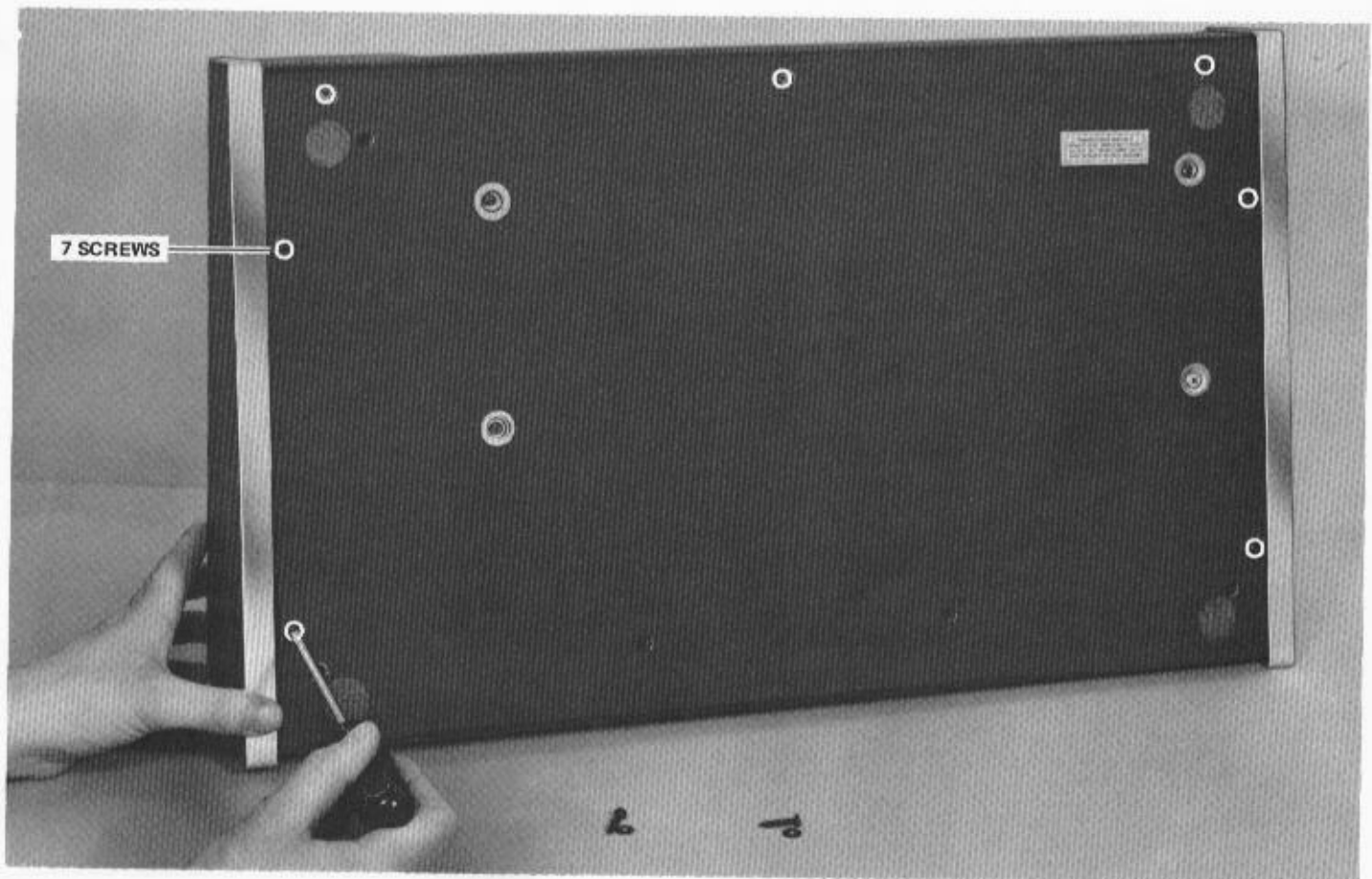

FIGURE 3-1 REMOVING CASE FROM BASE

d) A "fish paper" cover shields the hazardous AC line voltage wiring to the left of the transformer. The top of this cover may be pushed forward to give access to the fuses.

CAUTION

Lethal voltages are under the AC cover. Unplug unit before lifting cover to replace fuses or service other parts underneath.

e) The power supply mounts on studs with spacers under the board to provide for air circulation beneath the pass transistors. The board may be electrically disconnected by removing its connectors. Simply pull up on the 3-pin AC input connector. The 9-conductor DC output plug must be pried open using a flat-bladed screwdriver to assist removal and to avoid damage to the terminal pins on the wires.

f) Several rear-panel sockets and switches are riveted in. To replace such a part, drill off the head

of the rivets. Install replacement part using a 4-40 machine screw and nut with a lockwasher under the nut.

g) Several service functions can be performed on the keyboard without removing it from the base. Early units (prior to approximately Serial No. 2500) were built without insulation on the key pivot tabs which caused the keyboard to short out against the main PC board. All such units should have a grommet (916-041636-001, 17-3/4 inch) installed. Press the strip on over the tabs as shown in Figure 3-5.

h) Damaged "ivories" may be replaced as shown in Figure 3-6. Remove keyscrew, tip the back end of the ivory up about 20 degrees and slide ivory forward. It will be necessary to remove adjacent white ivories to remove a black ivory.

i) Occasionally a key will be higher or lower than its neighbors when in the up position. To level the key, remove the ivory and bend the stop tab under the key up or down with keyboard height adjustment tool. (See Figure 3-7)

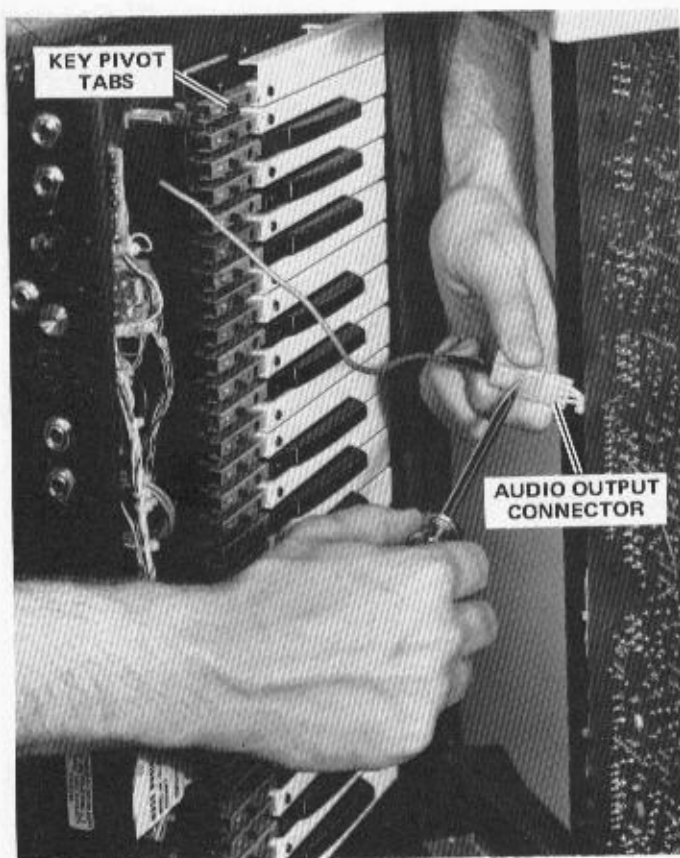

FIGURE 3-2 UNPLUGGING AUDIO OUTPUT CONNECTOR

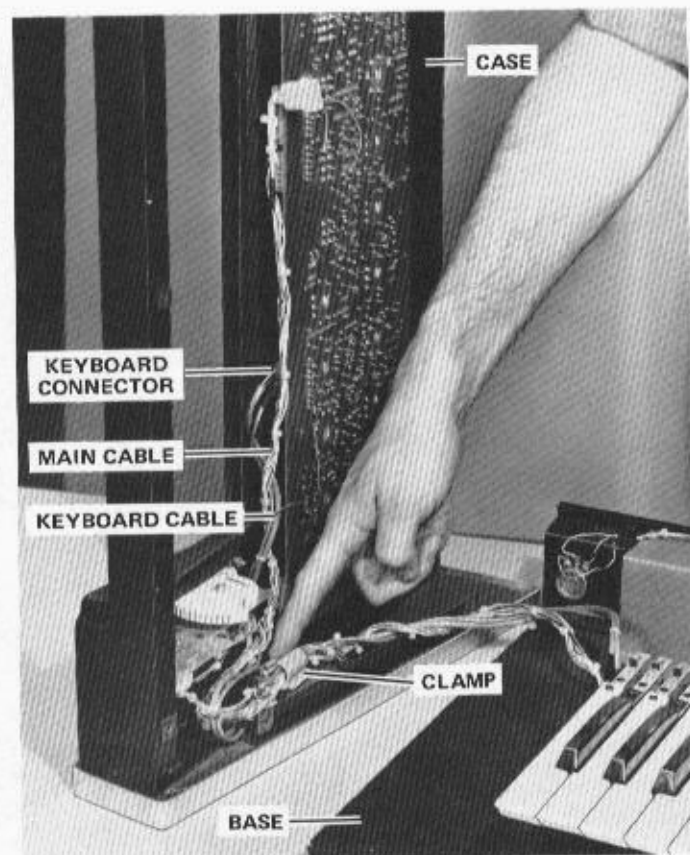

FIGURE 3-3 UNLOCKING CABLE CLAMP

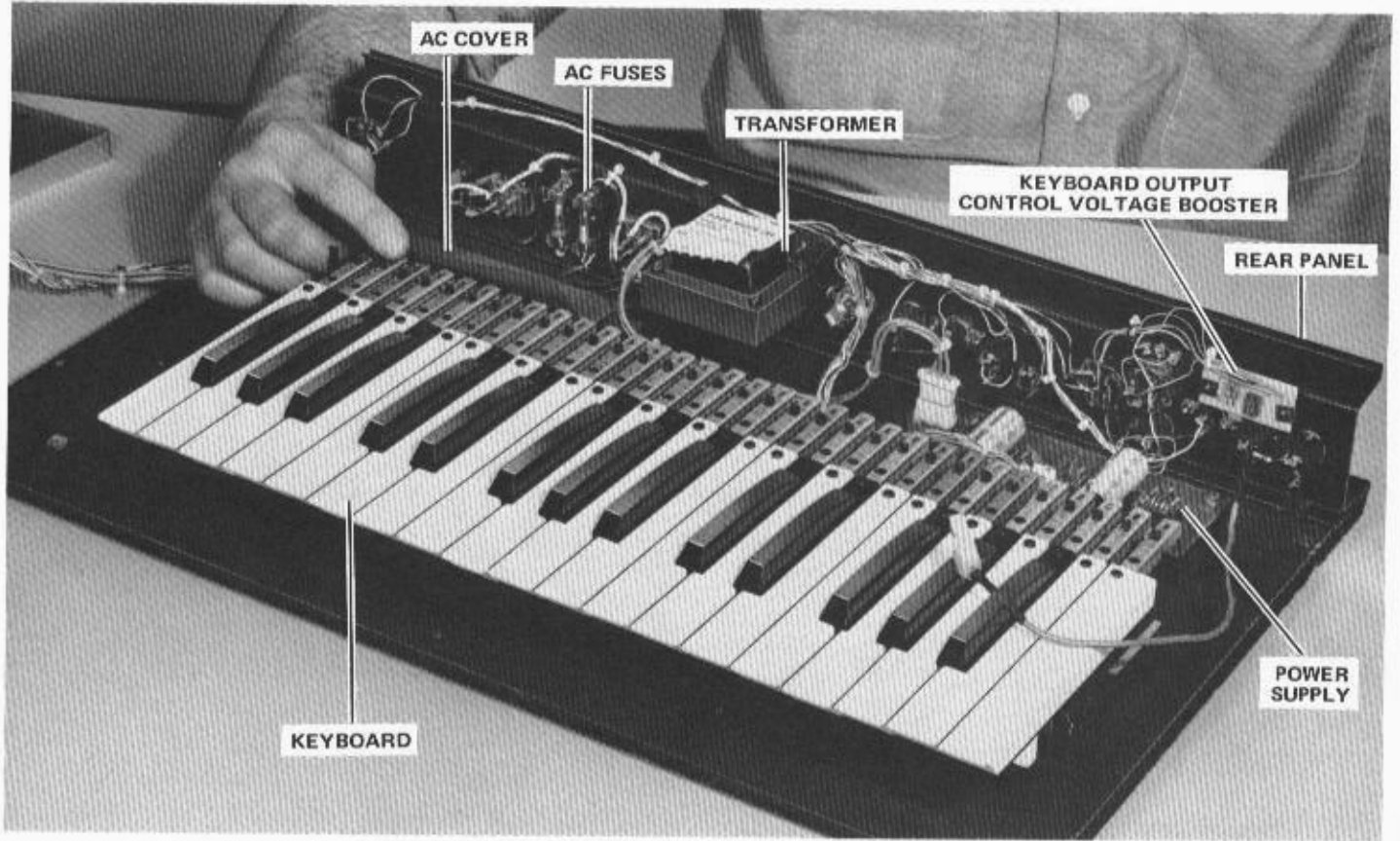

FIGURE 3-4 BASE ASSEMBLY

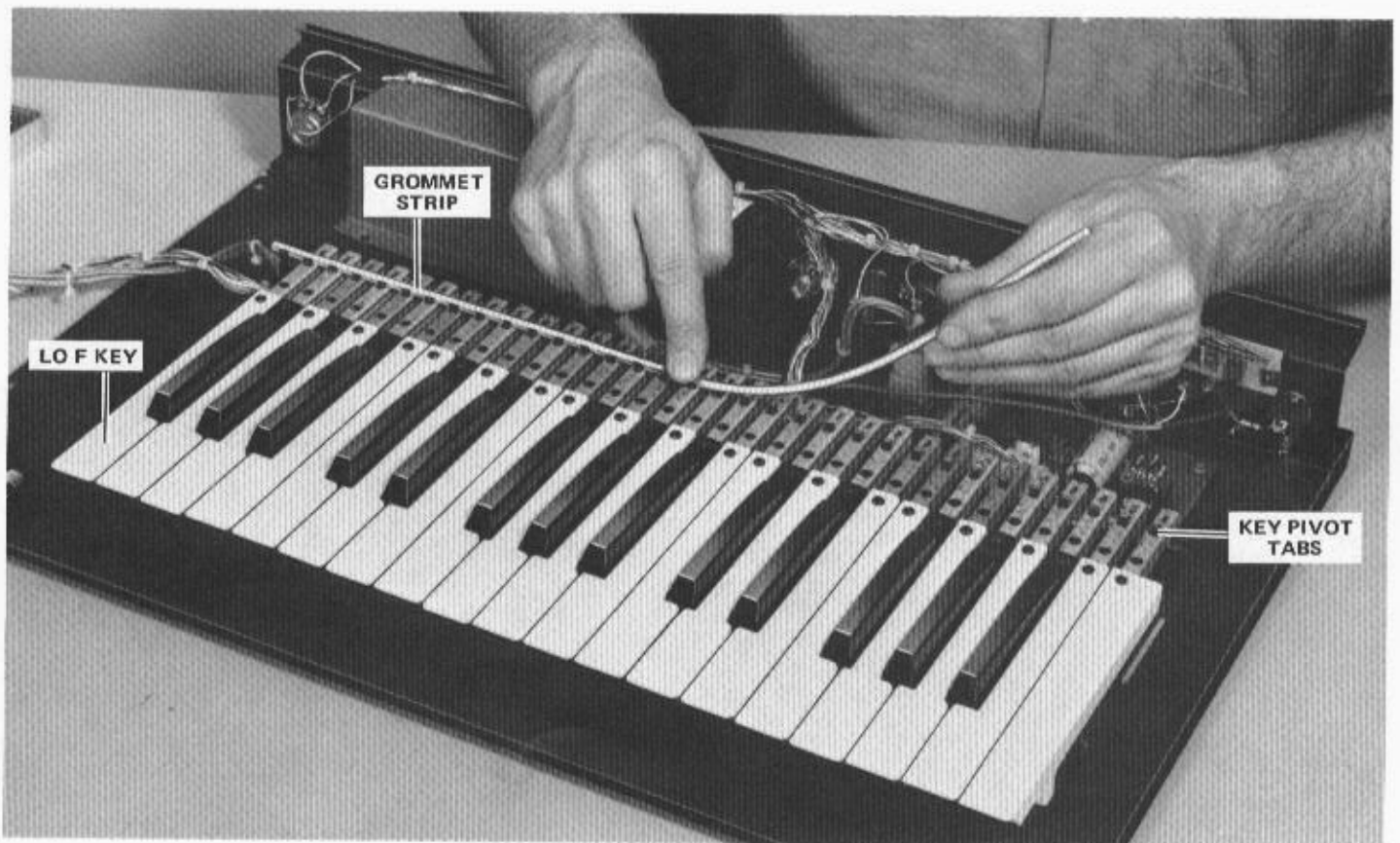

FIGURE 3-5 INSTALLATION OF GROMMET STRIP



FIGURE 3-6 REMOVING IVORIES

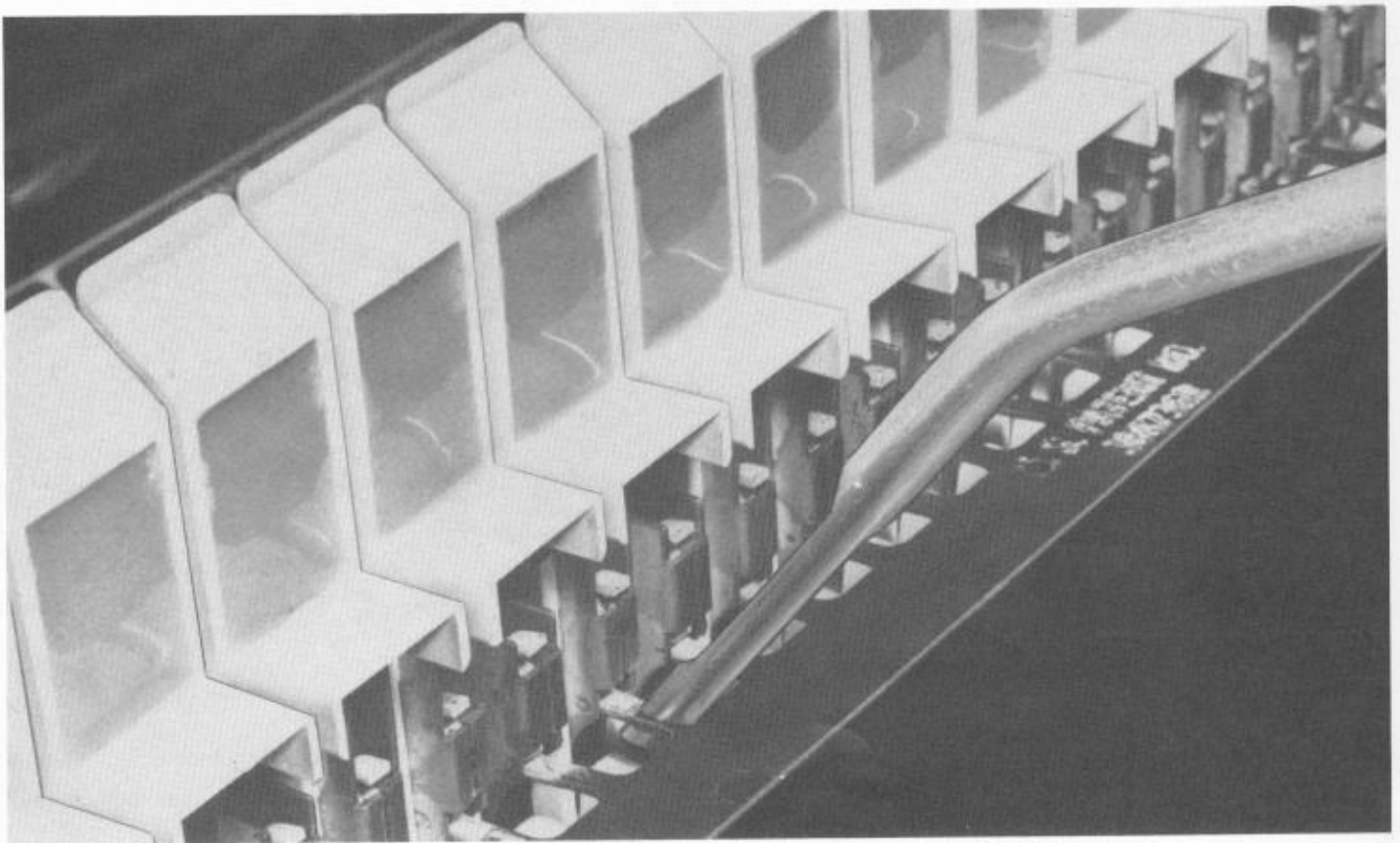

FIGURE 3-7 KEYBOARD HEIGHT ADJUSTMENT TOOL

3.2 KEYBOARD REMOVAL

The keyboard must be removed to service the key contacts. Also removal of the keyboard makes replacement of the keysprings much easier to accomplish without damaging or losing springs. See Figures 3-9 and 3-10.

a) To remove keyboard, take out the four mounting screws (see Figure 3-8). The keyboard cable wraps around the main cable and can be separately removed by unplugging the keyboard connector from the main PC board (see Figure 3-3). Once the keyboard cable is unwound, the connector may be plugged in again and the keyboard may be placed on the table and played in a normal fashion.

CAUTION

Key ivories will mar. To protect finish, put a cloth or patch of carpeting down on the workbench before turning keyboard upside down.

b) Note that cup washers (904-040948-006) were not used on early units. They should be routinely installed on all units. (See Figure 3-8)

c) Keysprings provide the return force for the keys. The springs are color coded to indicate their tension. Black keys require a greater tension and use RED springs. White keys use BLACK springs. (See Figure 3-10)

3.3 MAIN PC BOARD REMOVAL

First pull off all front panel knobs and caps. Grasp a knob with thumb and forefinger of both hands and pull hard. Tight fitting knobs may require wrapping a cord around the shaft to assist removal. (See Figure 3-11)

a) Turn case upside down and remove the six nuts that hold the PC board to the case studs (see Figure 3-12). Lift out the PC board and place on bench in front of keyboard. In this service position (see Figure 3-13), all electrical points in the instrument are accessible for testing and probing while the instrument remains fully operable.

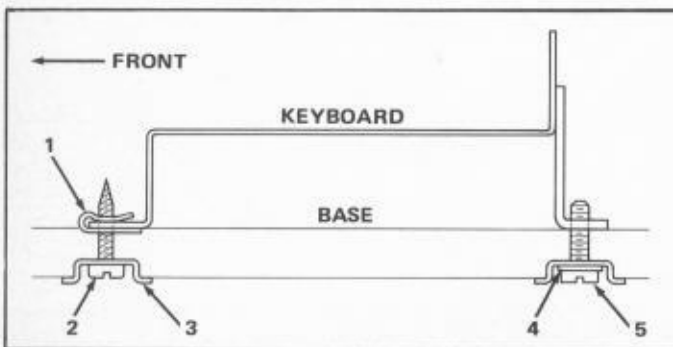

KEYBOARD MOUNTING PARTS LIST			
ITEM NO.	PART NUMBER	DESCRIPTION	QTY.
1	902-040500-005	No. 8A Speednut	2
2	811-050039-012	No. 8 x 3/4 Self Tapping Screw	2
3	904-040948-006	Cup Washer.	4
4	904-041395-008	No. 8 Lockwasher	2
5	806-055039-012	8-32 x 3/4 Screw	2

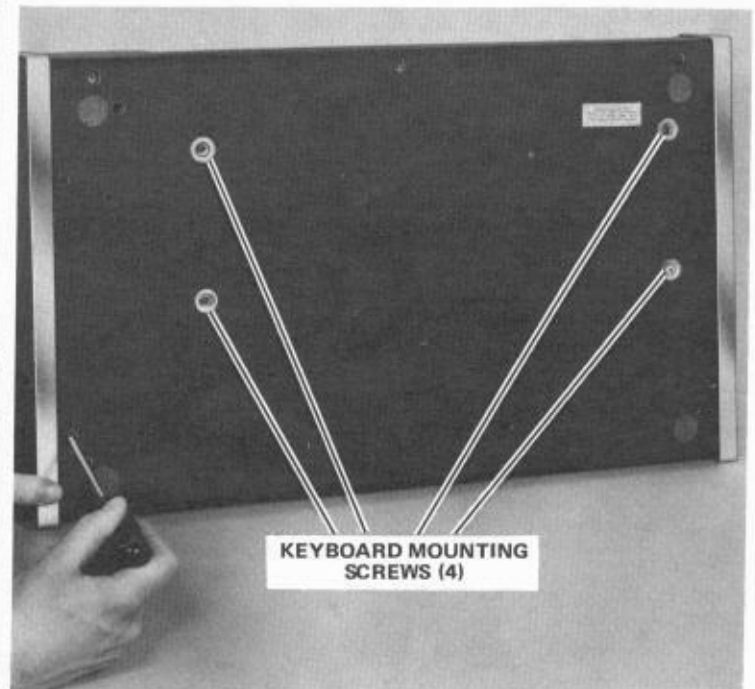

FIGURE 3-8 KEYBOARD MOUNTING

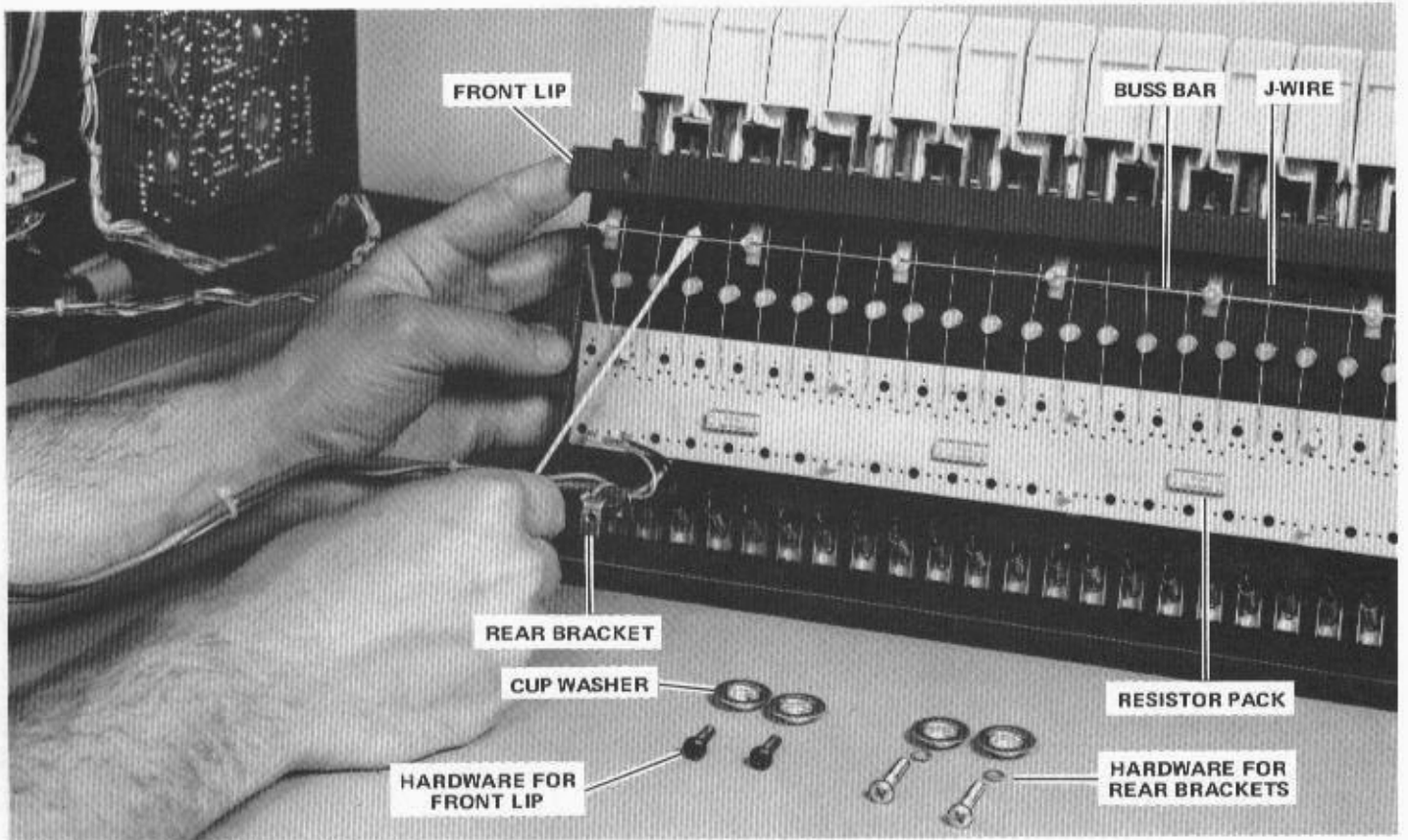

FIGURE 3-9 SERVICING SWITCH CONTACTS

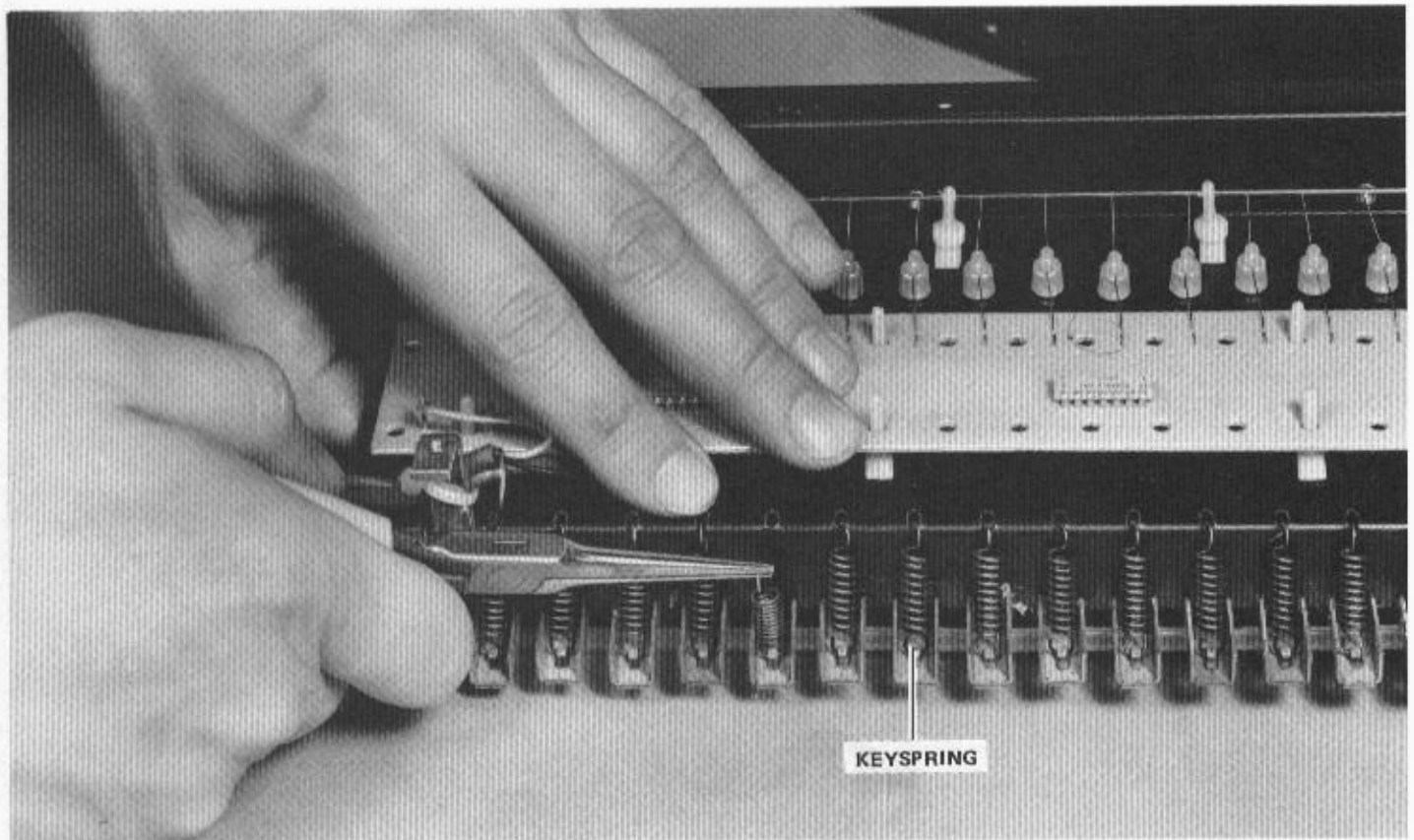

FIGURE 3-10 KEYSRING REPLACEMENT

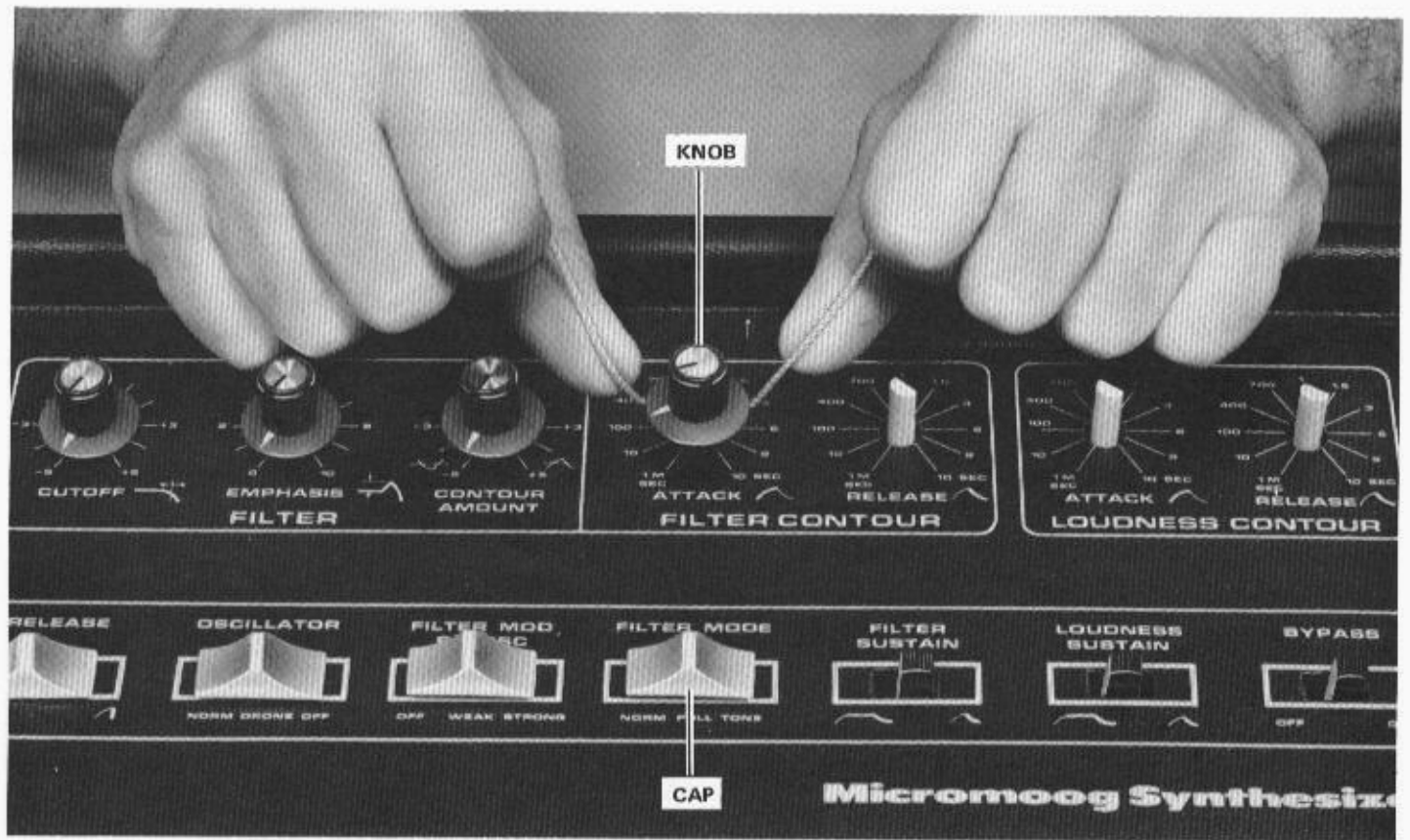

FIGURE 3-11 KNOB REMOVAL

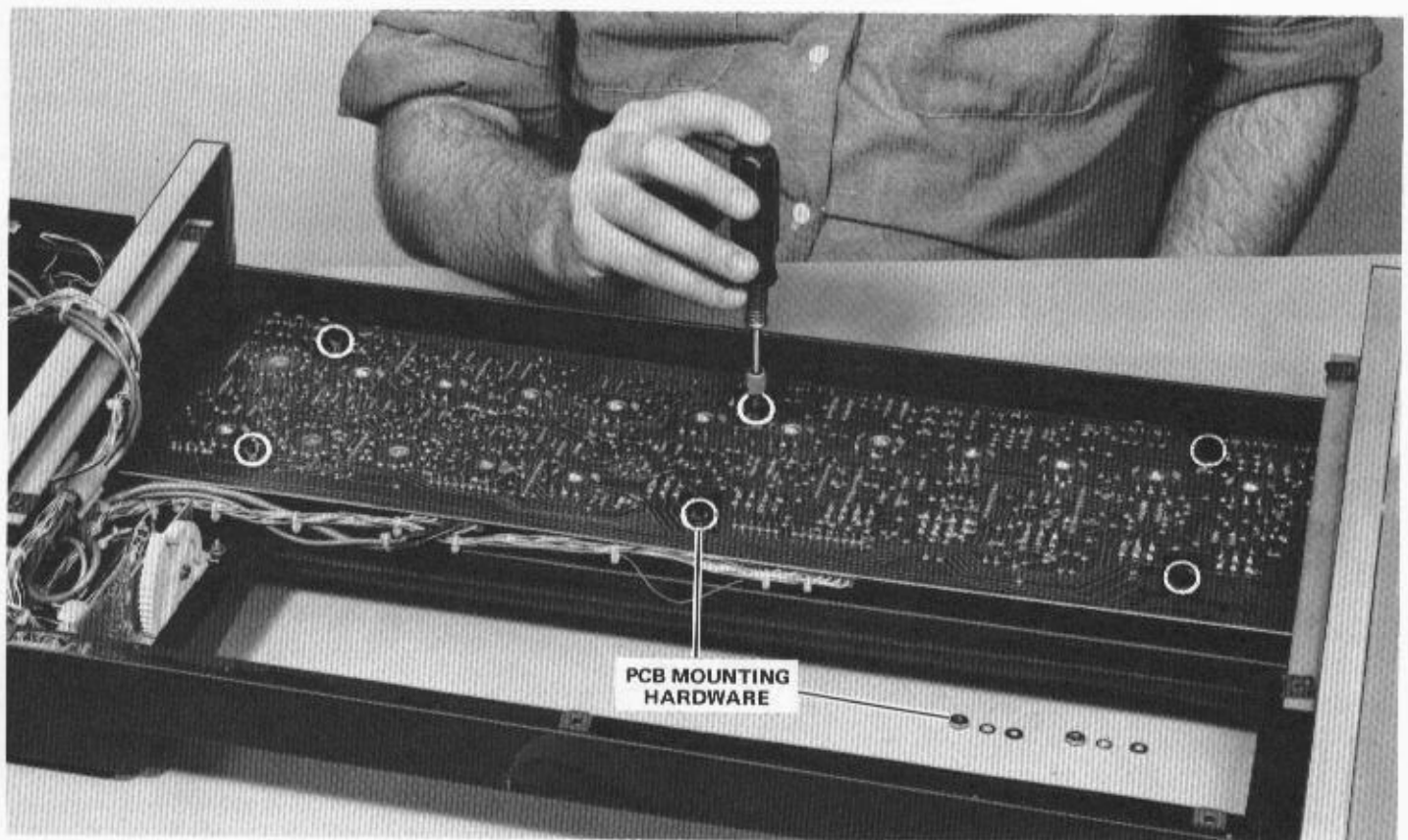

FIGURE 3-12 PC BOARD REMOVAL

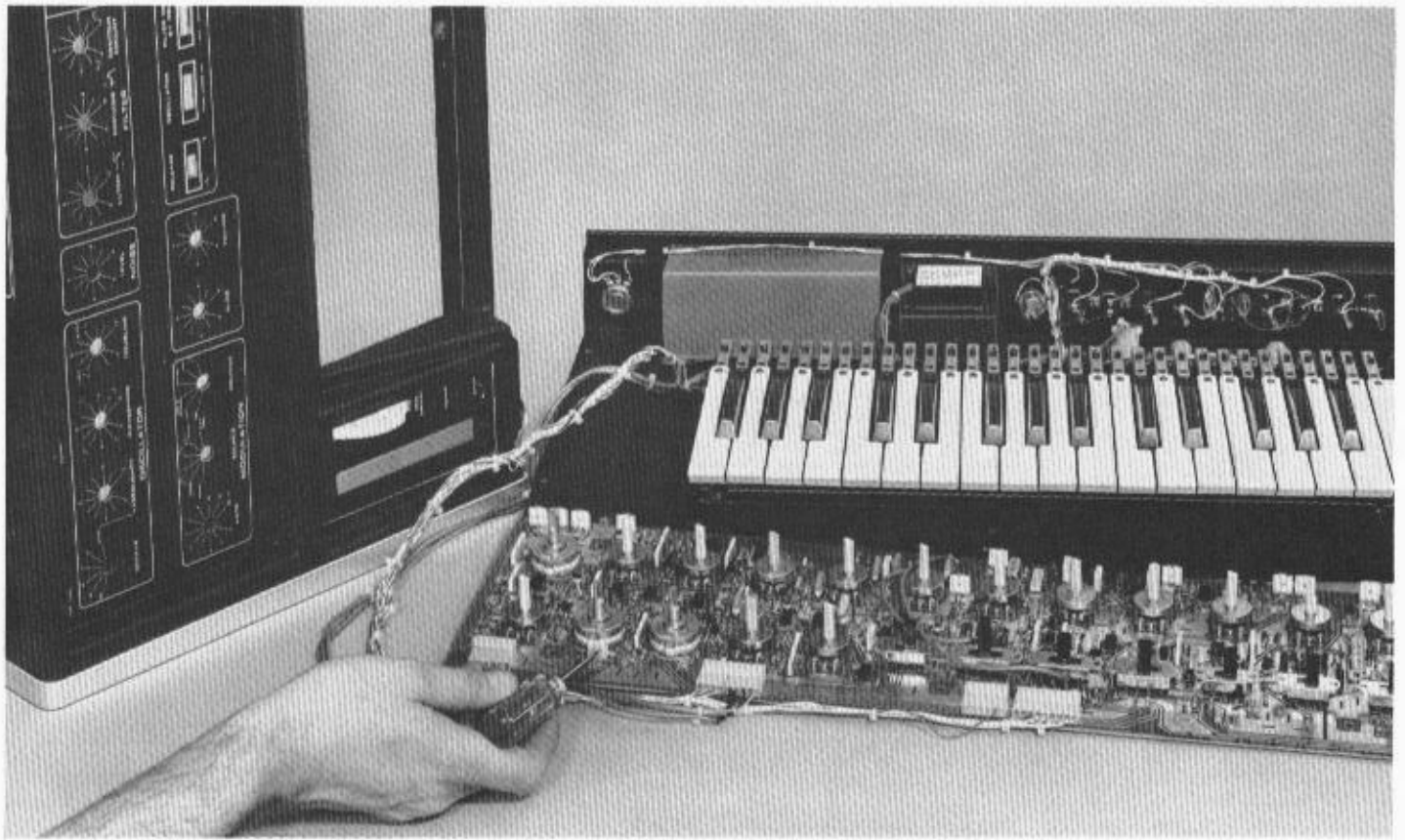

FIGURE 3-13 PC BOARD IN SERVICE POSITION

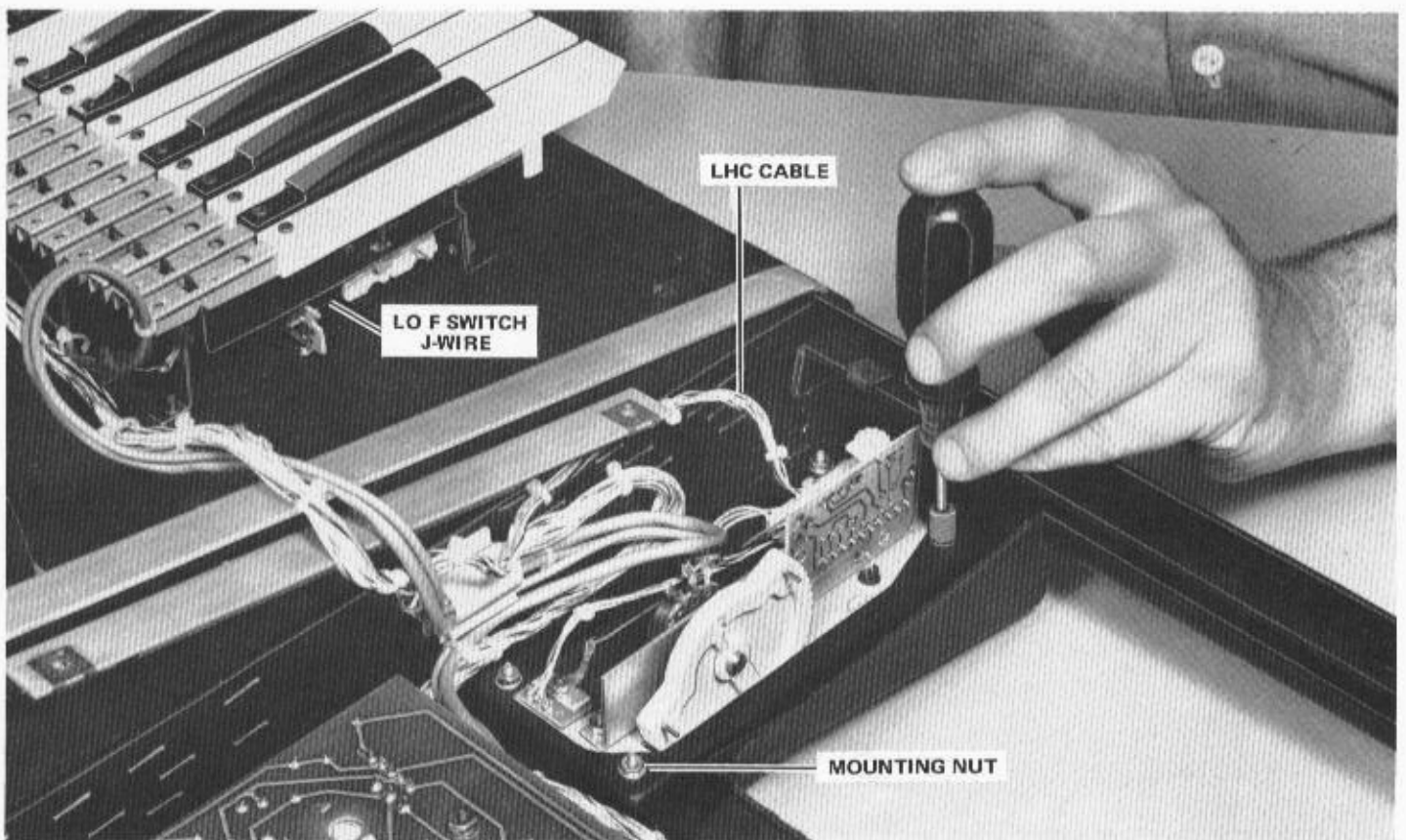

FIGURE 3-14 LEFT HAND CONTROLLER REMOVAL

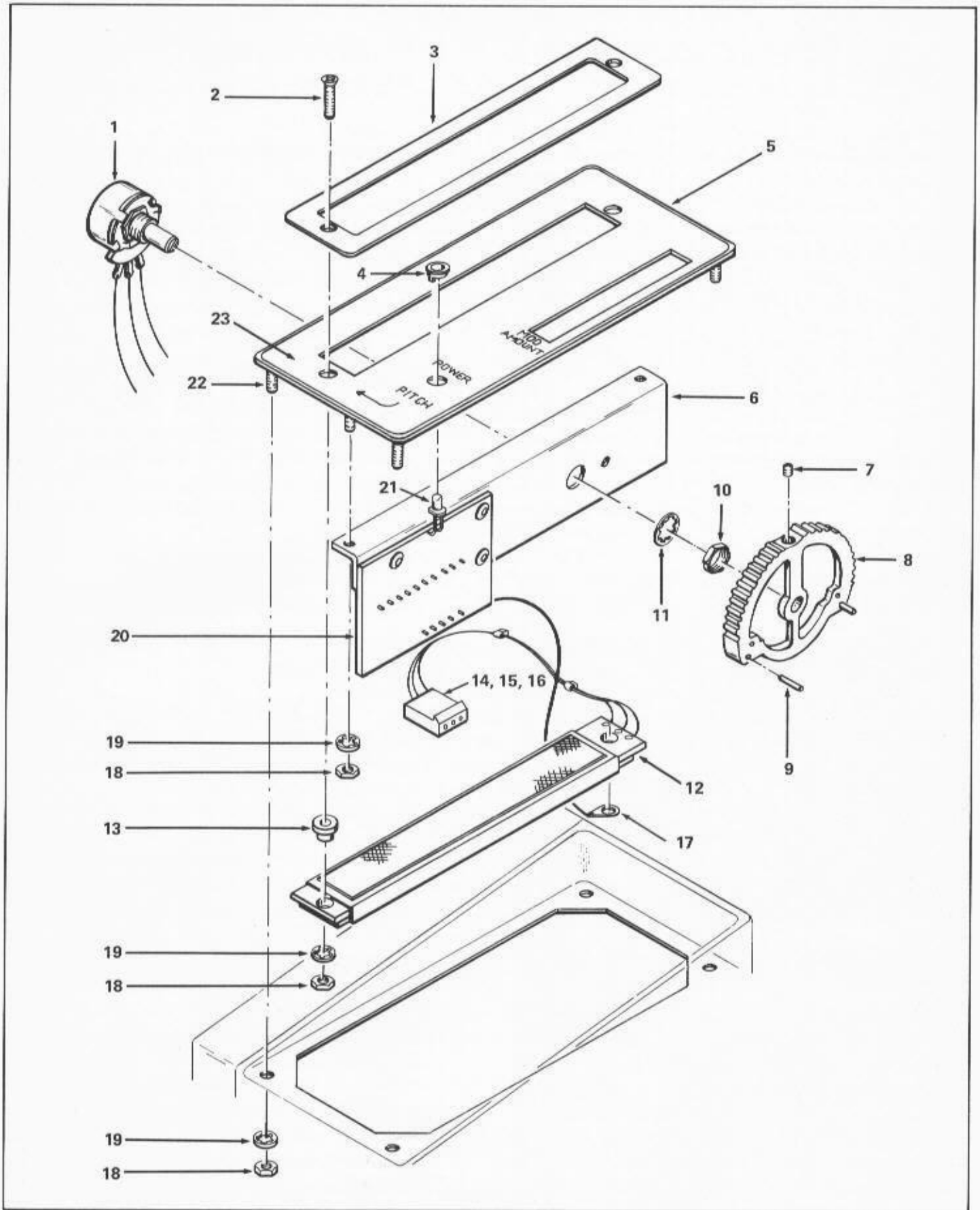

FIGURE 3-15 LEFT HAND CONTROLLER ASSEMBLY, PART NO. 997-041463-001

TABLE 3-1 MICROMOOG LEFT HAND CONTROLLER ASSEMBLY
REPLACEMENT PARTS LIST

INDEX NO. OR REF DESIG	PART NUMBER	DESCRIPTION	QTY
1 (R1007)	997-041463-001	Left Hand Controller Assembly consisting of:	
2	925-040269-001	Resistor, Rotary Pot, 10K Ohm, Special Taper	1
3	806-023539-008	Screw, Oval Hd., Black, 4-40 x 1/2 in.	2
4	947-040863-001	Bezel, Ribbon	1
5	976-040293-001	Clip, LED Mounting	1
6	963-040858-001	Plate, Mounting	1
7	967-040857-001	Bracket	1
8	996-041597-001	Left Hand Control Wheel Assembly consisting of:	
9	903-040486-062	Setscrew, No. 6-32	1
10	964-040865-001	Wheel, Controller	1
11	909-040938-002	Dowel Pin	2
12	902-040504-007	Nut, 3/8 x 32	1
13	904-040495-021	Washer, Lock, 3/8 in.	1
14	997-040585-001	Ribbon Assembly	1
15	904-040601-004	Washer, Shoulder	2
16	910-041718-003	Terminal Housing, 3P Molex	1
17	910-041720-001	Terminal, Molex	3
18	908-042856-001	Bushing, Insulated, Teflon	3
19	911-041351-002	Lug, No. 4, Ground Locking	1
20	801-023221-000	Nut, 4-40	4
CR1001,	904-040495-015	Washer, Lock, No. 4	3
CR1002	996-041594-001	Left Hand Controller Printed Circuit Board Assembly	1
P7	919-041075-001	Diode, 1N4148, Alternate 1N914	2
	910-042531-010	Header, Printed Circuit Board, 10 Pin Straight, AMP1-640445-0	1
R1001,R1006	853-312102-001	Resistor, 1K Ohm, ±5%, 1/4W	2
R1002	925-042526-001	Resistor, Trim Pot., 1K Ohm	1
R1004	852-312105-001	Resistor, 1 Megohm, ±5%, 1/4W	1
R1005	852-312152-001	Resistor, 1.5K Ohm, ±5%, 1/4W	1
	980-040862-002	Printed Circuit Board	1
21	939-040920-001	LED FLV117	1
22	911-041307-008	Stud, Clinch, 4-40 x 3/8 in.	6
23	913-040860-001	Overlay	1

3.4 LEFT HAND CONTROLLER (LHC)

This assembly mounts to the case with four nuts. After removing the LHC from the case, it may be detached from the main cable harness by unplugging the 7-pin connector.

a) The left hand controller comes apart as shown in the blow-apart diagram (Figure 3-15). The ribbon sub-assembly (item 12) is not field repairable and should not be taken apart. It may be removed by taking out the two screws (item 2).

b) Mark the orientation of the bezel (item 3). Occasionally the bezel will not fit properly when turned around. The ribbon connects electrically via a 3-pin plug.

CAUTION

A thin 1/4-inch wide strip of nichrome metal inside the ribbon assembly acts as the contact. It extends the full length of the assembly and is easily bent, ruining the ribbon. Always handle this part gently.

SECTION 4

TUNING AND ADJUSTMENT PROCEDURES

4.1 EXTERNAL AND INTERNAL ADJUSTMENTS

Normally, the Micromoog does not require re-tuning very often as it is an exceptionally stable instrument. However, always re-tune it as a routine part of any service work because replaced parts may affect adjustments. Also trimpot settings may be disturbed during disassembly and handling.

Most trimpots are accessible to the owner through the three holes at the rear of the instrument case. The only tools required for these adjustments are a medium-size flat bladed screwdriver, an F reference tone, (tuning fork, pitch pipe, organ, another synthesizer, or a lab oscillator) and of course, your ears.

CAUTION

Do not use excessive force when inserting screwdriver. Trimpots can be damaged.

A scope helps considerably because you can observe the reference tone mixed with the audio output to get a visual indication of beating.

Four adjustments can be reached only by opening the instrument. Three of these (- 15 ADJ, VCF BAL, and CHIP TEMP) require test equipment to set and are concealed within the instrument to keep unqualified people from making improper adjustments. The fourth (FILT RNG) is not very critical and should never require adjustment unless R320 (CUTOFF CONTROL) gets replaced.

4.2 EXTERNALLY ACCESSIBLE ADJUSTMENTS

Place the synthesizer on end as shown in Figure 4-1. The upper lip of the rear panel has labels to identify the trimpots. Connect the Micromoog to an amplifier/speaker, turn on Micromoog and allow to warm up for 10 minutes. This gives the thermostatted oscillator circuit time to stabilize at its 55°C operating temperature.

You may tune the filter without first tuning the oscillator (i.e., no interaction). However, the oscillator or filter tuning steps should be done in the order indicated (first RANGE, second SCALE, third HI END, fourth OCTAVE). The procedure recommends a 700 Hz reference tone for oscillator tuning and a 350 Hz reference tone for filter tuning. These are the best frequencies to use if you are using a sinewave generator for a reference tone. However, any F will do.

4.2.1 OSCILLATOR TUNING

Set up the controls as shown in Figure 4-2. These settings will remain unchanged throughout the oscillator tuning procedure.

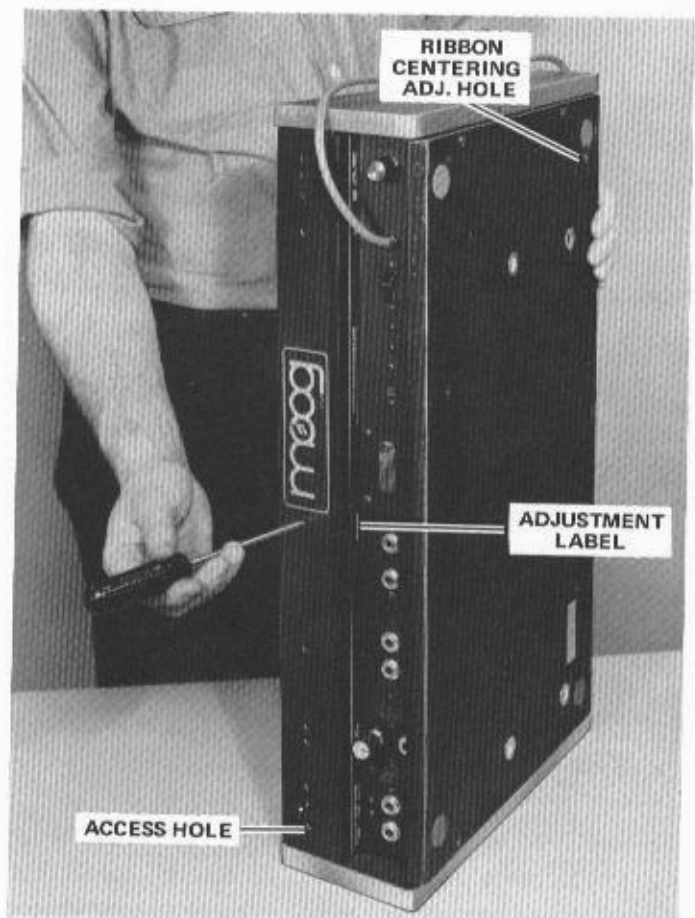
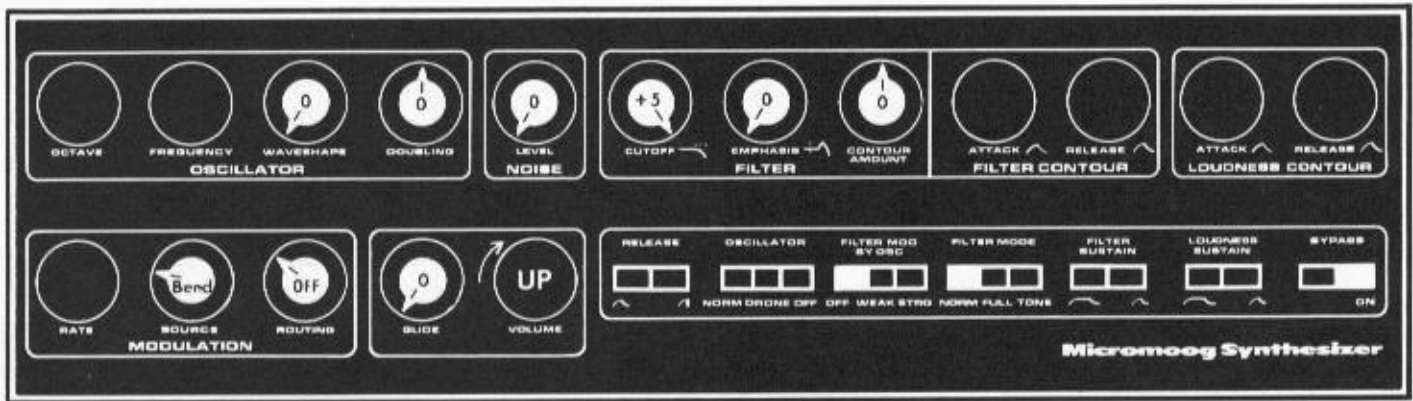

FIGURE 4-1 POSITION FOR MAKING EXTERNALLY ACCESSIBLE ADJUSTMENTS



NOTES: Settings of unmarked controls either unimportant (or given in procedure).

FIGURE 4-2 OSCILLATOR TUNING SOUND CHART

4.2.1.1 OSCILLATOR RANGE

OSCILLATOR = DRONE

OCTAVE = 2'

FINE TUNE (REAR PANEL) = VERTICAL
(12 o'clock)

Compare Micromoog pitch to a reference tone of F above high C (700 Hz if you are using a lab oscillator = F5).



Adjustment is required if the Micromoog FINE TUNE must be moved a significant amount from vertical to achieve unison with the reference tone. To adjust, set FINE TUNE to vertical and turn OSC RANGE trimpot with the screwdriver so that the Micromoog sounds a perfect unison with the reference tone (no beating with reference tone).

4.2.1.2 OSCILLATOR SCALE

OSCILLATOR = NORM REF TONE = F5 (700 Hz)
OCTAVE = 8'

a) Depress and hold LO F on the keyboard. Zero beat Micromoog with reference tone using FINE TUNE control so that Micromoog sounds a perfect 2 octave interval below the reference.

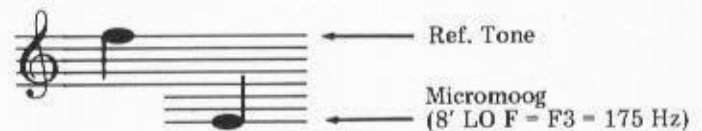

b) Depress and hold HI F on the keyboard. Turn OSC SCALE trimpot so that a perfect unison with the reference results (zero beats).

4.2.1.3 OSCILLATOR HIGH FREQUENCY COMPENSATION

OSCILLATOR = NORM
OCTAVE = 2'

a) Depress and hold LO F. Zero beat with F5 (700 Hz) reference using FINE TUNE control.

b) Depress and hold HI F. Adjust OSC HI trimpot for zero beats.

OSC SCALE AND OSC HI interact slightly. Go back and repeat steps 4.2.1.2 and 4.2.1.3.

4.2.1.4 OSCILLATOR OCTAVE STEP

OCTAVE = 2'
OSCILLATOR = DRONE

a) Zero beat with F5 (700 Hz) reference using FINE TUNE control.

b) Set octave to 16' and adjust OSC OCT trimpot for zero beats. Recheck 2' position.

NOTE

OSC RANGE and OSC OCT adjustments do not interact with each other; nor do they interact with OSC SCALE. OSC HI does affect OSC OCT and should be checked before adjusting OSC OCT.

4.3 FILTER TUNING

Set up controls as shown in Figure 4-3.

4.3.1 EMPHASIS

The EMPHASIS trimpot calibrates the EMPHASIS front panel control as follows. When FILTER MODE = "Tone", the filter is supposed to act as a wide range (50 Hz - 5 kHz) sinewave oscillator tone source (irrespective of setting of EMPHASIS control). When FILTER MODE = "Norm" or "Full", the filter is not supposed to oscillate (howl) even when the EMPHASIS control = 10 (no matter what the cutoff frequency happens to be). If the EMPHASIS trimpot is too far CW (clockwise), the filter may either refuse to oscillate altogether in the "Tone" mode, or it may not produce a tone over the full 50Hz - 5kHz range. If the EMPHASIS trimpot is too far CCW (counterclockwise), the filter may break into oscillation in the "Norm" or "Full" mode. We set the EMPHASIS trimpot to satisfy both conditions (no oscillation in "Norm" and "Full", sure-fire oscillation in "Tone").

OSCILLATOR = OFF
 OCTAVE = 4'
 FILTER MODE = FULL
 EMPHASIS control = 10
 STRIKE LO F

a) Turn EMPHASIS trimpot fully CCW. Sweep CUTOFF control back and forth from - 5 to + 5. After each sweep, turn the EMPHASIS trimpot CW a little until no oscillation occurs at any setting of the CUTOFF control. Listen especially carefully to the low bass region since low frequency sinewaves (below 30Hz) are pretty hard to hear. The objective is to set the filter just below the threshold of oscillation. This makes the filter resonance as pronounced as possible when the EMPHASIS control = 10.

FILTER MODE = TONE

b) Sweep CUTOFF from - 5 to + 5 to insure that the filter oscillates over the full musical range (i.e. make sure EMPHASIS trimpot is not too far CW).

4.3.2 FILTER SCALE

Reset controls as shown on the Filter Tuning Sound Chart (Figure 4-3).

OCTAVE = 8'
 REF TONE = F4 = 350 Hz

a) Depress and hold LO F. Zero beat by turning CUTOFF slightly.

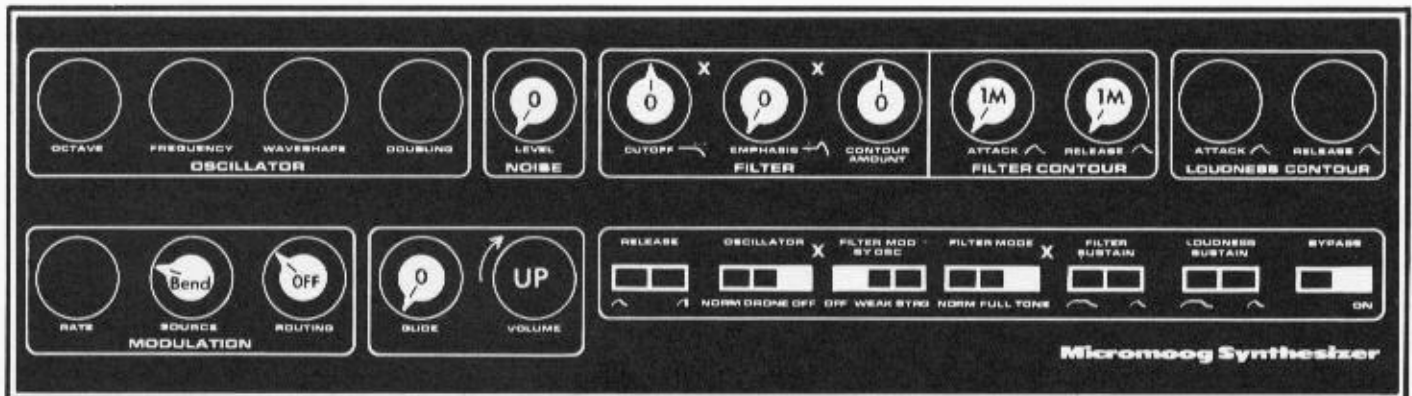

NOTES: Settings of unmarked controls either unimportant (or given in procedure).

- x Set as shown for FILTER SCALE, FILTER LO and FILTER OCTAVE adjustments. Set differently for EMPHASIS adjustments (see procedure).

FIGURE 4-3. FILTER TUNING SOUND CHART

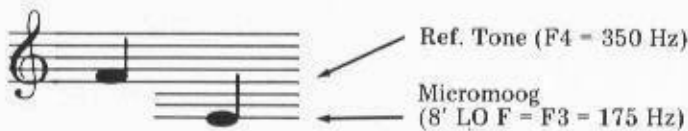

b) Depress and hold MID F (F4) and zero beat with FILTER SCALE trimpot.

4.3.3 FILTER HIGH FREQUENCY COMPENSATION

OCTAVE = 2'

a) Depress and hold LO F. Zero beat using CUTOFF control.

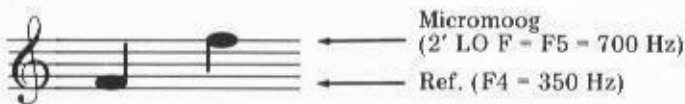

b) Depress and hold MID F. Zero beat using FILTER HI trimpot.

FILTER SCALE and FILTER HI interact a little. Repeat steps 4.3.2 and 4.3.3 once each.

4.3.4 FILTER OCTAVE STEP

OCTAVE = 2'

a) Depress and hold LO F. Zero beat using CUTOFF control.

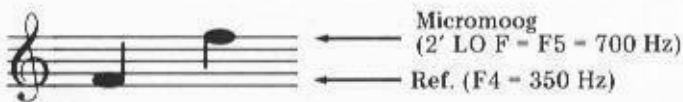

b) Still holding LO F, click oscillator OCTAVE switch to 16'. Adjust FILTER OCT trimpot for zero beats.

Do not expect the filter to be as precisely in tune as the tone oscillator. After all, it is primarily a filter and secondarily a tone source. Beat rates of a few cycles per second are completely normal.

4.4 OTHER ADJUSTMENTS

4.4.1 VCA BALANCE

Set up controls according to Balance and Trim Sound Chart (Figure 4-4).

MODULATION RATE = 30
 MODULATION SOURCE (SELECTOR) = S & H AUTO
 MODULATION ROUTING = OFF
 OSCILLATOR = OFF
 BYPASS (ARTICULATOR) = OFF (NORM)
 VOLUME = 10

Turn up your amp to very high volume. Adjust VCA BAL trimpot for quietest possible sound. (When done, do not forget to turn your amp back down.)

4.4.2 TRILL TRIM

RATE = 3 (ADJUST TO SUIT)
 SOURCE (SELECTOR) =
 ROUTE = OSCILLATOR
 OSCILLATOR = DRONE
 BYPASS (ARTICULATOR) = ON (BYPASS)

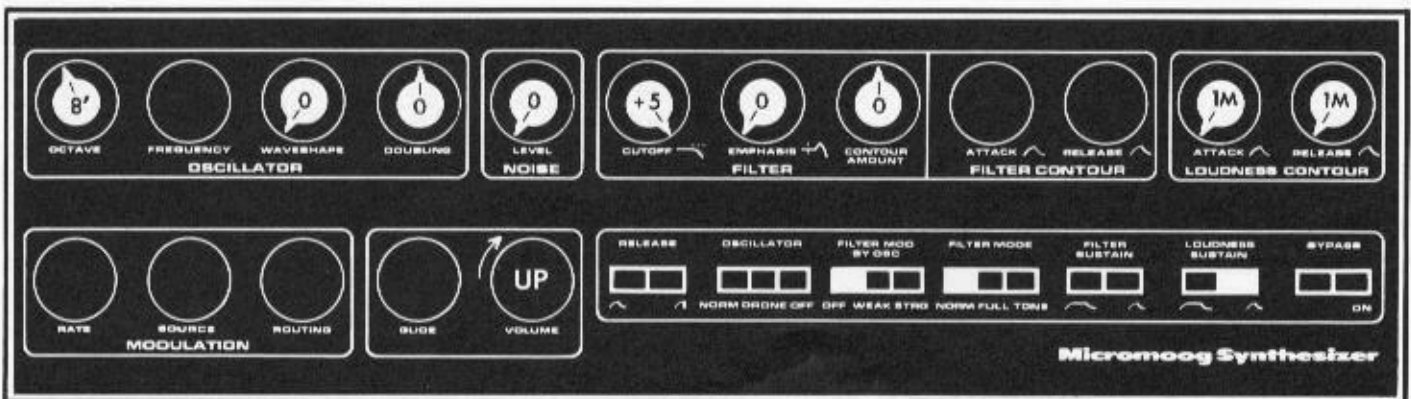

NOTES: Settings of unmarked controls either unimportant (or given in procedure).

FIGURE 4-4 VCA BALANCE & TRILL TRIM SOUND CHART

With MOD AMOUNT wheel fully down, note pitch. Now roll wheel fully forward. You will hear an upward-going trill. The lower note of the trill should remain unchanged. If the lower note moves up or down as the wheel goes up, adjust the TRILL TRIM trimpot so that the pitch remains unchanged. After a few tries, you should be able to set the adjustment perfectly.

4.4.3 RIBBON CENTERING

Set up controls according to Oscillator Tuning Sound Chart (Figure 4-2).

This adjustment aligns the PITCH ribbon so that when you put your finger on the bump on the center of the ribbon, the Micromoog pitch will not change. Listen to the oscillator. Locate the hole in the bottom of the Micromoog under the left hand controller section. Alternately press and release center bump of ribbon. Insert screwdriver and adjust trimpot so that the centering "feels right" for the finger.

4.5 INTERNALLY ACCESSIBLE ADJUSTMENTS

All VCF tuning adjustments are affected by the VCF BAL trimmer. All VCF and VCO tuning adjustments are affected by the -15V and CHIP TEMP trimmers. These 3 trimmers should not be adjusted as part of the routine re-tuning. Note that the knobs are glued in position. These trimpots should be tweaked only when absolutely necessary, i.e., only when a major part in the associated circuit is replaced.

4.5.1 -15V ADJ

Check with DVM. Setting should be $-15.00V \pm 0.01V$. However, if unit can be tuned up without resetting -15V, and -15 is only off slightly, then do not adjust. Maybe your DVM does not match the factory's.

4.5.2 CURRENT SOURCE CHIP TEMPERATURE

Set controls according to Figure 4-2 and use P13/15 as DVM ground.

OSC = NORM

OCT = WIDE

a) Hold LO F and set FREQUENCY control so that V_O (PL13/2) = 0.0000V. Final adjustment may be made using the FINE TUNE control.

Hold HI F and adjust OSC SCALE trimmer for $V_O = 0.0391V (\pm 0.0000V)$.

(This sets the KBD voltage applied to OSC current source transistor to 19.55 mV/octave.)

OCT = 8'

b) Turn on REF OSC (700 Hz = F). Monitor V_E (PL3/1) on DVM.

Insure V_E is stabilized (chip not still heating up).

Depress HI F and use FINE TUNE control to zero beat with REF OSC. Note V_E .

Depress LO F and adjust TEMP trimmer as follows:

If LO F is sharp, decrease V_E .

If LO F is flat, increase V_E .

c) Initially ΔV_E tweaks should be ± 2 mV (± 0.0020). The tweaking will shift the HI F point. So go back to HI F and zero beat again. Then return to LO F and tweak TEMP trimmer. Keep a mental (or written) note of V_E settings. After a couple of repeats (using smaller ΔV_E tweaks as you close in), you should get within ± 1 Hz at LO F. This is close enough. (Allow a few seconds for temperature stabilization after each tweak.)

Glue down the trimpot and never touch again unless you change IC304. You have set the chip to $55^\circ C$ ($131^\circ F$).

4.5.3 FILTER BALANCE

Set controls according to Figure 4-3.

OCTAVE = 4'
STRIKE LO F KEY

Monitor PL3/6. Adjust VCF BAL R514 trimmer so that DC level = $5.00V \pm 0.20V$. Note that it takes several seconds for this level to stabilize. Observe symmetrical sinewave output with no clipping. (If VCF will not oscillate, turn EMPH TRIMMER CCW until it does.)

4.5.4 FILTER RANGE (Not present prior to approximately Serial Number 1250)

Refer to Figure 4-3.

OCTAVE = 4'
AMOUNT = 0 (Check for deadband)
STRIKE LO F KEY

Adjust R381 FILT RNG trimmer for zero beats with 350Hz ref. tone. VCF frequency must be 350Hz, not 700Hz or 175Hz.

4.6 MULTIMOOG OSCILLATOR TUNING PROCEDURE

4.6.1 OSCILLATOR "A" TEMPERATURE ADJUSTMENT

NOTE

This adjustment to be performed only if IC1, A6 or associated components (Top Board 2) is faulty. A 4-1/2 Digit DVM required using PL13/5 as DVM ground.

AB MIX = A
OSC = NORM
OCT = WIDE
INTERNAL = CENTER

a) Monitor V_o at IC1 pin 2 (Q3 base) of Top Board 2. Hold F2 on keyboard and adjust front panel OSCILLATOR FREQUENCY pot for $V_o = 0.0000V$. Final adjustment may be made using FINE TUNE control. Hold F4 and adjust "Oscillator A Scale Trim" R20 (Top Board 2) for $V_o = 0.0391V \pm 0.0000$.

OCTAVE = 8'

b) Turn on Reference Oscillator (700Hz = F). Monitor VE (IC1 pin 3) with DVM. Insure VE is stabilized (chip still not heating up).

c) Depress HI F and zero beat with Reference Oscillator using FINE TUNE control. Note VE.

d) Depress LO F and adjust "Temp Trim" R48 as follows:

If LO F is sharp, decrease VE.
If LO F is flat, increase VE.

e) Initially ΔVE tweaks should be $\pm 2mV (\pm .0020)$. The tweaking will shift the HI F point. So go back to HI F and zero beat again. Then return to LO F and tweak TEMP trimmer. Keep a mental (or written) note of VE settings. After a couple of repeats (using smaller ΔVE tweaks as you close in), you should get within $\pm 1Hz$ at LO F. This is close enough. (Allow a few seconds for temperature stabilization after each tweak.)

"Temp Trim" R48 should not be touched again unless IC1 is changed. The chip is now set to $55^{\circ}C (131^{\circ}F)$.

4.6.2 OSCILLATOR A TUNING

A/B MIX = CENTER
INTERVAL = CENTER

4.6.2.1 SCALE ADJUSTMENT

OCTAVE = 8'

a) Depress F4 and adjust "Oscillator A Range Trim" R24 for zero beat.

b) Depress F1 and adjust "Oscillator A Scale Trim" R20 for zero beat. Repeat if necessary.

4.6.2.2 HI END COMP.

OCTAVE = 2'

a) Depress F1 and adjust "Oscillator A Range Trim" R24 for zero beat.

b) Depress F4 and adjust "Oscillator A Hi Trim" R4 (tandem board 3) for zero beat. Repeat if necessary and check oscillator tracking on all ranges.

4.6.3 INTERVAL TUNING ADJUSTMENT

A/B MIX = CENTER
OCTAVE = 4'

a) Set panel INTERVAL CONTROL to +P5.

b) Depress A note and adjust "Oscillator A Range Trim" R24 to obtain at least a perfect 5th.

c) Return front panel INTERVAL CONTROL to CENTER position.

d) Adjust interval center trim R16 to "Zero Beat Oscillator A With Oscillator B".

e) Check interval control action for unison, +P5, and -P5.

NOTE

If unable to obtain +P5 or -P5, adjust INTERVAL SPAN TRIM R21 to obtain a 14 semitone (Perfect 9th) span from -P5 to +P5 and repeat interval tuning adjustment.

SECTION 5 TROUBLESHOOTING GUIDE

5.1 SOUND CHAIN

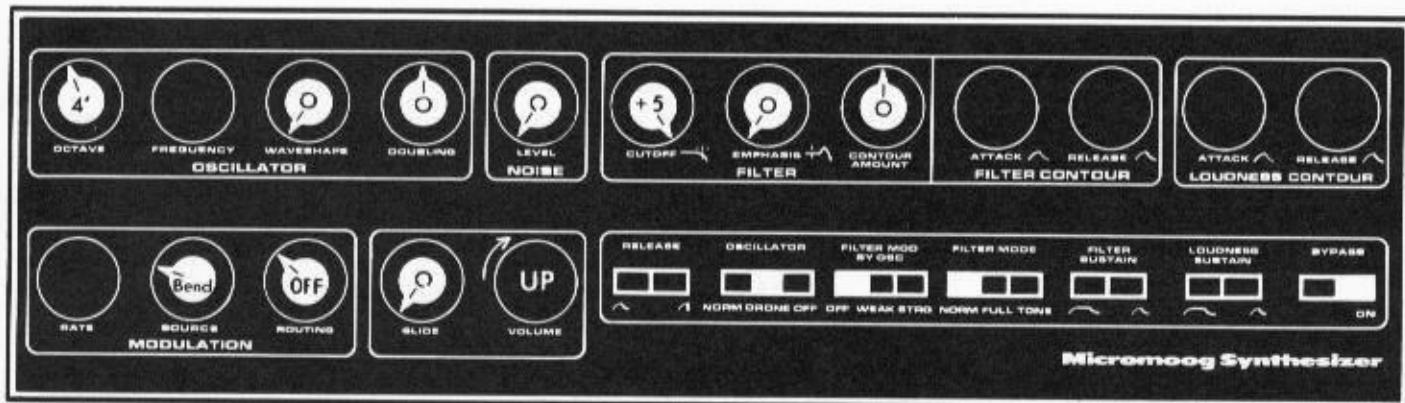

FIGURE 5-1 SOUND CHAIN CHECK

TABLE 5-1
SOUND CHAIN TROUBLESHOOTING GUIDE

SYMPTOM	CORRECTIVE ACTION
<p>A. No Sound. Power Light does not come on.</p>	<ol style="list-style-type: none"> 1. Internal fuse F1 or F2 blown. 2. Bad power supply board 996-041615-001. 3. - 15V shorted out somewhere.
<p>B. No Sound. Power Light on. ± 15V supplies working.</p>	<p>Set controls according to Figure 5-1. Signal trace the following points to locate faulty circuit.</p> <ol style="list-style-type: none"> 1. Q402 Gate 1 to see if the oscillator (VCO) is running. If running: <ol style="list-style-type: none"> a. Roll NOISE control knob up and down. If noise gets through to the output, then the fault lies in the waveshaper circuit. If noise does not get through: b. Check the filter (VCF) output at the emitter of Q513. No output here means that the filter is bad. If our sawtooth is here then: c. Check the output of the VCA at IC602B, pin 7. No signal here indicates trouble in the VCA. Otherwise the problem is in the VOLUME pot R612 or the harness wiring.

TABLE 5-1 (Continued)
SOUND CHAIN TROUBLESHOOTING GUIDE

SYMPTOM	CORRECTIVE ACTION
C. Intermittent Sound. Instrument quits when top of case is pushed down.	1. Main PCB shorting to keyboard. Install continuous grommet (916-041636-001, 17-3/4 inch) across pivot tabs on top of keyboard. See Figure 3-5.
D. VCO not running. Reason undetermined.	1. Short current source IC304, pin 2 (= plug P3/pin 2) to ground. If VCO now runs (about 1.4 kHz), the trouble lies in the oscillator summing network. If the VCO does not run, then the fault lies either in the current source or the VCO itself. 2. Unplug IC304. Run a 1 meg resistor from IC304, pin 1 to -15V. If VCO now runs (about 2 kHz - distorted waveform is normal), your current source is defective. If the VCO does not run, then it is the VCO that is defective.
E. VCO Defective.	1. IC401, IC402, Q401, Q402, CR401. Open R401. Shorted C402.
F. Current Source Defective.	1. IC304, IC303, CR1.
G. Oscillator Summing Network Fault.	1. IC301, CR303, Q307, Q308. 2. One of the summing resistors receiving wrong input. With controls set according to Figure 5-1, VO at P2, pin 3 should be within a few millivolts of -40 mV DC (IC301A, pin 1 should be roughly -2.0 volts DC). If VO is far off spec., then check input ends of R302, 330, 331, 339, 343, 371 and 372. You may short each one of these resistors to ground to help locate the troublesome input.
H. Defective Waveshaper.	Monitor waveshaped output at IC403B, pin 7. Roll WAVESHAPE pot from CCW to CW. 1. Sawtooth present but no pulse: Schmitt consisting of Q404 and Q405 not working. Double check Q405 collector. 2. Pulse present but no sawtooth: Q403 not functioning. 3. No output (or non-changing output): IC403 defective.
I. VCF not passing signal. Reason undetermined.	Set controls according to Figure 5-1. 1. Insure that input signal of roughly 40 mV p-p appears at base of Q501.

TABLE 5-1 (Continued)
SOUND CHAIN TROUBLESHOOTING GUIDE

SYMPTOM	CORRECTIVE ACTION
<p>I. VCF not passing signal. Reason undetermined. (Continued)</p>	<p>2. This same waveform should appear (40 mV p-p differentially) at top of ladder across emitters of Q509 and Q510. If signal is present here, then problem lies in the gain recovery amp (Q514, IC501, Q512 or Q513). If signal is not present here:</p> <ul style="list-style-type: none"> a. Check V_F at P3/4. It should be about + 80 mV DC \pm 25 mV. If it is far off spec. (i.e., negative instead of positive), the filter will be perpetually shut down. The defect is in the VCF summing network. If V_F is correct, then: b. Remove IC304 from socket. Short socket pin 14 to ground. If filter now passes the input signal, the current source is faulty (see Step F). If it does not, then the ladder itself is defective.
<p>J. VCF Summing Network Fault.</p>	<ul style="list-style-type: none"> 1. IC302, Q309, Q310. 2. Wrong input to a summing resistor. Check input ends of R313, R314, R316, R317, R322, R318, R323, R374 and R375.
<p>K. VCF Ladder Faulty.</p>	<ul style="list-style-type: none"> 1. Check DC bias voltages (see Figure 6-3). 2. Check for emitter-to-emitter DC voltage balance within 100 mV for pairs Q503 - 504; Q505 - 506; and Q507 - 508. Replace off-tolerance pairs. 3. Replace IC502. If VCF still will not run, then: <ul style="list-style-type: none"> a. Replace Q503, 504, 505, 506, 507, 508 all at once (all pairs not replaced in step 2 of K). b. Replace capacitors C501 thru C504.
<p>L. VCA not working.</p>	<ul style="list-style-type: none"> 1. Insure that IC601, pin 2 has 40 mV p-p signal. (See Figure 5-1.) If signal is here, VCA is at fault. 2. Possible defective parts: IC601, IC602, Q601, SW601.

5.2 PITCH DRIFT AND TUNING

5.2.1 OSCILLATOR DRIFT

Be careful about complaints of pitch drift. Owners tend to call almost any pitch inaccuracy problem "oscillator drift". For example:

1. Mistuning due to normal component aging or to improper adjustment.
2. Unit not tunable (even temporarily).
3. Normal oscillator warm-up after turn-on (thermostatted IC304 requires a couple of minutes to reach operating temperature).
4. Mis-adjusted OCTAVE switch.
5. Keyboard drift (pitch drift after key release).
6. Slight deviations of a few cents from the equally-tempered scale (normal).

None of these conditions constitutes oscillator drift. Drift refers only to unstable tuning (the unit will not stay in tune once adjusted properly).

There are two types of oscillator drift — range drift and scale drift. Range drift means that all pitch intervals remain correct but that the pitch of all the keys goes up or down. For example, the interval

from LO F to HI F on the keyboard may remain exactly two octaves but after a few hours the F keys may actually sound F # instead of F, etc. Scale drift means that the pitch intervals are changing. For example, the interval from LO F to HI F might be perfectly in tune at first but be a semitone flat a few hours later. Scale drift is a much more serious fault. Slow range drift is a minor inconvenience (the FINE TUNE control may have to be tweaked from time to time) whereas slow scale drift renders the instrument practically useless for live performance.

Normally we expect that the Micromoog range will require adjustment only once at the start of a given performance (via the rear panel FINE TUNE control knob). The scale trimpot adjustment should need tweaking rather infrequently — several times a year at the most.

5.2.2 OSCILLATOR AND FILTER

In the following guide we assume that either we can not bring the instrument in tune within the specifications given in the adjustment procedure or that the instrument can be brought in tune but will not stay in tune.

TABLE 5-2
OSCILLATOR AND FILTER TROUBLESHOOTING GUIDE

PROBLEM	CAUSE
A. Oscillator High End (Octave = 2') Tuning.	Faulty R401 OSC HI trimpot. Faulty IC304.
B. Oscillator Scale.	Faulty IC304 or IC303. Leaky Q307 or Q308. - 15V power supply drift. Faulty R359 TEMP or R331 OSC SCALE trimpots.
C. Oscillator Range. (Oscillator = Drone)	Faulty R337 OSC RNG trimpot. IC303, IC304, IC301, Q307, Q308. Shorted ribbon (pitch off about a fifth).
D. Oscillator LO End (Octave = 32')	Leaky Q401, Q402, C401, IC304.
E. Filter HI End (700 Hz F to 1400 Hz F)	Faulty R357 FILTER HI trimpot. R708 shorted to underlying trace.

TABLE 5-2 (Continued)
OSCILLATOR AND FILTER TROUBLESHOOTING GUIDE

PROBLEM	CAUSE
F. Filter Scale	IC304, IC303, Q309, Q310. Faulty R321 FILTER SCALE trimpot. SW501 FILT MODE control switch.
G. Filter Range	IC302, IC303, IC304, Q309, Q310. R381 FILT RNG trimpot. R320 CUTOFF control pot.
H. Filter LO End (44 Hz F to 176 Hz F)	Leaky Q514, IC502 or IC304.
I. Oscillator (and Filter) Drift when Key Released. (More than one semitone/min.)	Keyboard drift. Oscillator and/or filter not at fault.

NOTE

The filter and oscillator should always be completely retuned whenever any part mentioned above is replaced. But do not retune R359 TEMP trimpot unless either IC304 or R359 is replaced. R359 should never be adjusted unless absolutely necessary. If you have swapped or removed IC304 in the course of troubleshooting, put the original 3046 back in the socket if it is found to be not at fault.

5.3 KEYBOARD

5.3.1 CLEANING KEY CONTACTS

Normally this is not a necessary maintenance procedure. However, if dirty contacts have become a problem, do not spray contact cleaner onto the key contacts. The spray may gum up the rubber keystone bumpers and other mechanical parts. Dirty contacts should be cleaned with a cotton swab dipped in rubbing alcohol (iso-propanol). Common "contact cleaners" should be strictly avoided. Never use emery paper, burnishing tools or other abrasives on either the buss bar or the contact wires ("J-wires")

since this will remove the gold plating from these parts. Stubborn dirt or corrosion build-up may be removed with a non-abrasive typewriter eraser. Some people claim that Cramolin-R spray applied sparingly with a cotton swab is a great cure-all. People who use this technique should be prepared to periodically re-clean contacts since Cramolin-R leaves a protective film that will eventually collect dust and cause contacting problems. Cramolin is your only solution if someone has filed the gold off the J-wires. If the buss bar has the gold removed from the contact area, the buss bar may be rotated so that the J-wire contacts its good side. Do not touch J-wires or buss bar with the fingers. Oily fingerprints on the contact area will cause corrosion and intermittent operation.

TABLE 5-3
KEYBOARD TROUBLESHOOTING GUIDE

SYMPTOM	CORRECTIVE ACTION
A. HI C or LO F Key sticks down.	1. Loose keyboard has shifted to one side. Shift keyboard back to right or left and tighten mounting screws very hard. Cup washer 904-040948-006 installed under the four mounting screw heads will prevent re-occurrence of the problem. See Figure 3-8.
B. Keyboard mounting screws pulled through base.	1. Install an 904-040948-006 cup washer under each of the four mounting screws. See Figure 3-8.
C. Keyboard does not work. Oscillator sounds only LO F. Trigger always on.	1. Hold down LO F key. If other keys now work normally, it means the lowest keyboard J-wire is on the wrong side of the buss bar. Reposition contact wire so that is normally resides above buss bar. See Figure 3-14.
D. Released keys spring up and hit case.	1. File lip of case above keys to increase clearance.
E. Retriggering when key is released (called "Double Triggering").	1. Contact(s) set to "Make" too soon as key travels downward. Contact should occur when key tip has traveled downward $1/4'' \pm 1/16''$ ($3/16'' + 1/16''$ for black keys), gently bend J-wires with long nose pliers. Make bends only when key is in normal UP position. See Figure 3-9.
F. Multiple triggering or "Gritchy" sound as key goes down.	1. Dirty switch contacts. Clean. See Figure 3-9.
G. Keyboard Drift.	1. C212 or Q201 leaky. 2. Solder flux, dust, contact cleaner or some other foreign matter on PC board in region of GLIDE pot R251. 3. Broken guard trace on main PC board.
H. No trigger from Keyboard. Ext. S-Trig correct.	1. IC201, IC202, IC203.
I. No Ext. S-Trig and No KBD S-Trig.	1. SW801 open contact. 2. Contour generator faulty.
J. No Ext S-Trig. KBD Trig correct.	1. IC204.
K. No control voltage and no trigger from KBD.	1. IC202. 2. Open or shorted harness wire or connector. 3. Defective keyboard assembly.
L. No control voltage but KBD trigger correct.	1. GLIDE pot R251 open. 2. Shorted C212, CR203, CR204. 3. IC204A, Q201 defective.

**TABLE 5-4
POTS AND SWITCHES TROUBLESHOOTING GUIDE**

SYMPTOM	CORRECTIVE ACTION
A. Intermittent or Noisy Pots and Switches.	<ol style="list-style-type: none"> 1. Dirty pot element. Spray lightly with Cramolin-R[®] or TV tuner cleaner. Avoid spraying GLIDE pot R251. 2. Defective or worn wiper or element. Replace pot.
B. Intermittent or Unstable Trimpot.	<ol style="list-style-type: none"> 1. Dirty element. Spray with Cramolin-R[®] or TV tuner cleaner. 2. Loose knob (turns quite freely). Replace trimpot. 3. Worn or defective wiper or element, cracked internal connection. Replace.
C. Nowhere in Region of DOUBLING = 0 will doubling completely disappear. (Doubling Bleed thru)	<ol style="list-style-type: none"> 1. R435 DOUBLING control pot (925-040263-001) has insufficient deadband at 50% rotation. Replace pot.
D. Nowhere in Region of CONTOUR AMOUNT = 0 will Filter Contour completely disappear.	<ol style="list-style-type: none"> 1. R715 CONTOUR AMOUNT control pot (925-040263-001) has insufficient deadband at 50% rotation. Replace pot.
E. Intermittent MOD AMOUNT wheel. Non-smooth action of wheel.	<ol style="list-style-type: none"> 1. Old style CTS 550 Pot (28-039 Rev. B) installed. Replace with new style CTS 450 Pot (925-040269-001).
F. Modulation Bleed thru when MOD AMOUNT wheel fully down.	<ol style="list-style-type: none"> 1. Wheel mis-adjusted on pot shaft. Reposition so that 6 Hz vibrato (A routed to OSC) just becomes indiscernable when wheel fully down. Adjust with left hand control assembly mounted in case.
G. Noise Source Bleed thru when Noise LEVEL = 0.	<ol style="list-style-type: none"> 1. R905 noise LEVEL control pot (925-040262-006) end resistance too high. Replace pot.

TABLE 5-5
CONTROL CIRCUITS TROUBLESHOOTING GUIDE

SYMPTOM	CORRECTIVE ACTION
A. Neither Contour Generator works correctly.	<ol style="list-style-type: none"> 1. Timer IC701 faulty. 2. Faulty Trigger Input Chain Q801, Q701, Q702.
B. Filter Contour Faulty. Loudness satisfactory.	<ol style="list-style-type: none"> 1. IC701, IC702, C706, Q703, CR702, CR706, SW703 FILT. SUST, R708 filt. ATTACK, R709 filt. DECAY, R715 CONTOUR AMOUNT.
C. Loudness Contour Faulty. Filter satisfactory.	<ol style="list-style-type: none"> 1. IC701, IC602, C705, Q601, CR701, CR705, SW601 BYPASS, SW701 LOUDNESS SUSTAIN, R704 loudness ATTACK, R705 loudness DECAY.
D. No Modulation Control Voltage (Bend, Noise, \square , Δ , S & H Auto, S & H KBD All Dead).	<ol style="list-style-type: none"> 1. IC801, open or shorted harness wire or connector, J7 MODULATION jack, R1007 MOD AMOUNT pot, SW801 SOURCE switch.
E. Only Noise and Bend Modulation Modes work.	<ol style="list-style-type: none"> 1. IC801.
F. Excessive S & H Drift.	<ol style="list-style-type: none"> 1. If drift ceases when IC902 is pulled out of socket, IC902 is leaky and must be replaced. Otherwise: 2. Leaky Q901 or C908.
G. S & H Output not changing. Other Modulation Sources satisfactory.	<ol style="list-style-type: none"> 1. No trigger pulse via CR902. 2. No noise input via R906. 3. Dead IC902 or Q901. Shorted C908.
H. Loud Thumps or Clicks at Mod Rate in Audio Output.	<ol style="list-style-type: none"> 1. R606 VCA BAL trimpot mis-adjusted.
I. No Noise Output.	<ol style="list-style-type: none"> 1. R905, IC901.
J. Ribbon Warbles when touched.	<ol style="list-style-type: none"> 1. Faulty ground to bezel. 2. Is grounding screw head making good contact with bezel?
K. Top Surface of Ribbon Abraded.	<ol style="list-style-type: none"> 1. Apply new layer of glass-teflon tape (933-041678-001, 4-1/2 inch) atop original layer or replace ribbon assembly (997-040525-001).
L. Ribbon "Dead" or Ribbon does not return to center.	<ol style="list-style-type: none"> 1. Ribbon contact strip warped and shorted. 2. Replace ribbon assembly (997-040525-001). (Ribbon assembly generally not repairable.)

**TABLE 5-7
NOISE, ETC. TROUBLESHOOTING GUIDE**

SYMPTOM	CORRECTIVE ACTION
A. Audio Bleed thru when VOLUME = 0, OSCILLATOR = Off, and BYPASS = Off.	1. For units previous to roughly S/N 3300, add modification kit for direct shielded cable to audio output jack J2.
B. Crackles in Audio Output.	1. Noisy transistor or IC in VCF - VCA sound chain. Probably IC501 or IC601.
C. Audible Distortion, Clipping - especially at Low Frequency.	1. VCF or VCA out of balance. Probably mis-adjusted R514 VCF BAL or R606 VCA BAL trimpot.
D. In certain metropolitan locations: Mysterious Pitch Instability, Noise, Hum, Bleed thru, "Crazy" Operation, Radio or Television Pickup.	1. Several of these symptoms may show up simultaneously. The Micromoog is quite insensitive to radio/television transmitter pickup. However if a powerful station transmitter is within a block or two, the problem may occur. If the RFI field is so strong the Micromoog is affected, your other equipment (amps, mixers) will probably be affected also.

*MICROMOOG/MULTIMOOG POWER SUPPLY PRINTED CIRCUIT BOARD
REPLACEMENT PARTS LIST*

INDEX NO. OR REF DESIG	PART NUMBER	DESCRIPTION	QTY
	996-041615-001	Printed Circuit Board Assembly consisting of:	
C101,C102	945-040209-007	Capacitor, 470uf, 35V	2
C103,C104	947-040194-152	Capacitor, 1500Pf	2
C105,C106	946-040231-004	Capacitor, 6.8uf, 20V, ± 10%	2
CR101 thru CR106	919-040219-001	Diode, Rectifier, 1N4004	6
IC101	991-041111-001	Integrated Circuit, ± 15 VDC Reg, SG1468	1
P5	910-042531-009	Connector, Printed Circuit Board, 9 Pin Straight, AMP640445-1 ..	1
P6	910-041716-003	Header, Printed Circuit Board, 3 Pin, AMP350210-1	1
Q101	991-041050-001	Transistor, PNP, TIP30	1
Q102	991-041049-001	Transistor, NPN, TIP29	1
R101,R102	852-312470-001	Resistor, 47 Ohm, ± 5%, 1/4W	2
R103,R104	852-312024-001	Resistor, 2.4 Ohm, ± 5%, 1/4W	2
R105,R107	853-424531-031	Resistor, 4.53K Ohm, ± 1%, 1/4W	2
R106	925-040281-002	Resistor, Cermet Trim, 2K Ohm	1
	816-040039-006	Screw, Self Tapping, No. 6B x 3/8 in.	2
	902-042525-001	Nut, Speed, Type W, Tinnerman, No. C224-6Z-4	2
	967-040935-001	Heat Sink, IERC PA1-1CB	2
	980-040867-001	Printed Circuit Board	1

SECTION 6 REPLACEMENT PARTS LIST

997-0414759-01

MICROMOOG/MULTIMOOG MAIN PRINTED CIRCUIT BOARD ASSEMBLY REPLACEMENT PARTS LIST

A = MICROMOOG, B = MULTIMOOG, A,B = BOTH

NOTE: THIS SECTION ALSO CONTAINS MULTIMOOG CIRCUIT DESCRIPTION AND SCHEMATIC DIAGRAMS

INDEX NO. OR REF DESIG	PART NUMBER	CODE	DESCRIPTION	QTY
C109,C110,C402	996-041474-001	A	Micromoog Printed Circuit Board Assembly	
	996-041474-002	B	Multimoog Printed Circuit Board Assembly	
C201,C204, C206,C408	946-040231-001	A,B	Capacitor, Tantalum, 1.5uf, 20V	3
C202,C203,C208, C209,C214,C303, C310,C403,C404, C409,C509,C510, C602,C603,C702, thru C704,C803, C906,C907	947-042020-102	A,B	Capacitor, Disc, 0.001uf	4
C207,C405,C406 C210,C412, C902,C905	947-040200-103	A,B	Capacitor, Disc, 0.01uf	20
C211,C213,C307, C410,C605,C901	947-042020-300	A,B	Capacitor, Disc, 30Pf	3
C212	946-041978-224	A,B	Capacitor, Polyester, 0.22uf	4
C215	946-041978-104	A,B	Capacitor, Polyester, 0.1uf.	6
C301,C302,C309, C407,C505,C508, C604,C606,C701, C802,C804	946-040227-001	A,B	Capacitor, Polycarbonate, 0.27uf, 50V, ±20%	1
C311	946-041978-102	A,B	Capacitor, Polyester, 0.001uf	1
C401	947-042020-101	A,B	Capacitor, Disc, 100Pf	11
C501 thru C504, C909	947-040200-103	B	Capacitor, Disc, 0.01uf	1
C506	946-042021-102	A,B	Capacitor, Polystyrene, 0.001uf, 600V, ±5%.	1
C507,C513	946-041978-333	A,B	Capacitor, Polyester, 0.033uf	5
C514,C601	945-040209-006	A,B	Capacitor, Alum., Elect., 0.47uf, 50V	1
C705,C706	945-040209-003	A,B	Capacitor, Alum., Elect., 200uf, 6V	2
C707	945-040209-005	A,B	Capacitor, Alum., Elect., 2.2uf, 50V	2
C801	946-040231-004	A,B	Capacitor, Tantalum, 6.8uf, 20V	2
C903	945-040209-004	A,B	Capacitor, Alum., Elect., 400uf, 16V	1
C904	946-040231-003	A,B	Capacitor, Tantalum, 2.7uf, 35V	1
C908	946-041978-683	A,B	Capacitor, Polyester, 0.068uf	1
CR201,CR205	946-041978-153	A,B	Capacitor, Polyester, 0.015uf	1
CR202,CR206,CR207, CR301 thru CR303, CR401 thru CR404, CR703,CR704,CR706, CR901	946-041978-474	A,B	Capacitor, Polyester, 0.47uf	1
	919-041074-001	A,B	Diode, Germanium, 1N34A	2
	919-042894-001	A,B	Diode, FET, Modified 2N4303	14

MICROMOOG/MULTIMOOG MAIN PRINTED CIRCUIT BOARD ASSEMBLY

REPLACEMENT PARTS LIST (Continued)

A = MICROMOOG, B = MULTIMOOG, A,B = BOTH

INDEX NO. OR REF DESIG	PART NUMBER	CODE	DESCRIPTION	QTY
CR203,CR204,CR601, CR602,CR701,CR702, CR705,CR801,CR802	919-042019-001	A,B	Diode, Rectifier, 1N4004	9
CR208	919-042019-001	B	Diode, Rectifier, 1N4004	1
IC201,IC203,IC402, IC501,IC601,IC902	991-041089-003	A,B	Integrated Circuit, Operational Amplifier, LM3080 Selected	6
IC202,IC204,IC301 thru IC303,IC401, IC403,IC602,IC702, IC801	991-041102-001	A,B	Integrated Circuit, Dual Operational Amplifier, MC1458CP-1	10
IC205	949-040854-001	A,B	Integrated Keyboard Circuit, CTS, Series 750 . . .	1
IC304,IC502	991-041104-001	A,B	Integrated Circuit, Transistor Array, CA3046 . . .	2
IC305	949-040843-001	A,B	Integrated Circuit, Octave Buffer Resistor Package, CTS Series 750	1
IC306	949-040845-001	A,B	Integrated Circuit, Oscillator Summer Resistor Package, CTS Series 750	1
IC307	949-040844-001	A,B	Integrated Circuit, Filter Summer Resistor Package, CTS Series 750	1
IC308	949-040847-001	A,B	Integrated Circuit, Inverter Resistor Package, CTS Series 750	1
IC309	949-040851-001	A,B	Integrated Circuit, Routing Resistor Package, CTS Series 750	1
IC404	991-041110-001	A,B	Integrated Circuit, CMOS, CD4013, Alternate 5613	1
IC405	949-040849-001	A,B	Integrated Circuit, Oscillator No. 1 Resistor Package, CTS Series 750	1
IC406	949-040846-001	A,B	Integrated Circuit, Waveshape No. 1 Resistor Package, CTS Series 750	1
IC407	949-040848-001	A,B	Integrated Circuit, Waveshape No. 2 Resistor Package, CTS Series 750	1
IC408	949-040850-001	A,B	Integrated Circuit, Oscillator No. 2 Resistor Package, CTS Series 750	1
IC503	949-040918-001	A,B	Integrated Circuit, 1K Cer Resistor Package, CTS Series 760	1
IC701	949-041109-001	A,B	Integrated Circuit, Dual Timer, 556	1
IC703	949-040853-001	A,B	Integrated Circuit, Contour Generator Resistor Package, CTS Series 750	1
IC704	949-040852-001	A,B	Integrated Circuit, Contour Amount Resistor Package, CTS Series 750	1
IC901	991-042016-001	A,B	Integrated Circuit, Noise Generator, MOS, 5837 . .	1
P1,P3	910-042532-006	A,B	Header, Printed Circuit Board, 6 Pin, Right Angle, AMP640389-6	2
P2,P4	910-042352-009	A,B	Header, Printed Circuit Board, 9 Pin, AMP640389-9	2
Q201,Q402,Q514	991-041054-001	A,B	Transistor, Dual FET, E402	3
Q202	991-042548-001	B	Transistor, N Channel FET, E212	1
Q306,Q601	991-041052-001	A,B	Transistor, PNP, 2N3906	2

MICROMOOG/MULTIMOOG MAIN PRINTED CIRCUIT BOARD ASSEMBLY

REPLACEMENT PARTS LIST (Continued)

A = MICROMOOG, B = MULTIMOOG, A,B = BOTH

INDEX NO. OR REF DESIG	PART NUMBER	CODE	DESCRIPTION	QTY
Q307 thru Q310, Q403 thru Q406, Q503 thru Q513, Q701 thru Q703, Q801	991-042017-001	A,B	Transistor, NPN, 2N3392	23
Q401,Q901	991-041055-001	A,B	Transistor, N Channel FET, E112	2
R236,R264,R365	852-312105-001	A,B	Resistor, 1 Megohm, $\pm 5\%$, 1/4W	3
R239,R369	852-312221-001	A,B	Resistor, 220 Ohm, $\pm 5\%$, 1/4W	2
R240,R245,R366, R368,R527,R611	852-312102-001	A,B	Resistor, 1K Ohm, $\pm 5\%$, 1/4W	6
R241,R242,R325, R345,R362,R504, R722,R804,R809, R907,R912	852-312103-001	A,B	Resistor, 10K Ohm, $\pm 5\%$, 1/4W	11
R243,R322,R517, R518,R607,R908	852-312333-001	A,B	Resistor, 33K Ohm, $\pm 5\%$, 1/4W	6
R244	852-312473-001	A,B	Resistor, 47K Ohm, $\pm 5\%$, 1/4W	1
R246,R249,R252 thru R254,R256, R323,R515,R516, R605,R805,R806	852-312104-001	A,B	Resistor, 100K Ohm, $\pm 5\%$, 1/4W	12
R247,R364	851-152156-000	A,B	Resistor, 15 Megohm, $\pm 10\%$, 1/4W	2
R248	852-512685-001	A,B	Resistor, 6.8 Megohm, $\pm 5\%$, 1/2W	1
R250	852-312152-001	A,B	Resistor, 1.5K Ohm, $\pm 5\%$, 1/4W	1
R251	925-042550-007	A,B	Resistor, Rotary, Audio, 5 Megohm	1
R255	852-312684-001	A,B	Resistor, 680K Ohm, $\pm 5\%$, 1/4W	1
R257,R262,R326, R350,R377 thru R379,R501,R505, R522,R811,R812, R814,R906,R909	852-312472-001	A,B	Resistor, 4.7K Ohm, $\pm 5\%$, 1/4W	15
R263	851-152106-000	B	Resistor, 22 Megohm, $\pm 10\%$, 1/4W	1
R265	853-422553-031	B	Resistor, 255K Ohm, $\pm 1\%$, 1/4W	1
R266	853-422373-031	B	Resistor, 237K Ohm, $\pm 1\%$, 1/4W	1
R267	925-042526-004	B	Resistor, Trim Pot, 25K Ohm	1
R301,R320	925-042550-002	A,B	Resistor, Rotary, Linear, 10K Ohm	2
R305	852-312242-001	A,B	Resistor, 2.4K Ohm, $\pm 5\%$, 1/4W	1
R311,R321, R329,R514	925-042526-004	A,B	Resistor, Trim Pot, 25K Ohm	4
R328	852-312471-001	A,B	Resistor, 470 Ohm, $\pm 5\%$, 1/4W	1
R331	925-042526-003	A,B	Resistor, Trim Pot, 10K Ohm	1
R334	852-512475-001	A,B	Resistor, 4.7 Megohm, $\pm 5\%$, 1/2W	1
R337,R381, R606,R816	925-042526-005	A,B	Resistor, Trim Pot, 100K Ohm	4
R341	852-512106-001	A,B	Resistor, 10 Megohm, $\pm 5\%$, 1/2W	1

MICROMOOG/MULTIMOOG MAIN PRINTED CIRCUIT BOARD ASSEMBLY

REPLACEMENT PARTS LIST (Continued)

A = MICROMOOG, B = MULTIMOOG, A,B = BOTH

INDEX NO. OR REF DESIG	PART NUMBER	CODE	DESCRIPTION	QTY
R349,R355	853-421000-031	A,B	Resistor, 100 Ohm, $\pm 1\%$, 1/4W	2
R353,R356,R376, R521,R813,R903	852-312222-001	A,B	Resistor, 2.2K Ohm, $\pm 5\%$, 1/4W	6
R357	925-042526-002	A,B	Resistor, Trim Pot, 5K Ohm	1
R358	853-423321-031	A,B	Resistor, 3.32K Ohm, $\pm 1\%$, 1/4W	1
R359	925-042526-001	A,B	Resistor, Trim Pot, 1K Ohm	1
R360	853-421003-031	A,B	Resistor, 100K Ohm, $\pm 1\%$, 1/4W	1
R361,R523	852-312332-001	A,B	Resistor, 3.3K Ohm, $\pm 5\%$, 1/4W	2
R363	853-421004-031	A,B	Resistor, 1 Megohm, $\pm 1\%$, 1/4W	1
R367	852-312682-001	A,B	Resistor, 6.8K Ohm, $\pm 5\%$, 1/4W	1
R370	852-312101-001	A,B	Resistor, 100 Ohm, $\pm 5\%$, 1/4W	1
R380	852-312155-001	A,B	Resistor, 1.5 Megohm, $\pm 5\%$, 1/4W	1
R382	852-312223-001	B	Resistor, 22K Ohm, $\pm 5\%$, 1/4W	1
R439	852-312515-001	A,B	Resistor, 5.1 Megohm, $\pm 5\%$, 1/4W	1
R502	852-312223-001	A	Resistor, 22K Ohm, $\pm 5\%$, 1/4W	1
R503,R519,R608 thru R610,R802,	852-312223-001	A,B	Resistor, 22K Ohm, $\pm 5\%$, 1/4W	8
R902,R913	852-312621-001	A,B	Resistor, 620 Ohm, $\pm 5\%$, 1/4W	1
R513	852-312621-001	A,B	Resistor, 620 Ohm, $\pm 5\%$, 1/4W	1
R524	852-312331-001	A,B	Resistor, 330 Ohm, $\pm 5\%$, 1/4W	1
R525	925-042550-003	A,B	Resistor, Rotary, Rev. Audio, 50K Ohm	1
R526	925-042526-001	A,B	Resistor, Trim Pot, 1K Ohm	1
R601	852-312392-001	A,B	Resistor, 3.9K Ohm, $\pm 5\%$, 1/4W	1
R603,R604	852-312470-001	A,B	Resistor, 47 Ohm, $\pm 5\%$, 1/4W	2
R721	852-312273-001	B	Resistor, 27K Ohm, $\pm 5\%$, 1/4W	1
R801	925-042550-005	A,B	Resistor, Rotary, Rev. Audio, 2.5 Megohm	1
R803	852-312753-001	A,B	Resistor, 75K Ohm, $\pm 5\%$, 1/4W	1
R807	852-312622-001	A,B	Resistor, 6.2K Ohm, $\pm 5\%$, 1/4W	1
R808,R911	852-312473-001	A,B	Resistor, 47K Ohm, $\pm 5\%$, 1/4W	2
R815,R901	852-312100-001	A,B	Resistor, 10 Ohm, $\pm 5\%$, 1/4W	2
R905	925-042550-006	A,B	Resistor, Rotary, Linear, 20K Ohm	1
R910	852-312224-001	A,B	Resistor, 220K Ohm, $\pm 5\%$, 1/4W	1
SW301,SW801, SW802	960-041754-001	A,B	Switch, Rotary, 2P6T, CTS 32704	3
SW302,SW303	960-041752-001	A,B	Switch, Slide, 2P3T, UID	2
SW501	960-041753-001	A,B	Switch, Slide, 3P3T, UID	1
SW601,SW701 thru SW703	960-041751-001	A,B	Switch, Slide, 2P2T, UID	4
	906-040307-007	A,B	Integrated Circuit Socket, SIL, 7 Pin, AMP1-583773-4	6
	906-042012-008	A,B	Integrated Circuit Socket, DIP, 8 Pin, AMP583640	1
	910-040310-001	B	Pin, Printed Circuit Board, 0.058, AMP60973-1	8
	980-040939-002	A,B	Printed Circuit Board	1

EXT. AUDIO
LIP

WAVE SHAPE

VOI TAOS-BLEST

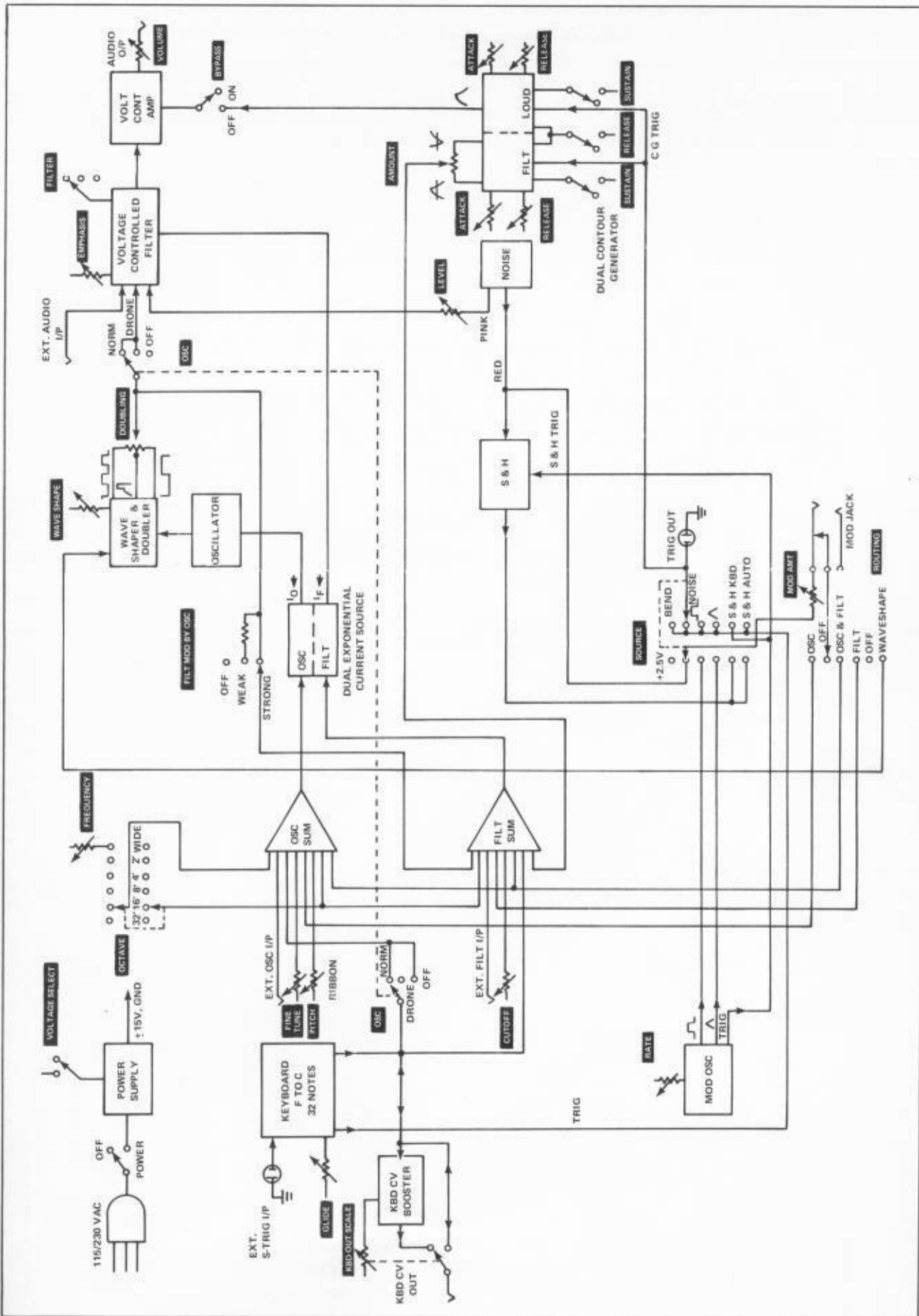

FIGURE 6-1 MICROMOG BLOCK DIAGRAM

**MULTIMOOG TANDEM PRINTED CIRCUIT BOARD
REPLACEMENT PARTS LIST**

INDEX NO. OR REF DESIG	PART NUMBER	DESCRIPTION	QTY
	996-042415-001	Printed Circuit Board Assembly consisting of:	
A1,A3 thru A5, A8	991-041102-001	Integrated Circuit, Dual Operational Amplifier, MC1458CP-1	5
A2,A6	991-041089-004	Integrated Circuit, Operational Amplifier, LM3080AN	2
A7	991-041210-002	Integrated Circuit, Operational Amplifier, CA3094AE	1
C1,C18,C19	946-040231-001	Capacitor, Tantalum, 1.5uf, 20V	3
C2	946-041978-104	Capacitor, Polyester, 0.1uf	1
C3,C9	946-042021-102	Capacitor, Polystyrene, 0.001uf	2
C4,C10,C22,C23	947-042020-101	Capacitor, Disc, 100Pf	4
C5,C6	947-042020-300	Capacitor, Disc, 30Pf	2
C7,C8,C12, C15,C16,C20, C24 thru C26	947-040200-103	Capacitor, Disc, 0.01uf	9
C11	946-040231-002	Capacitor, Tantalum, 10uf, 20V	1
C13	946-041978-473	Capacitor, Tantalum, 0.047uf	1
C14	946-041978-823	Capacitor, Polyester, 0.082uf	1
C17	946-041978-105	Capacitor, Polyester, 1uf	1
C21	947-040209-005	Capacitor, Alum., Elect., 2.2uf, 50V	1
CR1 thru CR3, CR6 thru CR8	919-041075-001	Diode, 1N4148, Alternate 1N914	6
CR4,CR5	919-042019-001	Diode, Rectifier, 1N4004	2
CR9	919-042233-001	Diode, STB568	1
IC1	991-041088-001	Integrated Circuit, CD4011AE	1
N1	949-040849-001	Resistor Network, Oscillator No. 1	1
N2	949-040850-001	Resistor Network, Oscillator No. 2	1
N3	949-042426-001	Resistor Network, Waveshape No. 1	1
N4	949-040848-001	Resistor Network, Waveshape No. 2	1
P1,P2,P4	910-042532-006	Header, Printed Circuit Board, Right Angle, 6 Pin, AMP640389-6 . .	3
P3	910-042532-009	Header, Printed Circuit Board, Right Angle, 9 Pin, AMP640389-9 . .	1
Q1	991-041055-001	Transistor, N Channel FET, E112	1
Q2	991-041054-001	Transistor, Dual FET, E402	1
Q3 thru Q5	991-042017-001	Transistor, NPN, 2N3392	3
Q6,Q8	991-041052-001	Transistor, PNP, 2N3906	2
Q7	991-041064-001	Transistor, 2N4303	1
Q9	991-041051-001	Transistor, NPN, 2N3904	1
R4	925-042526-003	Resistor, Trim Pot, 10K Ohm	1
R5	852-312222-001	Resistor, 2.2K Ohm, $\pm 5\%$, 1/4W	1
R6,R17,R18, R43,R45,R46, R58,R62,R64, R68	852-312104-001	Resistor, 100K Ohm, $\pm 5\%$, 1/4W	10
R19	852-312474-001	Resistor, 470K Ohm, $\pm 5\%$, 1/4W	1
R25	852-312332-001	Resistor, 3.3K Ohm, $\pm 5\%$, 1/4W	1
R29	853-421742-031	Resistor, 17.4K Ohm, $\pm 1\%$, 1/4W	1
R30	925-042526-002	Resistor, Trim Pot, 5K Ohm	1
R31,R32	852-312204-001	Resistor, 200K Ohm, $\pm 5\%$, 1/4W	2
R33,R34	852-312203-001	Resistor, 20K Ohm, $\pm 5\%$, 1/4W	2
R35	852-312305-001	Resistor, 3 Megohm, $\pm 5\%$, 1/4W	1

INDEX OR REF
R36,R
R37,R38
R5
R39,R
R4
R41,R65
R4
R4
R48,R
R50,R54
R5
R5
R5
R56,R
R6
R6

INDEX OR REF
A1
A2
A3 thru
A9
C1,C2
C8,C
C3,C4
C9,C12
C5,C
C1
C15,C
CR2 thru
CR
CR
IC1
IC2
N1
N2
N3
N4
P1,

*MULTIMOOG TANDEM PRINTED CIRCUIT BOARD
REPLACEMENT PARTS LIST (Continued)*

INDEX NO. OR REF DESIG	PART NUMBER	DESCRIPTION	QTY
R36,R59 R37,R38,R49, R57 R39,R47 R40 R41,R65,R67 R42 R44 R48,R66 R50,R54,R63 R51 R52 R53 R55 R56,R69 R60 R61	925-042526-005 852-312103-001 852-312472-001 852-312513-001 852-312473-001 852-312243-001 852-312183-001 852-312335-001 852-312105-001 852-312515-001 852-312102-001 925-042526-003 923-042835-001 852-312333-001 851-152106-000 852-312123-001 906-040307-007 906-042012-008 980-042414-002	Resistor, Trim Pot, 100K Ohm Resistor, 10K Ohm, $\pm 5\%$, 1/4W Resistor, 4.7K Ohm, $\pm 5\%$, 1/4W Resistor, 51K Ohm, $\pm 5\%$, 1/4W Resistor, 47K Ohm, $\pm 5\%$, 1/4W Resistor, 24K Ohm, $\pm 5\%$, 1/4W Resistor, 18K Ohm, $\pm 5\%$, 1/4W Resistor, 3.3 Megohm, $\pm 5\%$, 1/4W Resistor, 1 Megohm, $\pm 5\%$, 1/4W Resistor, 5.1 Megohm, $\pm 5\%$, 1/4W Resistor, 1K Ohm, $\pm 5\%$, 1/4W Resistor, Trim Pot, 100K Ohm Resistor, Selected, $\pm 5\%$, 1/4W Resistor, 33K Ohm, $\pm 5\%$, 1/4W Resistor, 10 Megohm, $\pm 10\%$, 1/4W Resistor, 12K Ohm, $\pm 5\%$, 1/4W Socket, Integrated Circuit, SIL, 7 Pin, AMP1-583773-4 Socket, Integrated Circuit, DIP, 8 Pin, AMP583640-1 Printed Circuit Board	2 4 2 1 3 1 1 2 3 1 1 1 1 2 1 1 1 2 1 1 2 2 1

*MULTIMOOG TOP PRINTED CIRCUIT BOARD
REPLACEMENT PARTS LIST*

INDEX NO. OR REF DESIG	PART NUMBER	DESCRIPTION	QTY
A1 A2 A3 thru A8 A9 C1,C2,C7, C8,C10 C3,C4,C6, C9,C12,C13 C5,C11 C14 C15,C16 CR2 thru CR4, CR5 CR6 IC1 IC2 N1 N2 N3 N4 P1,P2	996-042411-001 991-042386-001 991-041089-004 991-041102-001 991-041084-001 947-040200-103 947-042020-101 946-041978-104 947-040202-033 946-040231-001 919-041074-001 919-041075-001 991-041104-001 991-041087-001 949-042451-002 949-042452-001 949-042449-001 949-042450-001 910-042532-006	Printed Circuit Board Assembly consisting of: Integrated Circuit, Operational Amplifier, TL081 Integrated Circuit, Operational Amplifier, LM3080M Integrated Circuit, Dual Operational Amplifier, MC1458CP-1 Integrated Circuit, Dual Operational Amplifier, LM358 Capacitor, Disc, 0.01uf Capacitor, Disc, 100Pf Capacitor, Polyester, 0.1uf Capacitor, Disc, 3.3Pf Capacitor, Tantalum, 1.5uf, 20V Diode, Germanium, 1N34A Diode, 1N4148, Alternate 1N914 Integrated Circuit, Resistor Array, CA3046 Integrated Circuit, CMOS, CD4016AE Resistor Network, Oscillator A Summer Resistor Network, Inverter A Resistor Network, Routing Resistor Network, Auxiliary Oscillator and Filter Summer Connector, Printed Circuit Board, Right Angle, 6 Pin, AMP640389-6	1 1 6 1 5 6 2 1 2 1 4 1 1 1 1 1 1 1 2

MULTIMOOG TOP PRINTED CIRCUIT BOARD
REPLACEMENT PARTS LIST (Continued)

INDEX NO. OR REF DESIG	PART NUMBER	DESCRIPTION	QTY
P3 thru P5	910-042532-008	Connector, Printed Circuit Board, Right Angle, 8 Pin, AMP64089-8.	3
Q1,Q8	991-041052-001	Transistor, PNP, 2N3906	2
Q2	991-041055-001	Transistor, N Channel FET, E112	1
Q9	991-041051-001	Transistor, NPN, 2N3904	1
R1	852-312303-001	Resistor, 30K Ohm, $\pm 5\%$, 1/4W	1
R2	852-312152-001	Resistor, 1.5K Ohm, $\pm 5\%$, 1/4W	1
R3	925-042550-009	Resistor, Rotary Pot, Special D, 15K Ohm	1
R4,R84	852-312223-001	Resistor, 22K Ohm, $\pm 5\%$, 1/4W	2
R5,R70,R74	852-312473-001	Resistor, 47K Ohm, $\pm 5\%$, 1/4W	3
R6,R8	925-042550-002	Resistor, Rotary Pot, Linear, 10K Ohm	2
R7,R15,R19	852-312333-001	Resistor, 33K Ohm, $\pm 5\%$, 1/4W	3
R9,R12,R13, R17,R75,R83	852-312104-001	Resistor, 100K Ohm, $\pm 5\%$, 1/4W. (R15 changed to 20K on Later Version)	6
R10,R11,R28, R38,R77,R79	852-312105-001	Resistor, 1 Megohm, $\pm 5\%$, 1/4W	6
R14	925-042550-008	Resistor, Rotary Pot, Linear, 8K Ohm	1
R16,R21,R24, R65	925-042526-005	Resistor, Trim Pot, 100K Ohm	4
R18	852-312243-001	Resistor, 24K Ohm, $\pm 5\%$, 1/4W	1
R20	925-042526-003	Resistor, Trim Pot, 10K Ohm	1
R25	852-312475-001	Resistor, 4.7 Megohm, $\pm 5\%$, 1/4W	1
R26,R37,R44, R86	852-312102-001	Resistor, 1K Ohm, $\pm 5\%$, 1/4W	4
R27	852-312515-001	Resistor, 5.1 Megohm, $\pm 5\%$, 1/4W	1
R32	852-312101-001	Resistor, 100 Ohm, $\pm 5\%$, 1/4W	1
R35	853-421004-031	Resistor, 1 Megohm, $\pm 1\%$, 1/4W	1
R36	851-152156-000	Resistor, 15 Megohm, $\pm 10\%$, 1/4W	1
R41	853-421000-031	Resistor, 100 Ohm, $\pm 1\%$, 1/4W	1
R42	853-312332-001	Resistor, 3.3K Ohm, $\pm 5\%$, 1/4W	1
R43	853-312682-001	Resistor, 6.8 Ohm, $\pm 5\%$, 1/4W	1
R45	853-312471-001	Resistor, 470 Ohm, $\pm 5\%$, 1/4W	1
R46	852-312103-001	Resistor, 10K Ohm, $\pm 5\%$, 1/4W	1
R47	853-423321-031	Resistor, 3.32K Ohm, $\pm 1\%$, 1/4W	1
R48	925-042526-001	Resistor, Trim Pot, 1K Ohm	1
R49	853-421003-031	Resistor, 100K Ohm, $\pm 1\%$, 1/4W	1
R56,R59	853-224753-021	Resistor, 475K Ohm, $\pm 1\%$, 1/2W	2
R61	853-424223-031	Resistor, 422K Ohm, $\pm 1\%$, 1/4W	1
R62,R68	852-312393-001	Resistor, 39K Ohm, $\pm 5\%$, 1/4W	2
R66	852-312513-001	Resistor, 51K Ohm, $\pm 5\%$, 1/4W	1
R76	852-312204-001	Resistor, 200K Ohm, $\pm 5\%$, 1/4W	1
R78	852-312514-001	Resistor, 510K Ohm, $\pm 5\%$, 1/4W	1
R81	925-042526-004	Resistor, Trim Pot, 25K Ohm	1
R82	852-312474-001	Resistor, 470K Ohm, $\pm 5\%$, 1/4W	1
SW1,SW4,SW6	960-041752-001	Switch, Slide, 2P3T, UID	3
SW2,SW3	960-041751-001	Switch, Slide, 2P2T, UID	2
SW5	960-041754-001	Switch, Rotary, 2P6T, CTS32704-1	1
	960-040307-007	Socket, Integrated Circuit, DIP, 7 Pin, AMP1-583773-4	4
	960-042012-008	Socket, Integrated Circuit, SIL, 8 Pin, AMP 583640-1	2
	980-042410-002	Printed Circuit Board	1

GENERAL PARTS LIST

BOARDS AND ASSEMBLIES

997-041600-940	Complete Case, Micromoog
997-041471-001	Keyboard Micromoog
997-043380-001	Keyboard, Multimoog
964-042381-980	Complete Case, Multimoog
968-042334-940	Force Sensor, Multimoog
996-040122-001	Keyboard Booster Board
997-041387-001	Left Hand Controller
996-041474-001	Main Board
996-041615-001	Power Supply Board
997-040525-001	Ribbon
996-042415-001	Tandem Board
996-042411-001	Top Board

MISCELLANEOUS PARTS

964-042405-002	Access Cover, Contact Cleaning	
957-041790-005	Audio Cable, 5 foot	
962-040874-001	Base, Micromoog	904-010948 003 006
972-042397-001	Base, Multimoog	
957-041794-001	Detachable Line Cord	
972-042397-001	Foam Material to Seal-Access Cover	
915-040836-001	Knob 7/8 Inch Diameter, Skirted	
915-040837-001	Knob 1-1/8 Inch Diameter, Bar	
915-040921-001	Knob, 3/4 Inch Diameter, Push On	
993-041147-001	Owners Manual, Micromoog	
993-042558-001	Owners Manual, Multimoog	
993-040188-002	Service Manual, Micromoog	
993-040188-003	Schematics, Multimoog	
932-041642-001	Shipping Carton, Micromoog	
932-042557-001	Shipping Carton, Multimoog	
993-041181-001	S-Trig Plug	
933-041678-001	Teflon Coated Fiberglass Tape 3/4 x 4-1/2	
915-040922-001	White Glamor Cap for Switches	

KEYBOARD PARTS AND ASSEMBLIES

918-043238-001	Buss Bar, Micro & Multi Gold Plated
964-042611-001	Black Key, Sharp and Flat
964-041418-003	White Key, A
964-041418-004	White Key, B
964-041418-005	White Key, C
964-041418-006	White Key, D
964-041418-007	White Key, E
964-041418-008	White Key, F
964-041418-009	White Key, G
964-041418-010	White Key, High C
917-043250-001	"J-Wire" contact, Gold Plated
916-041636-001	Keyboard Grommet Strip - 17-3/4 Inch

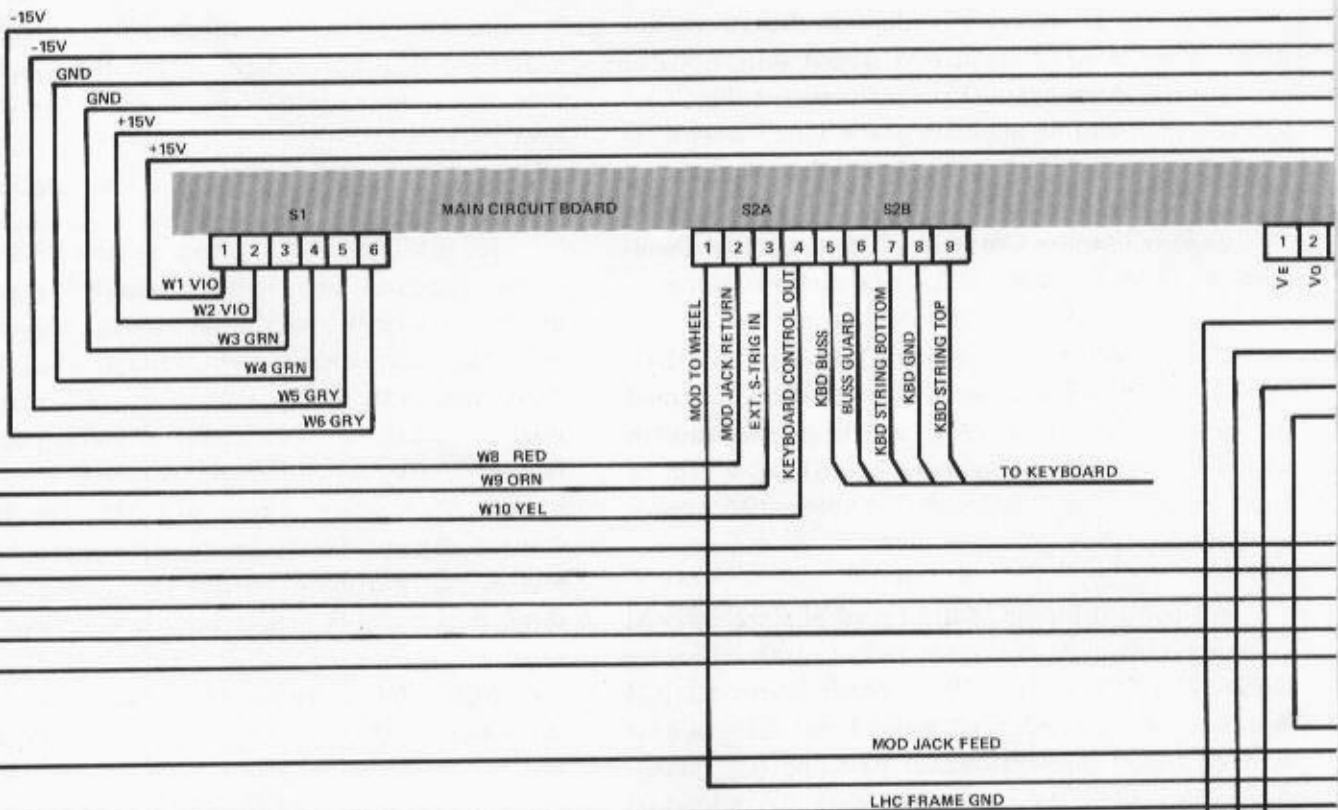
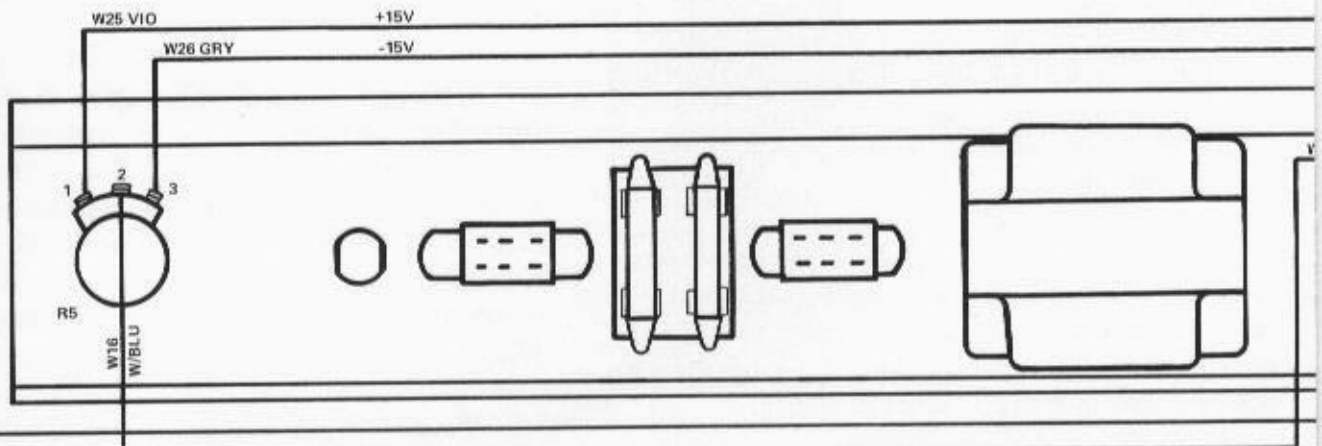

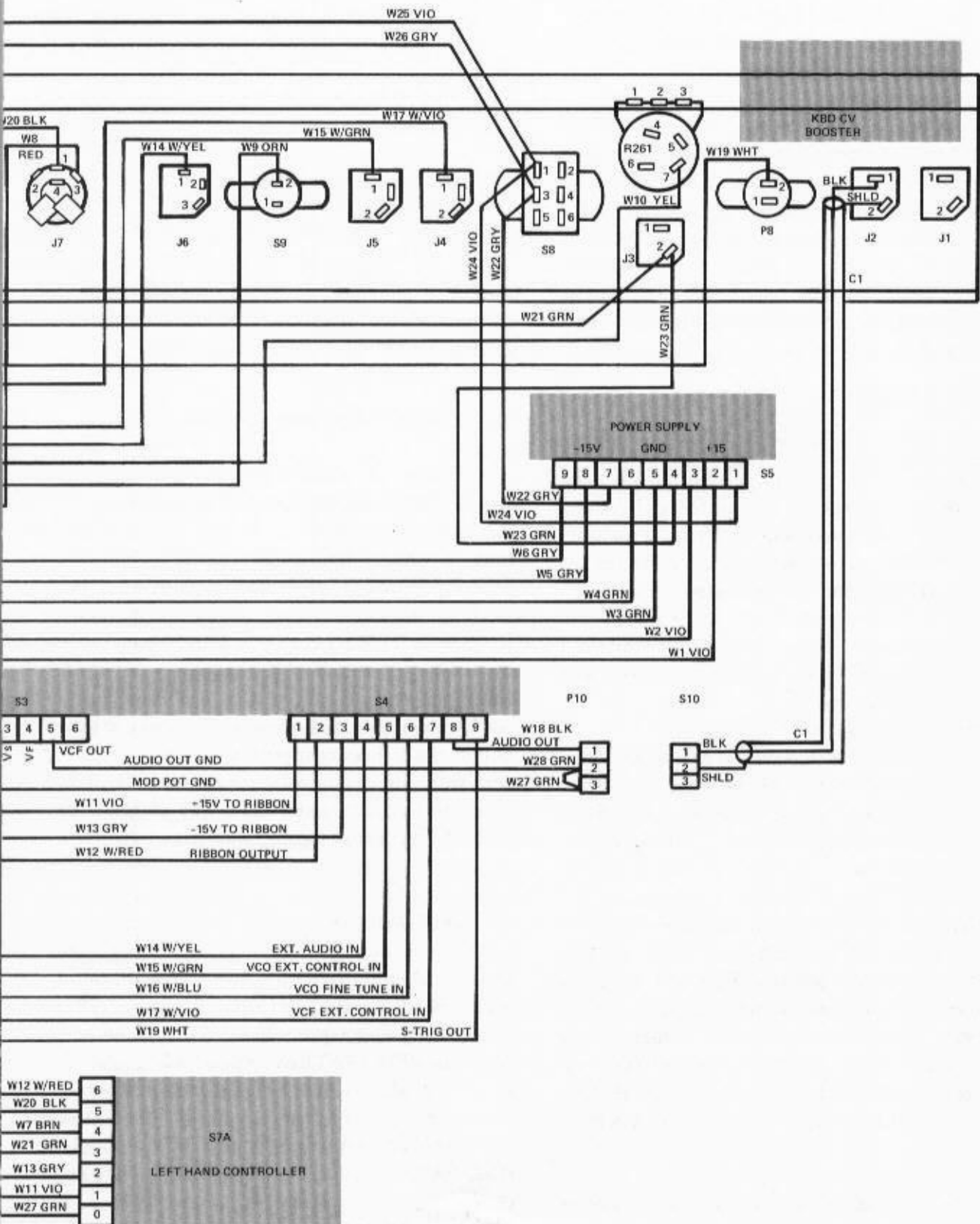

FIGURE 6-2 MICROMOOG INTERCONNECT HARNESS ASSEMBLY

MULTIMOOG CIRCUIT DESCRIPTION

TOP BOARD 2

MIX A-B

The MIX A-B control allows panning from Oscillator A only to Oscillator B only with A equal to B at the center position.

Oscillator B output (pin 6 on main board) is applied to P25-8 and FET input buffer A1. The buffered output drives the CW end of "Mix A-B" potentiometer R3. Oscillator A (located on Board 3) drives the CCW end of R3. Wiper of R3 through summing resistor R4 leaves via P25-7 and arrives at pin 7 on the main board completing the audio path to VCF.

OSCILLATOR A SUMMING

This circuit is identical to oscillator summer described in main board circuit description with the exception of the control voltages added and protection transistors Q307 and Q308. These transistors were eliminated because this summing node has no external inputs that could be overloaded.

Control voltages that are added are comprised of Oscillator B Master Control, Interval, Ribbon, and Force Sensor modulation.

Master Oscillator B imposes all its summed control voltages on Oscillator A. Oscillator B control, at 1V/octave, is buffered by A4B to avoid loading and applied to summing node by R22 and scale trim potentiometer R20.

INTERVAL control R14 has range $\pm 15V$ which is inverted and reduced to $\pm 4.95V$ by R17, R18, R19, and A4A. Resistor R23 and trim potentiometer R21 set span of interval to $\pm 5.83\mu A$ or \pm a fifth. Resistor R15 and trim potentiometer R16 compensate for non-linearities in taper of potentiometer R14 and offset of A4A. With R14 set to exact mechanical center, output of A4A will be 0.000V.

Switch SW6 RIBBON ROUTE applies ribbon control to Oscillator A and B, none, or Oscillator A only. With SW6 in the A and B position, buffered ribbon control voltage from Board 3 (P33-3) is connected to P2/2, (main board) master Oscillator

B control input. Because all control voltages summed by Oscillator B summer are also applied to Oscillator A, ribbon controls both oscillators. Center position of SW6 provides no connection. Oscillator A only position connects same buffered ribbon output to Oscillator A summer, R79 and trim pot R81 scale ribbon for the same pitch span as untrimmed A and B range (\pm a fifth approximately).

OSCILLATOR A CURRENT SOURCE

Current source, consisting of IC1, A6, Q8, CR2, CR4, R32, R35 through R38, R42 through R49, C10 and C11, is identical to dual exponential current source described in main board circuit description except VCF half is not used.

FORCE SENSOR (F.S.) MODULATION

Source of modulation is modulation source switch SW801 on main board. This modulation travels through F.S. modulation in jack J15 to P25-3 and then to voltage divider R1 and R2 to input of A2. Jack J15 provides the capability of using an external modulation source. Force sensor circuit (Board 3) provides a 0-6V maximum voltage control at P25-4, which is proportionately changed to current by R5 and Q1 to control gain of A2. Capacitor C3 suppresses oscillation, and load resistor R13 was selected to obtain the following approximate levels at A2 output with force sensor control at maximum (+6V at P25-4). Bend 0-11V, filter contour 0-11V, \square 9V peak-to-peak, \wedge 18V peak-to-peak, and S and H 18V peak-to-peak.

EFFECTS switch SW1 selects output of A2, none, or a straight bend (F.S. output directly) which is then buffered by A3B whose output drives AMOUNT potentiometer R6. Resistor R13 references A3B at ground when SW1 is in center (off) position. DESTINATION switch SW5 routes modulation from R6 to selected destination. To facilitate lines, two Auxiliary summers were included. Auxiliary Oscillator summer consisting of R56 through R60, R62, R69, R70, R72, A7A and A7B adds external oscillator input and force modulation. Auxiliary filter summer consisting of R61, R63 through R68, R71, R73, R74, A8A and A8B add external filter input and force modulation. These two summers drive master Oscillator B and filter summers on main

board. Summing resistors were selected to obtain the following sensitivities:

Oscillator A and B	4.5V/octave
Oscillator A	9V/octave
Oscillator A and B plus Filter	4.5V/octave
Filter	0.5V/octave
Synchronization (Oscillator A)....	2.0V/octave
Waveshape A	6V = 100%

Resistors R50 through R55 minimize offset effects of A7A and A8A, and resistors R58 and R64 offset entire instrument down 1 octave to make the second C up from the bottom of keyboard, with octave switch in 8' range, equal to 260Hz.

SYNCHRONIZATION

In the Synchronization mode the following changes occur:

- a) Oscillator A is reset by Oscillator B.
- b) Range of Interval control is shifted to approximately 1 or 2 semitones below unison with Oscillator B, with Interval potentiometer fully CCW, and the span will be approximately 1 or 2 semitones more than 3 octave above Oscillator B's frequency.
- c) Force sensor will control frequency of Oscillator A only.

Oscillator B (on main board) reset pulse (-13V to +13V 6 usec wide) is applied to P22-3 and coupled to summing amplifier A9A which in conjunction with R77 and R439 (on main board) has a gain of approximately 0.2. Capacitor C14 keeps A9A output from ringing severely.

All control inputs of IC2 (quad bilateral switch) in Synchronization mode are pulled up to +15V by DESTINATION switch SW5, which biases all IC2 switches on. Inverted reset pulse from A9A is now coupled to Q9 through resistor R83 and IC2. Transistor Q9 inverts the reset pulse back to its original polarity and diode CR6 provides a logical OR function with Oscillator A's own reset pulse. Resistor R82 biases Q9 into saturation when DESTINATION switch is not in "Synchronization" position (IC2 off), pulling collector to ground, which back biases CR6 to prevent loading of the Oscillator A reset pulse.

Range offset for Interval control is provided by R79 one end of which is tied to V+ through IC2 and increased span is obtained by paralleling R21 and R23 with R78 through IC2.

Oscillator A force sensor pitch bending comes from DESTINATION switch and connected to summing node via R76 and IC2. Diode CR5 prevents voltage at IC2 input from becoming more negative than -0.2V when DESTINATION switch is in position other than "Synchronization". Allowing voltage to go further negative would cause leakage through IC2.

Waveshape potentiometer R8 supplies voltage control to a waveshaper located on Board 3.

Amplifier A3A, C5 and R9 through R11 provide 1 megohm input impedance buffer for External Audio Input jack J14. Output of A3A is interconnected to filter input on main board.

GLIDE ON/OFF switch SW2 controls FET switch on main board. GLIDE jack J11 has also been included which requires SW2 to be in the OFF position to function.

KYBD/TRIG EXT output switch SW4 provides on/off function for keyboard control voltage out, external S-trigger and ribbon control voltage mixed with the keyboard control voltage out. Amplifier A9B, Q2, R26, R27, R28, CR1, C7 and C8 are used to switch keyboard control voltage to prevent false triggering when SW4 is switched. When driving a slave Micromoog, direct switching the keyboard control voltage would produce large rapid DC offsets at the keyboard output jack, coupling to the slaves trigger circuit generating a false trigger.

With SW4 in either ON position, the gate of Q2 is held at the source potential by R27 biasing Q2 which closes the feedback loop of A9B creating a unity gain buffer. Sliding SW4 to the OFF position pulls the gate of Q2 down toward V- which turns Q2 off and opens the feedback loop of A9B thus allowing P32-2 to float. Capacitor C8 in conjunction with R27 and R28 slow down the on-to-off and off-to-on transitions preventing false triggering of the slave unit.

TANDEM BOARD 3 OSCILLATOR A AND WAVESHAPER A

These circuits are identical to Oscillator B and Waveshaper B described in the main board circuit description.

FORCE SENSOR

The FORCE sensor mechanism, mounted underneath the keys, has a 26-inch long anodized aluminum rod on which a key bears when it is fully down (bottomed). Excess key pressure forces the rod to compress its foam rubber support pad causing the rod to come into more intimate contact with the grounded conductive nylon strip glued to the foam rubber pad. The assembly functions as a variable capacitor and the more force with which one holds a key down, the greater the capacitance. The FORCE sensor circuit senses this capacitance increase and produces a DC control voltage ranging from 0 (no excess pressure) to +6 volts (maximum pressure) at P25-4 and J10.

VARIABLE FILTER AND AVERAGE VALUE DETECTOR

Multivibrator IC1 produces a square wave at a nominal frequency of 50kHz. The FORCE sensor element is a variable capacitance connected across P32A-1 and ground. The FORCE sensor element and R44 form a variable low pass filter wherein the peak-to-peak voltage at P32A-1 decreases as the capacitance of the variable FORCE sensor increases. Capacitor C12 couples the waveform to clamp CR6. The DC component of the signal appearing at CR6 becomes less negative as the FORCE sensor's capacitance is increased. Resistor R46 and capacitor C13 filter out the AC components leaving only the DC component of the signal to be applied to emitter follower Q6. Resistor R47 at the emitter of Q6 and C4 provides additional filtering of the output signal.

DC RESTORER

The keyboard circuitry generates a trigger voltage which is applied to P31-4 whenever a key is depressed. With no key depressed, this voltage is zero, Q8 conducts and A6 turns on. The voltage at the junction of R47 and R49 (pin 2 of A6) is kept very

close to zero when the input trigger is zero through a feedback loop consisting of Q7 and R49.

Whenever any key is depressed, the trigger voltage at P31-4 rises to +13.5 volts and Q8 shuts off, shutting off A6. Capacitor C17 holds the voltage that existed before the trigger appeared and the junction of R47 and R49 remains close to zero until the FORCE sensor element capacitance increases. When the element's capacitance begins to increase (as a result of pressing down harder upon a key) the voltage at the junction of R47 and R49 begins to rise. Thus, A6, Q7 and Q8 and related circuitry form a DC restorer that keeps the voltage at the junction of R47 and R49 at zero until a key is depressed and returns it to zero when a key is released.

AMPLIFIER

The voltage at the junction of R47 and R49 is applied to open loop amplifier A7. Resistor R53 is set so that the input of A7 begins to saturate when the FORCE control output rises to approximately 50 percent of its maximum value and saturates more and more as the FORCE sensor element is depressed further. This allows the FORCE sensor to be more sensitive at the beginning of its travel and to become increasingly less sensitive as a key is depressed with more force. The force control output from pin 6 of A7 is applied to R57, C21 and C22 to Board 2 and J10.

Resistor R57 and capacitor C21 form 22msec time constant which causes force sensor control voltage to decay somewhat gradually.

MULTIMOOG TRIGGER CIRCUIT

Whenever a key is held down and then a lower note depressed (2 keys down) an abrupt change in control voltage on the keyboard buss occurs (minimum change, 1 semitone or 83mV). This control voltage change is AC coupled to A8A through R58 and C24. Resistor R62 and capacitor C25 filter out spikes less than 1msec that are normally associated with contact bounce. The resultant waveform applied to A8A is rounded and negative going. Similarly when the depressed key is released, without releasing the first key, another abrupt control voltage change will occur only positive going. These rounded

spikes are amplified by A8A which drives A8B through R64, CR7 and CR8. Resistors R65 and R66 set a 200mV threshold and CR7 and CR8 assure that the output of A8B will always be positive going by only coupling positive spikes to the non-inverting input and negative spikes to the inverting input. Resistor R68 and capacitor C26 form the 10msec one-shot that fires Q9, the collector of which is routed through the TRIG mode switch SW3 (on Board 2) and logically "ORed" with the single trigger circuit output (on main board). The Q9 collector pulling to ground causes a 10msec loss of single trigger; therefore, single trigger coming back up will be a new trigger.

KEYBOARD AND RIBBON CONTROL VOLTAGE OUT SUMMERS

Ribbon control voltage, from left-hand controller, appears at P33-5 and input of buffer A4A. Load resistor R32 (in conjunction with R1004 on left-hand controller) was chosen to yield a ribbon control voltage span of $\pm 1.5V$ nominal. A4A drives RIBBON ROUTE switch SW6 (on Board 2) and rear panel "Ribbon Out" scale potentiometer R70 which varies scale $\pm 20\%$. Amplifier A4B buffers control

voltage at R70 wiper and provides low impedance drive for ribbon out jack. Resistor R29 and "Ribbon Mix" Adj trimpot R30 (which is set such that when Oscillator A is swept a fifth, the slave unit is also swept a fifth) are connected through (when in on and ribbon position) SW4 (on Board 2) to control voltage coming directly from the main board. Amplifier A5B inverts summed control voltage to original polarity and incorporates a rear panel scale potentiometer and switch R43. In the click position there will be no ribbon control voltage summed and keyboard control voltage originates directly from the main board. Potentiometer R71 provides a scale variation of $\pm 10\%$ and switch wiper is routed through SW4, A9B and Q2 (all on Board 2) to control voltage out jack J8. Trimpot R36 has been included to provide slight ($\pm 40mV$) range adjustment of control voltage out. This compensates for offset variations in the FET input buffer used in the keyboard circuit.

NOTE

To force a control voltage into the keyboard output jack SCALE potentiometer must be in the click position and SW4 (on Board 2) in one of its ON positions.

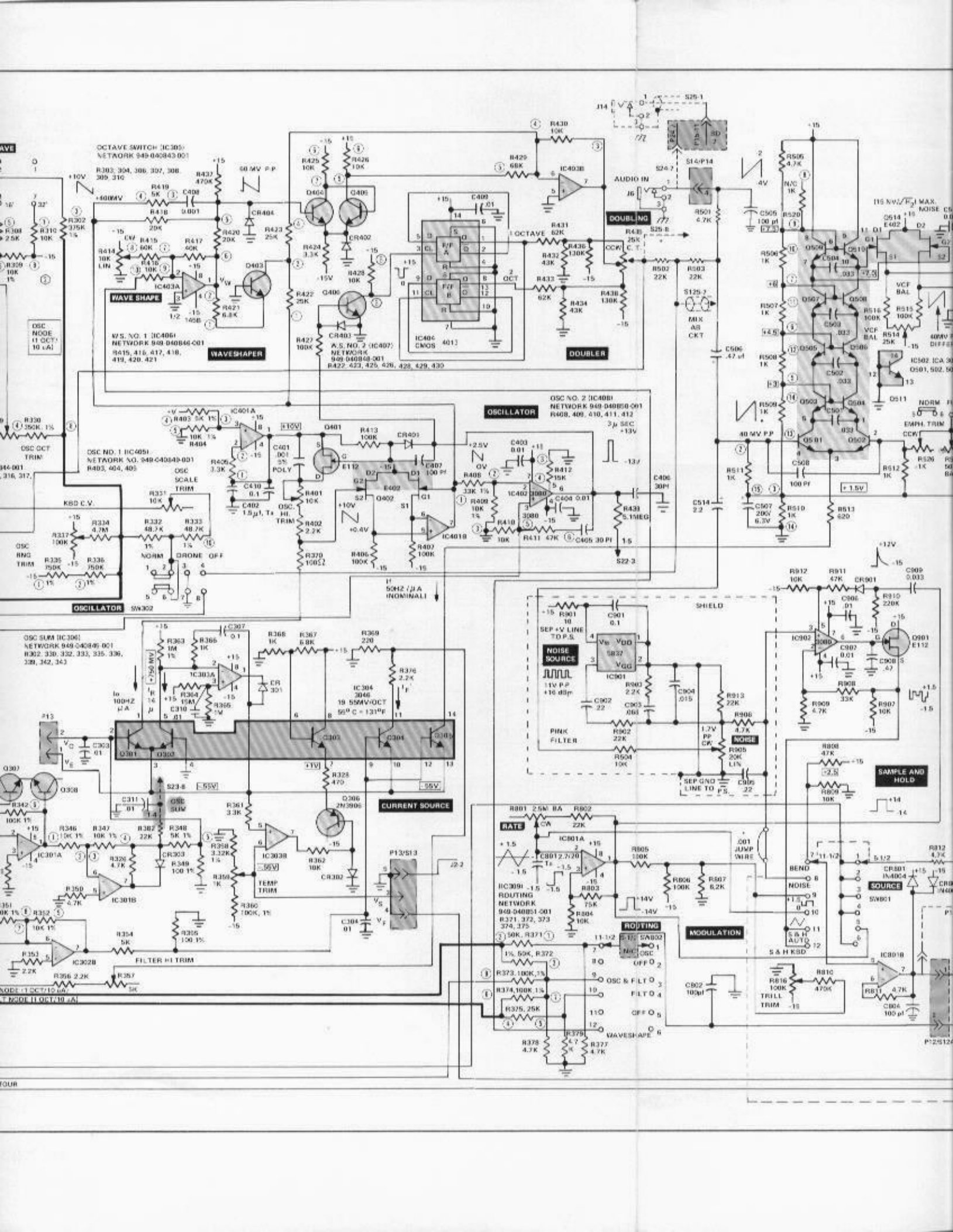

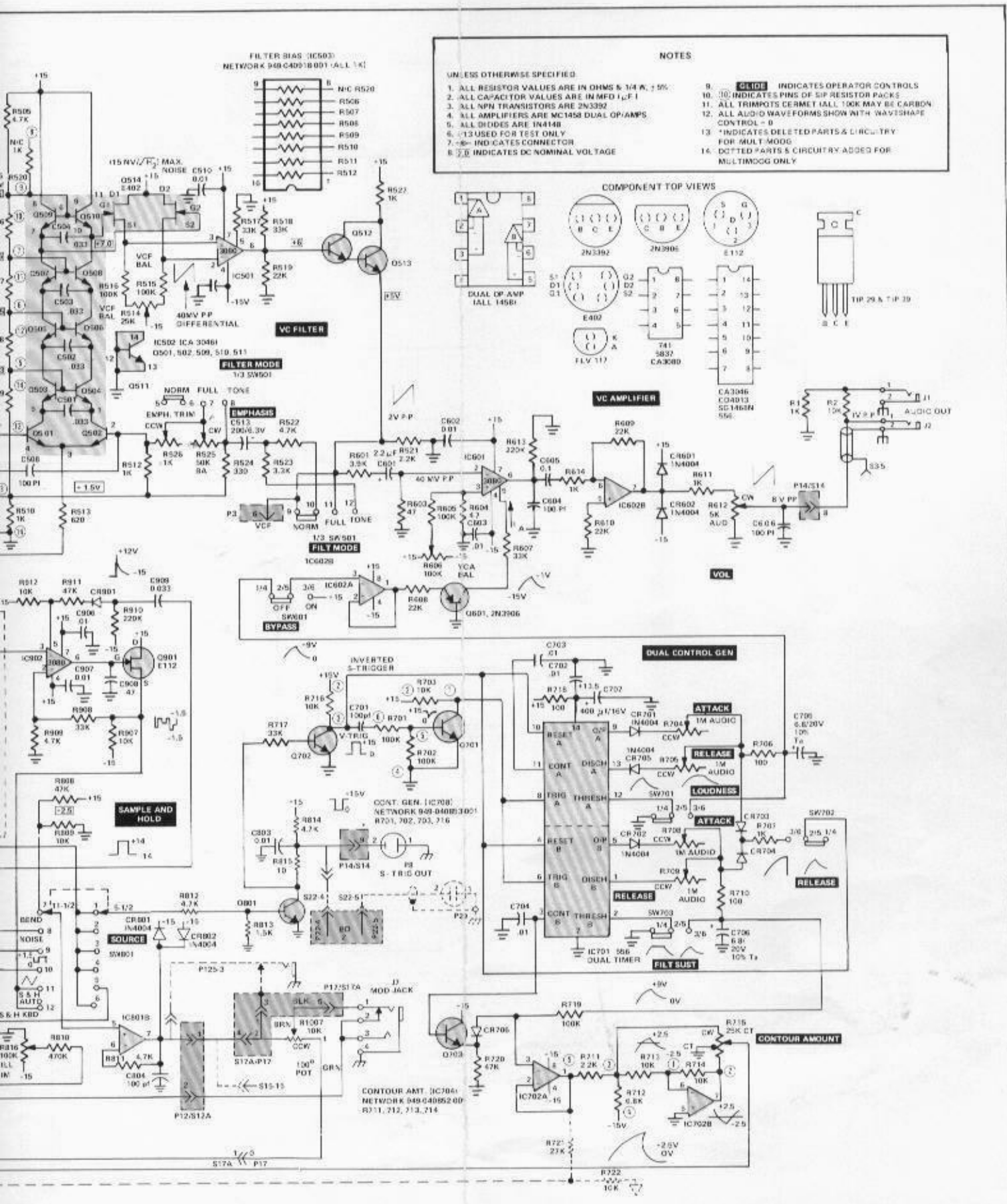

- NOTES**
- UNLESS OTHERWISE SPECIFIED:
1. ALL RESISTOR VALUES ARE IN OHMS & 1/4 W, ±5%
 2. ALL CAPACITOR VALUES ARE IN MFD 10% E I
 3. ALL NPN TRANSISTORS ARE 2N3902
 4. ALL AMPLIFIERS ARE MC1458 DUAL OP/AMPS
 5. ALL DIODES ARE 1N4148
 6. -13 USED FOR TEST ONLY
 7. -14 INDICATES CONNECTOR
 8. 7-E INDICATES DC NOMINAL VOLTAGE
 9. **GLIDE** INDICATES OPERATOR CONTROLS
 10. **10** INDICATES PINS OF DIP RESISTOR PACKS
 11. ALL TRIMPTS CERMET (ALL 100K MAY BE CARBON)
 12. ALL AUDIO WAVEFORMS SHOW WITH WAVESHAPES CONTROL - B
 13. *INDICATES DELETED PARTS & CIRCUITRY FOR MULTIMOD
 14. DOTTED PARTS & CIRCUITRY ADDED FOR MULTIMOD ONLY

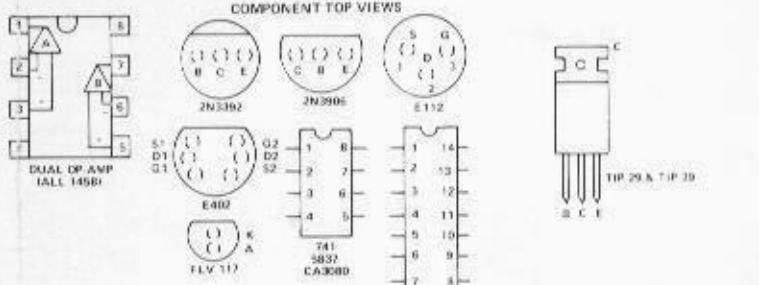
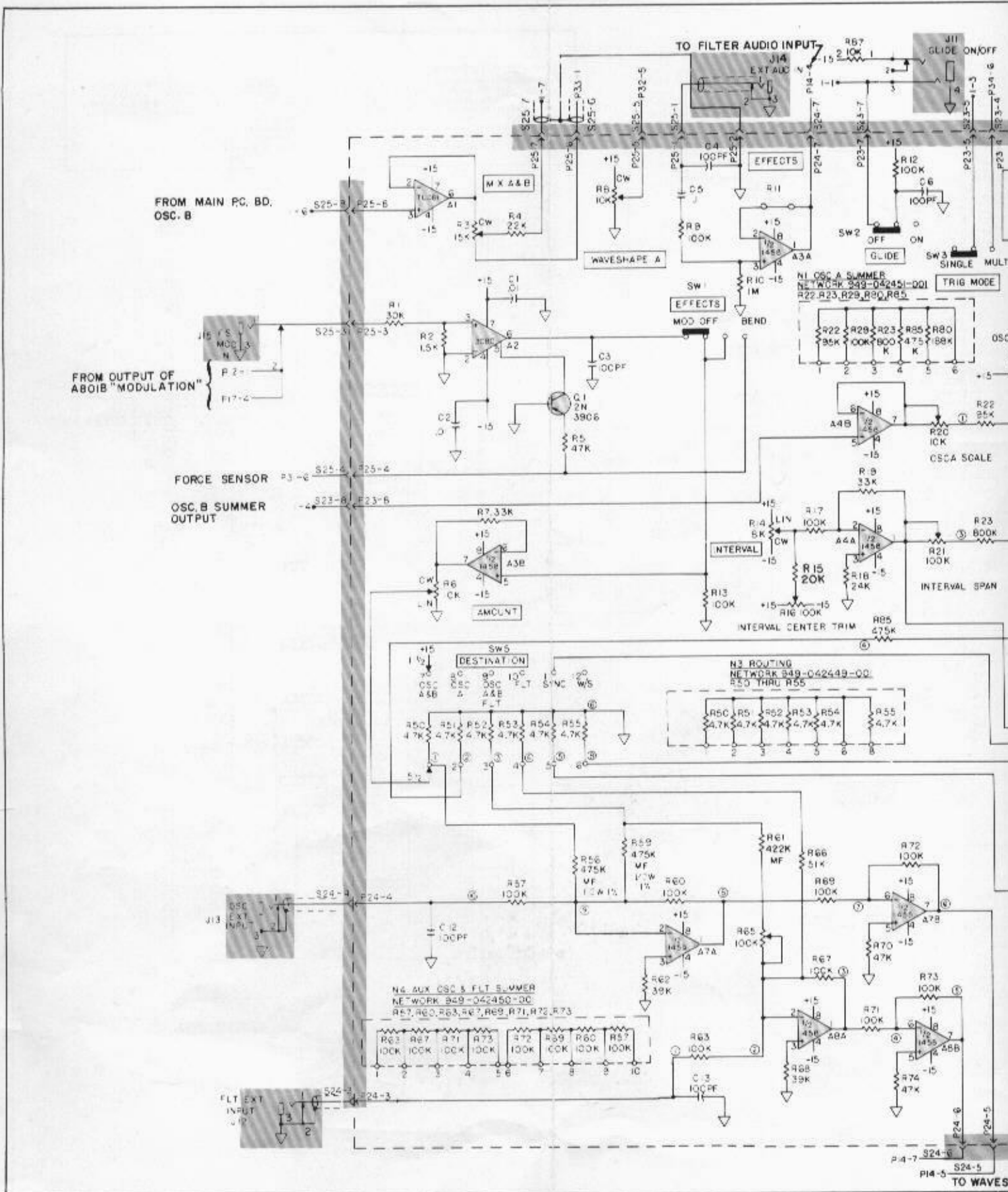

FIGURE 6-3 MICROMOG SCHEMATIC DIAGRAM



FROM MAIN PC. BD.
OSC. B

FROM OUTPUT OF
ABOIB "MODULATION"

FORCE SENSOR

OSC. B SUMMER
OUTPUT

TO FILTER AUDIO INPUT

J11
GLIDE ON/OFF

N1 OSC A SUMMER
NETWORK 349-042451-001
R22, R23, R29, R80, R85

TRIG MODE

OSC A

OSC B

CSCA SCALE

INTERVAL SPAN

INTERVAL CENTER TRIM

DESTINATION

N3 ROUTING
NETWORK 349-042449-001
R50 THRU R55

N4 AUX OSC & FLT SUMMER
NETWORK 349-042450-001
R67, R68, R63, R67, R69, R71, R72, R73

FLT EXT
INPUT

TO WAVESH

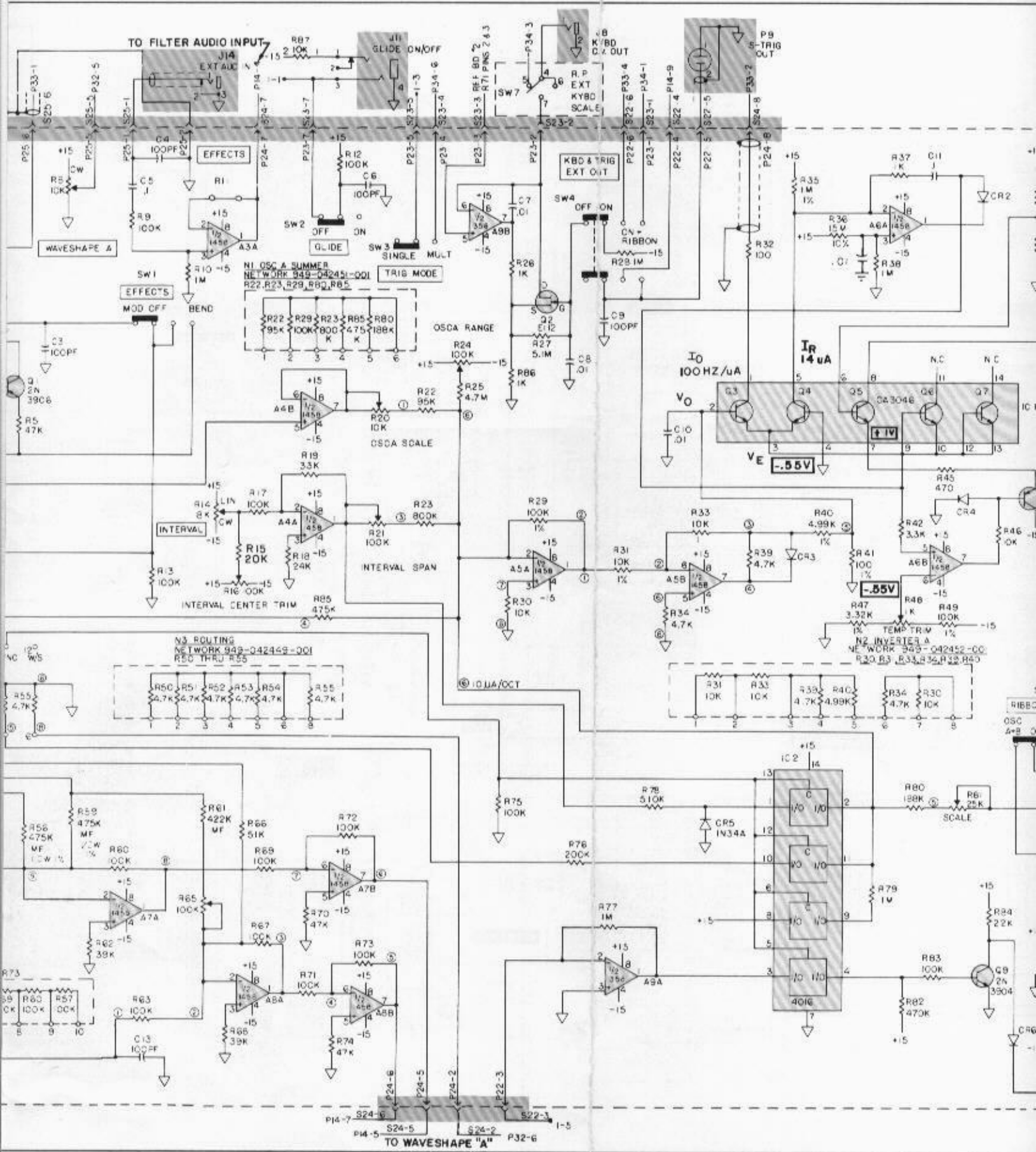

TO WAVESHAPE "A"

NOTES:

1. UNLESS OTHERWISE SPECIFIED ALL RESISTORS ARE IN OHMS 1/4W ± 5%. ALL CAPACITORS ARE MFD (UF). ALL DIODES ARE IN4148.
2. \rightarrow DENOTES P.C. BOARD WIRE CONNECTOR DESIGNATOR.

COMPONENT BASING TOP VIEW

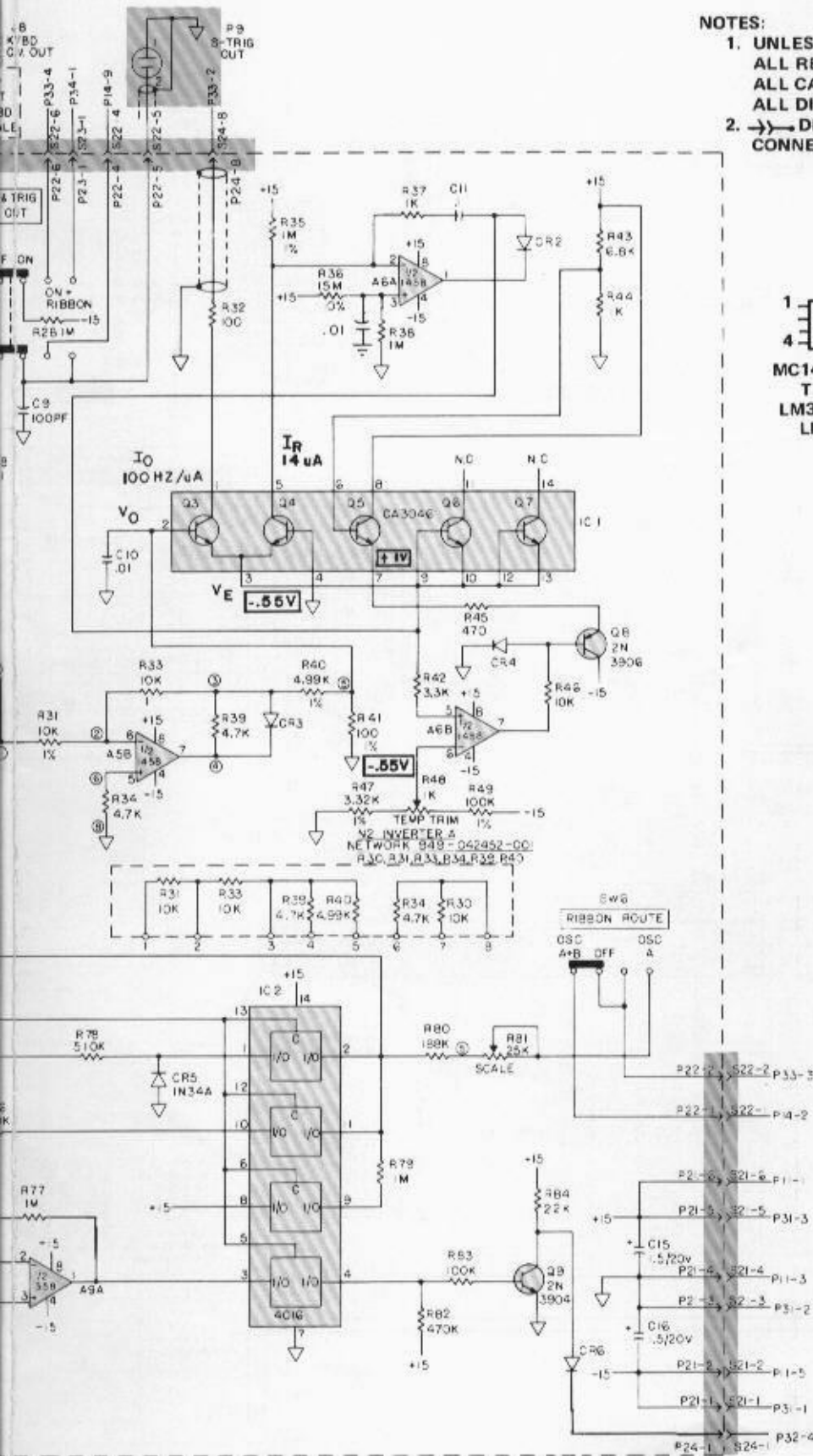
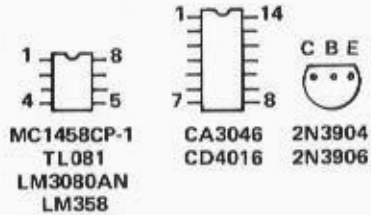

TO SOURCE

P24-B S33

P25-5 S32B

P24-2 S32B

P22-6 S33

P22-2 S33

RIBBON CV

P17A-E S33

P23- S34

KBD CV

P12-4 S34

SW7-5 S34

REF BD

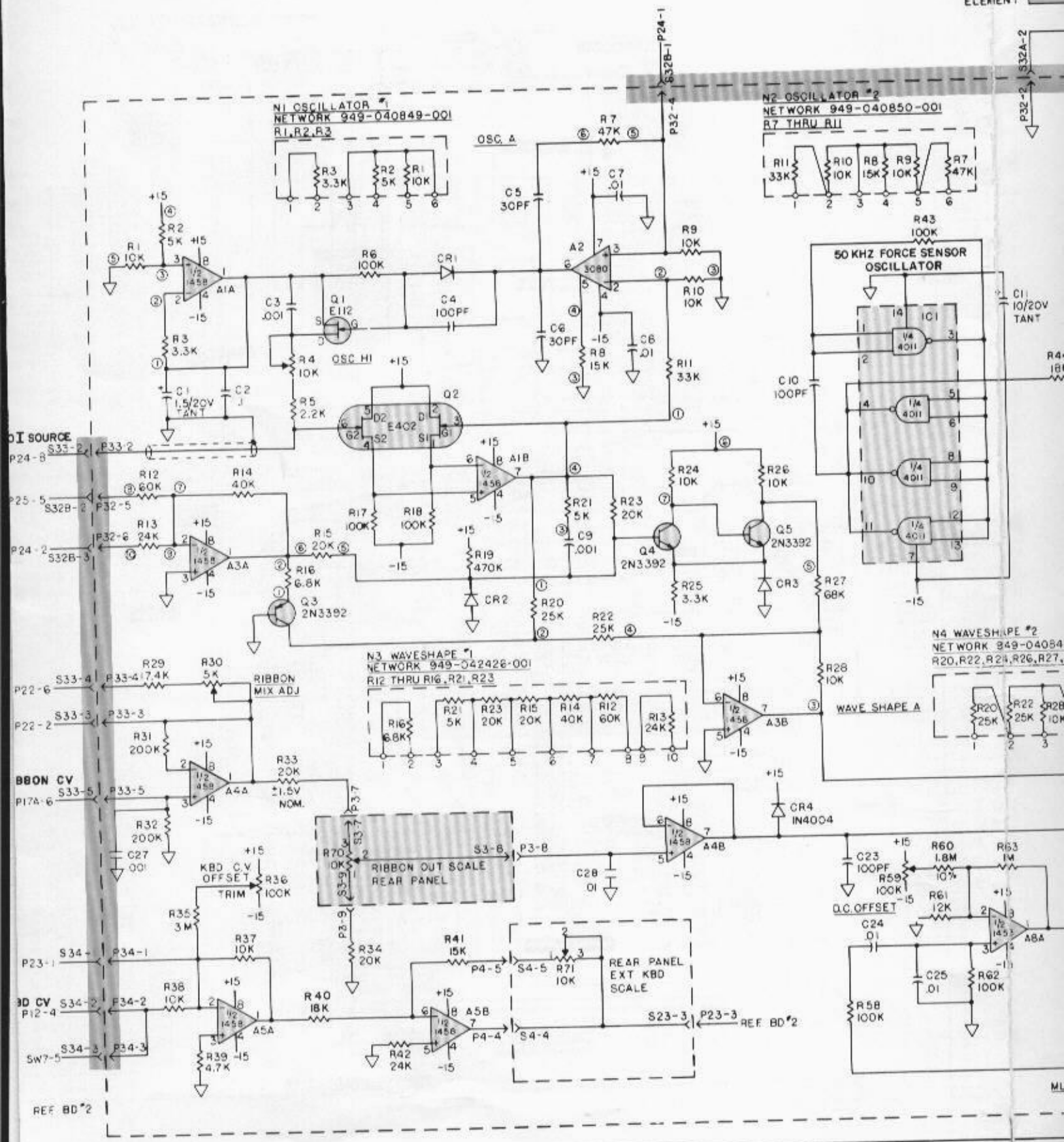

NOTES:

1. UNLESS OTHERWISE SPECIFIED ALL RESISTORS ARE IN OHMS 1/4W ± 5%. ALL CAPACITORS ARE IN MFD (UF). ALL DIODES ARE IN4148.
2. → DENOTES P.C. BOARD WIRE CONNECTION DESIGNATOR.

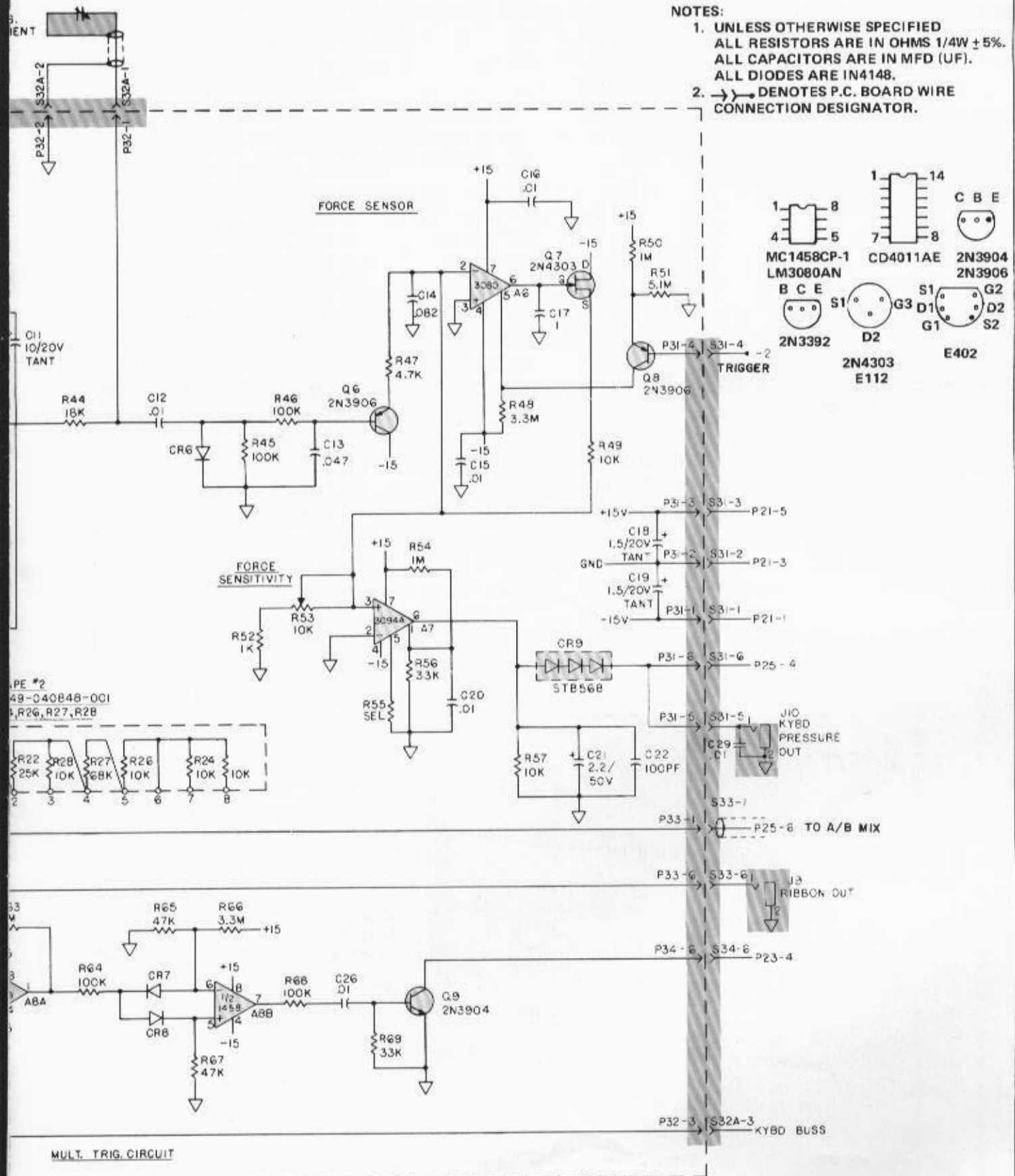

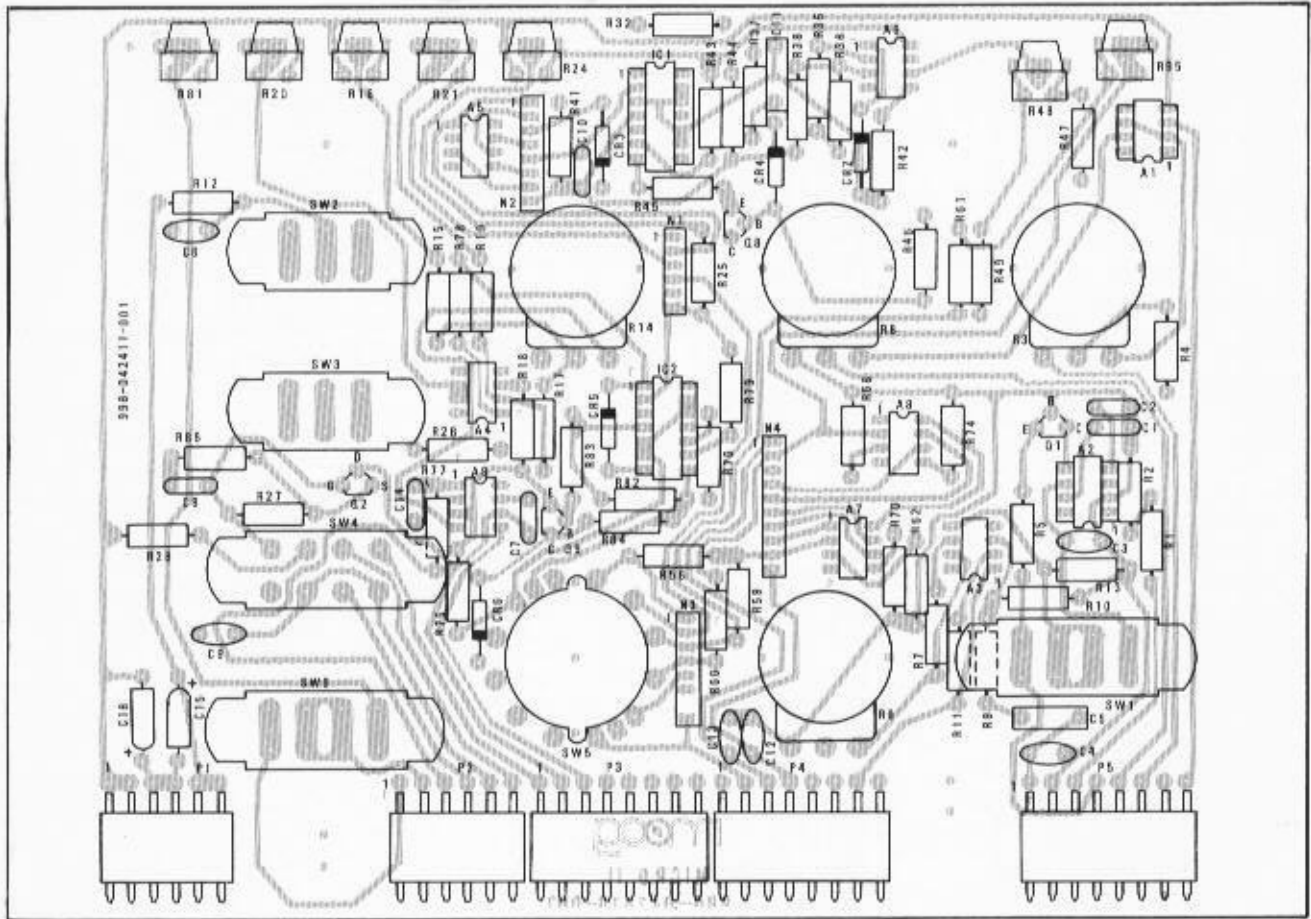

MULTIMOOG TOP PRINTED CIRCUIT BOARD NO. 2

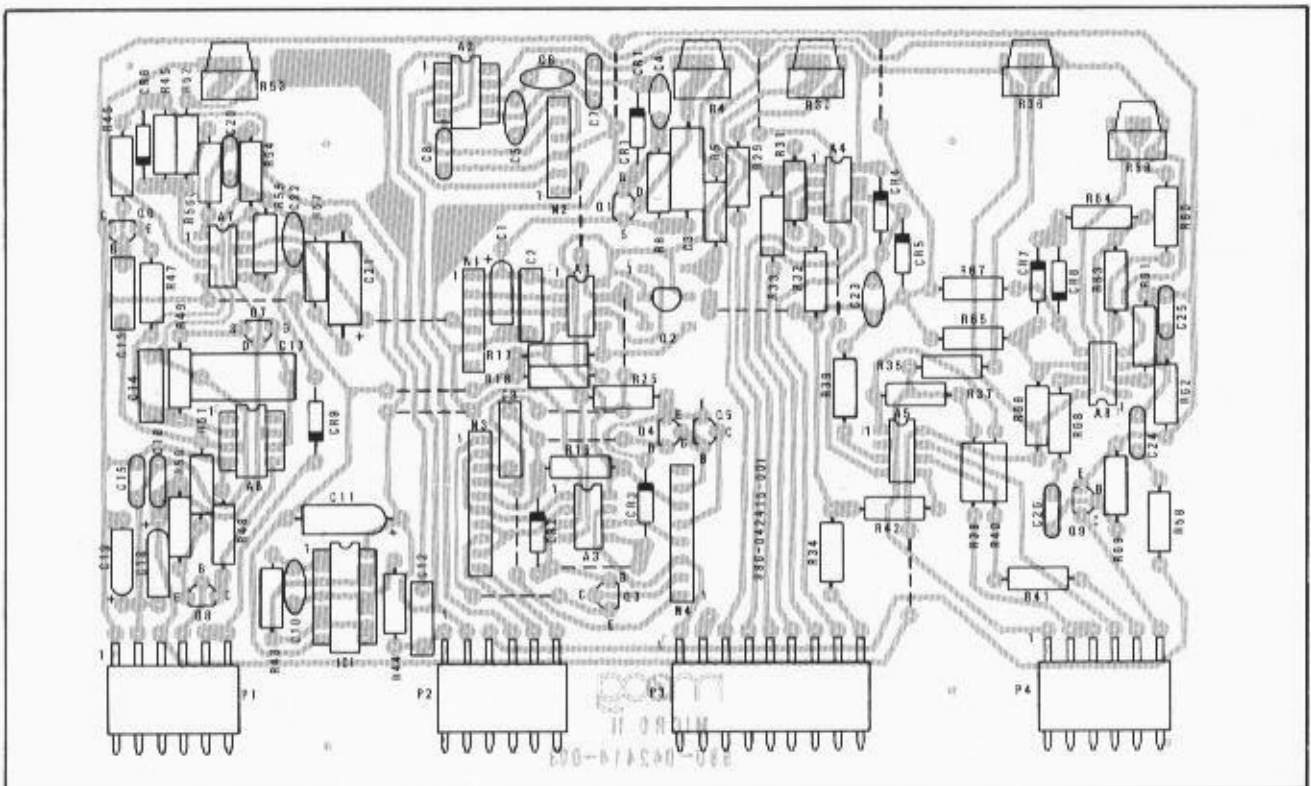

MULTIMOOG TANDEM PRINTED CIRCUIT BOARD NO. 3

MICROMOOG/MULTIMOOG SYNTHESIZER

MOOG MUSIC INC.

2500 Walden Avenue, Buffalo, New York 14225

NORLIN MUSIC INSTRUMENTS LIMITED

51 Nantucket Blvd., Scarborough, Ontario, Canada M1P 2N6

NORLIN MUSIC SERVICES B.V.

Waalhaven, Zuidzijde 48, 3088 H. J., Rotterdam, The Netherlands